



**NONRESIDENT
TRAINING
COURSE**

January 1993



Seaman

NAVEDTRA 14067

Although the words “he,” “him,” and “his” are used sparingly in this course to enhance communication, they are not intended to be gender driven or to affront or discriminate against anyone.

DISTRIBUTION STATEMENT A: Approved for public release; distribution is unlimited.

COMMANDING OFFICER
NETPDTC
6490 SAUFLEY FIELD RD
PENSACOLA, FL 32509-5237

ERRATA #1

23 Jul 1999

Specific Instructions and Errata for
TRAMAN

SEAMAN

1. No attempt has been made to issue corrections for errors in typing, punctuation, etc.

2. In the TRAMAN, make the following changes:

<u>Page</u>	<u>Column</u>	<u>Change</u>
1-7	1	In the paragraph titled "FOR WATCH" last sentence, change the word "heading" to read "hearing."
1-7	2	In the first paragraph of the topic titled "LOOKOUT AND SOUND-POWERED TELEPHONE TALKER WATCHES," change NAVEDTRA number "10045F" to read "12043" and NAVEDTRA number "14005" to read "12097."
4-5	2	In the first paragraph, first sentence, change "figure 5-4" to read "figure 4-4."
4-31	2	In figure 4-26, change the word "WATER" in the first column to read "FEEDWATER." Change the corresponding NIGHT LIGHT BOX in column 3 of figure 4-26 to display all three lights in the top row, the first two lights in the second row, and the first light in the bottom row.
5-15	1	Change paragraph 5 to read as follows: "The general call for all boats to return to their ships is QUEBEC hoisted singly."
5-20	2	Change paragraph 1 to read as follows: "Stand-on vessel refers to any power-driven vessel in a crossing situation close enough to involve risk of collision; the vessel being on the starboard side of another vessel is the "stand-on" vessel, the vessel should maintain course and speed."

Anywhere "COMDTINST M16672.2B" appears in your training manual, change it to read "COMDTINST M16672.2c."

Anywhere "*Boatswain's Mate*, Volume 1, NAVEDTRA 10101" appears, change to read "*Boatswain's Mate*, NAVEDTRA 12100."

Anywhere "NWP 14" appears, change to "NWP 4-01.4."

COMMANDING OFFICER
NETPDTTC
6490 SAUFLEY FIELD RD
PENSACOLA, FL 32509-5237

ERRATA #2

22 May 2000

Specific Instructions and Errata for
Nonresident Training Course

SEAMAN

1. This errata supercedes all previous erratas. No attempt has been made to issue corrections for errors in typing, punctuation, etc., that do not affect your ability to answer the question or questions.

2. To receive credit for deleted questions, show this errata to your local course administrator (ESO/scorer). The local course administrator is directed to correct the course and the answer key by indicating the questions deleted.

3. Assignment Booklet

Delete the following questions, and leave the corresponding spaces blank on the answer sheets:

1-8	1-44	2-45	3-41	4-22
1-30	2-38	3-12	3-70	4-28

Make the following changes:

<u>Page</u>	<u>Question</u>	<u>Change</u>
4	1-34	Change "helmsman" to read "lee helmsman"
5	1-42	Change "zero" to read "-1"
5	1-51	Change answer number 4 to read "88°"
7	1-65	Change "helmsman" to read "lee helmsman"
8	Top of Page	Change to read "pages 2-14" vice "pages 2-11"
24	4-46	Change to read "areas" vice "countries"
24	4-49	Change to read "diameter" vice "circumference"
24	4-51	Change to read "inches" vice "ft" in answers 1 through 4
25	4-60	Change question to read "A modern magazine sprinkler uses approximately how many galls of water per minute per square foot to wet down all exposed bulkheads?"
26	4-73	Change to read "Mk 42" vice "Mk 45"

PREFACE

By enrolling in this self-study course, you have demonstrated a desire to improve yourself and the Navy. Remember, however, this self-study course is only one part of the total Navy training program. Practical experience, schools, selected reading, and your desire to succeed are also necessary to successfully round out a fully meaningful training program.

COURSE OVERVIEW: In completing this nonresident training course, you will demonstrate a knowledge of the subject matter by correctly answering questions on the following: the various shipboard watches and watchstander's equipment; the fundamentals of marlinespike seamanship, deck seamanship, and boat seamanship; ammunition and gunnery, and the principles of ammunition safety and Navy gun systems.

THE COURSE: This self-study course is organized into subject matter areas, each containing learning objectives to help you determine what you should learn along with text and illustrations to help you understand the information. The subject matter reflects day-to-day requirements and experiences of personnel in the rating or skill area. It also reflects guidance provided by Enlisted Community Managers (ECMs) and other senior personnel, technical references, instructions, etc., and either the occupational or naval standards, which are listed in the *Manual of Navy Enlisted Manpower Personnel Classifications and Occupational Standards*, NAVPERS 18068.

THE QUESTIONS: The questions that appear in this course are designed to help you understand the material in the text.

VALUE: In completing this course, you will improve your military and professional knowledge. Importantly, it can also help you study for the Navy-wide advancement in rate examination. If you are studying and discover a reference in the text to another publication for further information, look it up.

*1993 Edition Prepared by
BMC(SW) Walter B. Fillingane and
SMC(SW) Warren C. Williams*

Published by
NAVAL EDUCATION AND TRAINING
PROFESSIONAL DEVELOPMENT
AND TECHNOLOGY CENTER

**NAVSUP Logistics Tracking Number
0504-LP-026-7330**

Sailor's Creed

“I am a United States Sailor.

I will support and defend the Constitution of the United States of America and I will obey the orders of those appointed over me.

I represent the fighting spirit of the Navy and those who have gone before me to defend freedom and democracy around the world.

I proudly serve my country's Navy combat team with honor, courage and commitment.

I am committed to excellence and the fair treatment of all.”

CONTENTS

CHAPTER	Page
1. Watches	1-1
2. Watchstanders' Equipment	2-1
3. Marlinespike Seamanship	3-1
4. Deck Seamanship	4-1
5. Boat Seamanship	5-1
6. Ammunition and Gunnery.	6-1
APPENDIX	
I. Glossary	AI-1
II. References used to develop the TRAMAN	AII-1
INDEX	INDEX-1

INSTRUCTIONS FOR TAKING THE COURSE

ASSIGNMENTS

The text pages that you are to study are listed at the beginning of each assignment. Study these pages carefully before attempting to answer the questions. Pay close attention to tables and illustrations and read the learning objectives. The learning objectives state what you should be able to do after studying the material. Answering the questions correctly helps you accomplish the objectives.

SELECTING YOUR ANSWERS

Read each question carefully, then select the BEST answer. You may refer freely to the text. The answers must be the result of your own work and decisions. You are prohibited from referring to or copying the answers of others and from giving answers to anyone else taking the course.

SUBMITTING YOUR ASSIGNMENTS

To have your assignments graded, you must be enrolled in the course with the Nonresident Training Course Administration Branch at the Naval Education and Training Professional Development and Technology Center (NETPDTC). Following enrollment, there are two ways of having your assignments graded: (1) use the Internet to submit your assignments as you complete them, or (2) send all the assignments at one time by mail to NETPDTC.

Grading on the Internet: Advantages to Internet grading are:

- you may submit your answers as soon as you complete an assignment, and
- you get your results faster; usually by the next working day (approximately 24 hours).

In addition to receiving grade results for each assignment, you will receive course completion confirmation once you have completed all the

assignments. To submit your assignment answers via the Internet, go to:

<https://courses.cnet.navy.mil>

Grading by Mail: When you submit answer sheets by mail, send all of your assignments at one time. Do NOT submit individual answer sheets for grading. Mail all of your assignments in an envelope, which you either provide yourself or obtain from your nearest Educational Services Officer (ESO). Submit answer sheets to:

COMMANDING OFFICER
NETPDTC N331
6490 SAUFLEY FIELD ROAD
PENSACOLA FL 32559-5000

Answer Sheets: All courses include one “scannable” answer sheet for each assignment. These answer sheets are preprinted with your SSN, name, assignment number, and course number. Explanations for completing the answer sheets are on the answer sheet.

Do not use answer sheet reproductions: Use only the original answer sheets that we provide—reproductions will not work with our scanning equipment and cannot be processed.

Follow the instructions for marking your answers on the answer sheet. Be sure that blocks 1, 2, and 3 are filled in correctly. This information is necessary for your course to be properly processed and for you to receive credit for your work.

COMPLETION TIME

Courses must be completed within 12 months from the date of enrollment. This includes time required to resubmit failed assignments.

PASS/FAIL ASSIGNMENT PROCEDURES

If your overall course score is 3.2 or higher, you will pass the course and will not be required to resubmit assignments. Once your assignments have been graded you will receive course completion confirmation.

If you receive less than a 3.2 on any assignment and your overall course score is below 3.2, you will be given the opportunity to resubmit failed assignments. **You may resubmit failed assignments only once.** Internet students will receive notification when they have failed an assignment--they may then resubmit failed assignments on the web site. Internet students may view and print results for failed assignments from the web site. Students who submit by mail will receive a failing result letter and a new answer sheet for resubmission of each failed assignment.

COMPLETION CONFIRMATION

After successfully completing this course, you will receive a letter of completion.

ERRATA

Errata are used to correct minor errors or delete obsolete information in a course. Errata may also be used to provide instructions to the student. If a course has an errata, it will be included as the first page(s) after the front cover. Errata for all courses can be accessed and viewed/downloaded at:

<https://www.advancement.cnet.navy.mil>

STUDENT FEEDBACK QUESTIONS

We value your suggestions, questions, and criticisms on our courses. If you would like to communicate with us regarding this course, we encourage you, if possible, to use e-mail. If you write or fax, please use a copy of the Student Comment form that follows this page.

For subject matter questions:

E-mail: n314.products@cnet.navy.mil
Phone: Comm: (850) 452-1001, Ext. 1826
DSN: 922-1001, Ext. 1826
FAX: (850) 452-1370
(Do not fax answer sheets.)
Address: COMMANDING OFFICER
NETPDTC N314
6490 SAUFLEY FIELD ROAD
PENSACOLA FL 32509-5237

For enrollment, shipping, grading, or completion letter questions

E-mail: fleetservices@cnet.navy.mil
Phone: Toll Free: 877-264-8583
Comm: (850) 452-1511/1181/1859
DSN: 922-1511/1181/1859
FAX: (850) 452-1370
(Do not fax answer sheets.)
Address: COMMANDING OFFICER
NETPDTC N331
6490 SAUFLEY FIELD ROAD
PENSACOLA FL 32559-5000

NAVAL RESERVE RETIREMENT CREDIT

If you are a member of the Naval Reserve, you may earn retirement points for successfully completing this course, if authorized under current directives governing retirement of Naval Reserve personnel. For Naval Reserve retirement, this course is evaluated at 6 points. (Refer to *Administrative Procedures for Naval Reservists on Inactive Duty*, BUPERSINST 1001.39, for more information about retirement points.)

Student Comments

Course Title: Seaman

NAVEDTRA: 14067 **Date:** _____

We need some information about you:

Rate/Rank and Name: _____ SSN: _____ Command/Unit _____

Street Address: _____ City: _____ State/FPO: _____ Zip _____

Your comments, suggestions, etc.:

<p>Privacy Act Statement: Under authority of Title 5, USC 301, information regarding your military status is requested in processing your comments and in preparing a reply. This information will not be divulged without written authorization to anyone other than those within DOD for official use in determining performance.</p>
--

NETPDTC 1550/41 (Rev 4-00)

CHAPTER 1

WATCHES

As a Seaman, you are a part of the backbone of the Navy. Depending upon the location of your duty station, you may be assigned to do anything from clerical work to helping run a ship. Since most Seamen have duty assignments on board ships, this course will deal basically with that situation.

On board a ship, you will be assigned to jobs such as keeping up the ship's compartments, decks, deck machinery and other equipment, external structures, and lines and rigging. You will also be standing deck watches, such as helmsman, lookout, and messenger watches underway and in port; standing sentry, fire, security, anchor and other special watches; manning and operating small boats, booms, cranes and winches; and acting as a member of gun crews and damage control parties. Without personnel with the skills to do these jobs, the power of the Navy would be nonexistent. We will talk about watch standing in this chapter.

A Navy ship in commission can never be left unattended. In port or underway, the security of the ship and the safety of personnel are vital. As an underway watch stander, you have, by necessity, a great responsibility placed upon your shoulders. Outstanding performance is the only acceptable performance, and it is also the minimum standard.

WATCHES

LEARNING OBJECTIVE: Identify the different types of watches aboard ship.

When assigned to a watch, you are responsible for the proper performance of all the duties prescribed for that watch. You should remain alert, be prepared for any emergency, and require all subordinates to be attentive. Orders must be issued in the customary style of the U.S. Navy.

When you are on watch, it is your duty to promptly inform the officer of the deck (OOD), the Boatswain's Mate, or the petty officer of the watch of any matters about the watch. Do not relieve another watch stander until you are thoroughly acquainted with the standards and responsibilities pertaining to the watch. You may decline to relieve your predecessor if you feel it is

justified, but you must immediately report that action to the officer of the deck (OOD).

Finally, as a watch stander, do not leave your post until relieved or secured by proper authority. Clearly, the highest level of professional performance is expected when on watch.

TYPES OF WATCHES

Civilian companies that work around the clock are said to have shifts. In the Navy, the ship's day is divided into watches. These watches follow one another continuously, and not only keep the ship in operation but also keep it ready for possible action.

The term watch is used in several ways. Most of the watches are of 4 hours' duration. Usually, it means one of the periods into which the day is divided, as in the following watch periods.

- 0000-0400 MIDWATCH
- 0400-0800 MORNING WATCH
- 0800-1200 FORENOON WATCH
- 1200-1600 AFTERNOON WATCH
- 1600-1800 FIRST DOG WATCH
- 1800-2000 SECOND DOG WATCH
- 2000-2400 EVENING WATCH

The 1600 to 2000 watch is dogged, which means it is divided to allow personnel to be relieved to eat their evening meal. The dog watches also permit rotation of the watches. Otherwise, personnel would stand the same watch each day. (Usually, the 1600 to 2000 watch is dogged only at sea.)

DUTIES OF A WATCH STANDER

A watch, in-port or underway, sometimes refers to the location of the member on watch, such as the quarterdeck watch. It may also refer to the section of the ship's crew on duty or to a member on watch, such as the lookout watch.

Each member of the crew is assigned to a watch section. The number of sections varies with the number of personnel assigned and the ship's commitment. When word is passed that the first section (or the second, and so on) has the watch, each member in that section reports to his or her assigned watch station.

Watches must be relieved in ample time. Usually, this means 30 minutes before the next watch. This time difference is essential so the relief can receive information and/or instructions from the person on watch. In the case of night lookouts, this extra time allows your eyes to adjust to night vision.

When reporting directly to the person being relieved, a relief should say, "I AM READY TO RELIEVE YOU." The person to be relieved then passes on to the relief any pertinent instructions or information relating to the proper standing of the watch. When the conditions and instructions are understood by the oncoming watch, he or she reports to the OOD, saying "I REQUEST TO ASSUME THE DUTIES OF (MESSENGER, PETTY OFFICER OF THE WATCH, ETC.)." The OOD may question the relief as to the instructions, and once satisfied, will grant permission. The offgoing watch then reports to the OOD that he or she has been properly relieved.

CONDITIONS OF READINESS

LEARNING OBJECTIVES: Identify the conditions of readiness aboard ship. Explain the duties of the messenger, including general rules and the handling of incoming messages.

Six conditions of readiness govern the type of watch aboard ship. Following is a brief description of these conditions of readiness.

	GENERAL DEGREES OF READINESS	CONDITION WATCH
1st	Complete readiness for immediate action	I
2nd	Temporary relaxation from 1st degree for rest and for meals at battle stations	IE
2nd	Readiness to conduct amphibious assault operations	IA
2nd	Readiness to conduct ASW operations	IAS
Special	Readiness for limited action	
3rd	Part of armament ready for immediate action, remainder on short notice	II
3rd	Readiness to conduct ASW operations for prolonged periods with all sensors and control stations and some weapons manned	IIAS

	GENERAL DEGREES OF READINESS	CONDITION WATCH
4th	Part of armament ready for immediate action, remainder at prolonged notice	III
5th	Peacetime cruising, no armament manned	IV
6th	In port, peacetime, no armament manned	V

DUTIES OF A MESSENGER

Most messenger duties are as messenger to the officer of the deck, commonly called the OOD messenger.

When given a message to deliver, be sure you know exactly where to go and what to say. When you arrive at your destination, repeat the message in the exact words that were told to you. Always carry the messages directly and quickly.

Before returning to the sender to report delivery of the message, wait for a reply or until you are told there is none.

MESSAGES

Messages for the captain of the ship or the admiral should be delivered to the respective officer or to his or her orderly if one is assigned.

Develop resourcefulness in tracking down people who are not easy to locate. Report your return to the officer of the deck; and if there was a delay in delivering the message, tell him why.

GENERAL RULES FOR A MESSENGER

The general rules for a messenger are as follows:

1. Be in the prescribed uniform of the day at all times.
2. Be attentive to all calls.
3. Deliver messages directly and quickly. Return at once to the sender and report the delivery of the message.
4. If unable to deliver a message, report this fact at once to the sender.
5. If you are sent to an officer's or chief petty officer's room, knock. Do not enter until you are told to do so.
6. Before going to meals or to the head, obtain permission from the petty officer of the watch.

7. Unseamanlike conduct, skylarking, or other such behavior is never permitted.

8. Remain covered in officer country. Salute the officer to whom a message is addressed.

9. Uncover before entering the wardroom or chiefs mess unless you are on watch and wearing the duty belt.

10. Uncover if you enter any area where a meal is in process, even if you are wearing the duty belt.

IN-PORT WATCHES

LEARNING OBJECTIVE: Explain the in-port watches that are required for a messenger:

Underway, your station as messenger of the watch is located on the bridge; in port, it is located on the quarterdeck. Besides keeping the quarterdeck swept down and neat, lend a hand whenever you are needed. If you have the morning watch, clean the entire quarterdeck area and polish all the brightwork.

At home, ashore, and at sea, the telephone is a part of everyone's life. It is an essential instrument in every Navy office and you must know how to use it properly. By observing proper techniques, you will be able to give and receive information correctly and quickly. Remember that the success of your telephone conversations depends almost entirely upon your ability to express yourself in words, whereas when you are speaking to a person directly, your facial expressions, gestures, and the like, all aid in getting your point across.

OFFICE TELEPHONE WATCH

Good telephone technique starts with answering your telephone quickly. Don't let it ring several times while you finish what you are doing. After lifting the receiver, speak immediately to the person calling; identify your command, yourself, and your position; inform the person calling that the line is an unsecure line. Usually the person making the call will do the same. This procedure puts the conversation on a businesslike basis and eliminates uncertainty as to who is on the other end.

Do not go on talking to someone in the office when you answer the telephone. You never know who your caller may be, and information heard this way could be harmful to national security. Also, it is discourteous to

make the caller wait while you finish your office conversation.

When you answer the phone for someone who is absent from the office, give some facts to the person making the call. Do not merely say, "He's not in right now." Rather, tell the caller when you expect the person to return, or volunteer to help if you can. If you have no information concerning the whereabouts of the person called, ask if you may take a message.

Always make sure you have a pencil and pad beside the telephone for taking messages. This practice eliminates needless rummaging about while the other person is holding the line open. Also, it is worth remembering that the message will mean little to the person for whom it is intended unless you leave the following information: (1) name of the caller, (2) the message, (3) time of the message, and (4) your name.

SIDE BOYS

As a side boy, you stand your watch from 0800 to sunset except at mealtime and during general drills. Wear a clean dress uniform of the day at all times and be especially neat and military in appearance. Keep close to the quarterdeck at all times so you can hear the side boy's call on the boatswain's pipe.

When officers or civilian officials who rate side boys are coming aboard, the Boatswain's Mate sounds one veer on the pipe for two side boys, two veers for four, three veers for six, or four veers for eight. The number of veers depends on how many side boys the visitor rates.

At the sound of the pipe, all side boys indicated fall in smartly on the double in two ranks, facing each other to form a passageway at the gangway, and wait at attention. The Boatswain's Mate then sounds the call "Alongside" so as to finish just as the visitor's boat makes the gangway. During this pipe, the side boys remain at attention but do not salute.

The Boatswain's Mate then falls in to the rear of the rank of side boys and starts the call "Over the side" as the visitor's head appears at the quarterdeck level. At the first note of this call, you and the other side boys salute smartly in unison. The salute is dropped at the last note of the call.

When visitors are leaving, the side boys are again called by the boatswain's pipe. This time, however, the Boatswain's Mate immediately falls in with you and first sounds "Over the side" as the visitor passes toward the gangway. You and the other side boys salute on the

first note and drop the salute on the last note. Remain at attention while the pipe again sounds "Alongside" as the boat departs. Do not break ranks from the gangway until you are released by the Boatswain's Mate. Never leave the vicinity of the quarterdeck without permission of the Boatswain's Mate.

During these side honors, you may have the opportunity to see important people. Your close range, however, does not give you permission to stare at them as they pass. Your eyes must always be kept straight ahead.

PIER SENTRIES

When required, the pier sentries will be posted at the head of the pier. They will perform duties as directed by the OOD (in port), including security of the pier and acting in ceremonial duties.

SECURITY WATCHES

Additional security watches and patrols may be assigned at the discretion of the Commanding Officer to increase physical security. Accordingly, watch personnel must keep the Commanding Officer informed through at least hourly reports to the OOD (in port). Personnel assigned to security watches and patrols will be qualified by the Security Officer, if assigned, or the department head responsible for specific watch and patrol areas. Duties of security watches and patrols include, but are not limited to, the following:

- Maintaining continuous patrols above and below decks
- Checking classified stowage, including spaces containing classified equipment
- Being alert for evidence of sabotage, theft, and hazards
- Checking security of weapons magazines
- Periodically inspecting damage control closures
- Checking the disbursing office and other spaces containing public funds
- Checking the ship's store outlets and storerooms

ANCHOR WATCH

The anchor watch is stationed as required by the commanding officer. The watch is instructed by the

ship's boatswain, and watch duties are performed under the direction of the OOD. The watch, posted in the immediate vicinity of the ground tackle, maintains a continuous watch on the anchor chain to observe the strain and how the chain is tending. You should familiarize yourself with the different strains (light, light to moderate, and moderate to heavy strain).

When an anchor watch is posted, a drift lead is often in use. This is a weight dropped to the bottom, attached to a line that should be kept slack. When the bridge asks "HOW DOES THE DRIFT LEAD TEND?", you should take up enough slack in the line to see which direction the lead is from the bow. As the ship veers around the anchor, the lead will tend to starboard or port, or underfoot. It may tend slightly aft as the ship surges. If there is no slack in the line and it tends noticeably forward, the anchor is probably dragging, and the bridge needs to know.

SHIPBOARD UNDERWAY WATCHES

LEARNING OBJECTIVE: Describe the duties of the underway bridge team members.

The personnel assigned to watch-standing duties are entrusted with the safety and proper operation of the ship. In many instances, watch standers who have failed to understand their responsibilities and authority have caused a collision, grounding, and even the loss of a ship. On the other hand, there are many cases of record where serious damage and loss of life were averted by the timely action of watch standers working as a coordinated and integrated team.

OFFICER OF THE DECK (OOD) UNDERWAY

The officer of the deck (OOD) underway has been designated by the Commanding Officer to be in charge of the ship, including its safe and proper operation. The OOD reports directly to the Commanding Officer for the safe navigation and general operation of the ship; to the Executive Officer for carrying out the ship's routine; and to the Navigator on sighting navigational landmarks, and on course and speed changes.

JUNIOR OFFICER OF THE DECK (JOOD)/CONNING OFFICER

The JOOD/CONNING OFFICER is the principal assistant to the OOD. Anyone making routine reports to the OOD normally makes them through the Conning

Officer. The Conning Officer stands the watch in the pilot house, but may be stationed on the open bridge during complex tactical operations or when directed by the OOD for indoctrinational purposes.

BOATSWAIN'S MATE OF THE WATCH

The Boatswain's Mate of the watch (BMOW) stands watch on the bridge when underway. His or her primary duty is to assist the OOD in carrying out the ship's routine and ensuring the efficient functioning of the watch team. It is the responsibility of the BMOW to see that all deck watch stations are manned, that all watch standers in previous watch sections are relieved, and that the oncoming enlisted watch team is in the prescribed watch-standing uniform. The BMOW will also assist the OOD in supervising and instructing members of the watch in their duties.

QUARTERMASTER OF THE WATCH

The Quartermaster of the watch (QMOW) is stationed on the bridge, and reports to the OOD all changes of weather, and temperature and barometer readings. He or she must be a qualified helmsman, and assist the OOD in navigational matters. The QMOW is responsible for entering in the Ship's Log all data required by current instructions or as directed by the OOD, and for executing sunset and sunrise procedures.

HELMSMAN

The helmsman must have successfully completed all personnel qualification standards for helmsmen and be qualified by the navigator. The courses the helmsman steers must be ordered by the conning officer.

The ability to steer can be attained only by practice. The first fact to bear in mind is that the ship turns under the compass card; the compass card itself remains steady. Thus, when the card appears to be turning to the left of the lubber's line, it really is the line (the ship's head) that is moving to the right. On all modern ships, the wheel, rudder, and ship's head all move in the same direction. To move the lubber's line and ship's head back to the left, then, you must turn the wheel to the left.

As a new helmsman, you may use too much rudder. This forcefulness is a natural trait, since when you turn your auto steering wheel, your car immediately turns; yet when you turn the ship's wheel a few degrees, nothing happens, because time is required for the

steering engine to operate and for the ship to begin answering its rudder.

When a ship is conned through a passage, such as the Panama Canal, or up to a berth or anchorage, the helmsman frequently is ordered to steer on a range, landmark, light, or some other object, instead of by the compass. Many helmsmen are so accustomed to the compass that they become tense under these circumstances. The simple truth is that it is always much easier to hold a ship steady on some object ahead than to keep on course by compass. Usually, the compass is located well abaft the bow, and the ship's head can swing quite a bit before the movement registers on the card. However, when the bow or the forestay is lined up with a mark ahead, the helmsman can see the ship go off course the instant it starts to do so.

Have the ship steady on course before you surrender the wheel to your relief. Inform your relief of the course and the compass or repeater you are steering by. If it is a gyro repeater, be sure you designate the correct repeater (if more than one). Also inform your relief of the equivalent course to steer by magnetic compass if the gyro fails and, if you are zigzagging, both the immediate course the ship is on and the base course it will follow when it ceases to zigzag.

Tell your relief about any steering peculiarity you discovered, such as "Carrying a little right rudder," or "Carrying mostly left." Relay any order you received that still is standing, such as "NOTHING TO THE LEFT," or "STEADY ON COURSE 091." If you are steering on a ship, range, landmark, or light, point it out to your relief, making sure it is recognized.

Good steering gets the ship to its destination faster by making mileage in the desired direction and by cutting down the drag caused by use of the rudder. It also enhances the reputation of the ship, lessens the possibility of a steering casualty, and is important to the safety of the ship. Every Seaman should, therefore, make the most of every opportunity to learn to steer. When on the helm, a Seaman should give exclusive attention to steering, regardless of previous experience.

Orders to the Helmsman

The words port and starboard are never used when giving orders to the helmsman. Years ago, right and left were substituted because they are more distinct. When an order necessitates a change of rudder angle to right or left, the direction of change is always stated first, such as "RIGHT FULL RUDDER." Standard orders to

the helmsman and their corresponding meaning are as follows:

RIGHT (LEFT) FULL RUDDER usually means 30 degrees on the rudder angle indicator.

HARD RIGHT (LEFT) RUDDER means put the rudder over to the right the maximum degrees allowed by that class of ship.

RIGHT (LEFT) STANDARD RUDDER varies on different ship classes. It is the designated number of degrees of rudder angle that causes the ships of that class to turn within a prescribed distance, called the ship's standard tactical diameter. You must find out what standard rudder is on your ship.

COME RIGHT (LEFT) TO 148 means to swing the ship's head in the direction stated and steady it on the course given; in this example, 148 degrees.

STEER 190 is the order usually given for only a minor change of heading to the number of degrees specified.

STEADY ON 225 states the course on which the ship's head is to be steadied. It normally is given while swinging.

INCREASE YOUR RUDDER means to increase the rudder angle; it is usually ordered when the conning officer wants the ship to move more rapidly.

EASE YOUR RUDDER means to reduce the rudder angle. It may be given as "EASE TO 15 DEGREES (10 DEGREES, 20 DEGREES) RUDDER."

RUDDER AMIDSHIPS means to put the rudder on the centerline; no rudder angle. As a rule, this order is merely, "MIDSHIPS!"

MEET HER means to check but not stop the swing by putting on opposite rudder. This order may be given when the ship is nearing the desired course.

STEADY means to steady the ship on the course it is heading at the time the order is given. If the ship is swinging at the time, the heading must be noted and the lubber's line brought back to and steadied on it as soon as possible. The order is also stated "STEADY AS YOU GO," and "STEADY AS SHE GOES."

SHIFT YOUR RUDDER commands you to change to the same number of degrees of opposite rudder angle. In other words, if your rudder angle is 15 degrees right and the order is given, you change to 15 degrees left rudder. This order is given most often when a single-screw ship loses headway and begins to gather

stemway, so as to partially counteract its tendency to back to port.

MIND YOUR HELM! is a warning that the ship is swinging off the course because of bad steering.

NOTHING TO THE RIGHT (LEFT) is given when the presence of some danger on one side or the other makes it necessary to avoid a set in that direction. You must keep the ship from swinging past the course in the direction warned against.

HOW IS YOUR RUDDER? is a question to the helmsman. The helmsman should reply, "5 (10, 15, etc.) DEGREES RIGHT (LEFT), SIR" or "FULL (STANDARD) RIGHT (LEFT) RUDDER, SIR."

HOW DOES SHE HEAD? or *MARK YOUR HEAD?* is a question to the helmsman. The helmsman should give the ship's head at the time, for example, "TWO SEVEN FIVE, SIR."

KEEP HER SO means to continue to steer the course you are heading. This order is usually given after you state the course you are steering.

VERY WELL is a reply of the conning officer to the helmsman, meaning that the situation is understood.

You must repeat distinctly, word for word, every order you receive so the officer of the deck or pilot may know that you understood correctly. Also report when you have carried out an order; for instance, report immediately when the rudder is right full or the ship is steady on 257 degrees. Also, when you are making a swing, report occasionally the compass heading that the lubber's line is passing so the conning officer can tell how far the ship has gone through the swing. Thus, if ordered to take the ship right from 000 degrees to 045 degrees, do not wait until you are heading 045 degrees to report. As the ship's head goes through the swing, report about every 10 degrees: 'PASSING 010, SIR,' for example.

NOTE

Before becoming a qualified helmsman, you should be given a written test of the orders and have at least 30 to 50 hours logged.

Lee Helmsman

The lee helmsman, as a qualified standby, regularly relieves the helmsman. The lee helmsman stands watch at the engine order telegraph. In this capacity the lee helmsman rings up the conning officer's orders to the

engine room, assuring and informing the conning officer that all bells are answered properly.

Although *port* and *starboard* are never used in orders to the helmsman, they are used when giving orders to the operator of the engine order telegraph. Stated first is the engine affected, then the direction in which the handle is to be moved, followed by the speed desired; for example, "PORT ENGINE AHEAD TWO-THIRDS," "ALL ENGINES STOP," and "PORT ENGINE BACK ONE-THIRD." Note that *all* is specified instead of *both*, because *both* could sound like *port*. *Back* is specified instead of *astern*, to avoid the confusion of *astern* with *ahead*.

To make sure you have heard your order correctly, repeat it aloud distinctly before you operate; thus, "STARBOARD ENGINE AHEAD TWO-THIRDS, SIR." When the answer appears on the pointer from below, sing it out: "STARBOARD ENGINE ANSWERS AHEAD TWO-THIRDS, SIR." The conning officer may order a specific rpm, for example; your reply then would be "ALL ENGINES AHEAD FLANK, 121 RPM INDICATED AND ANSWERED FOR, SIR!"

FOG WATCH

The fog watch is stationed in fog or reduced visibility. The watch is stood in those locations where approaching ships can best be seen or heard. Usually it is stood on the forecastle all the way forward, at a place commonly called the eyes of the ship. It is the duty of the fog lookouts to stand an alert watch to detect by either hearing fog signals or actually sighting approaching ships or craft or channel buoys. The fog lookout must be in direct communication with the OOD and is normally assisted by a phone talker because the fog lookout's heading must not be impaired by the wearing of sound-powered telephones.

LIFEBOAT WATCH

The ready lifeboat is likely to be a motor whaleboat, gripped in a strongback between the davits and ready for lowering. Usually one boat on either side is prepared in this manner. The leeward boat is the one you will use if you have to lower away.

Although lifeboat watches are not necessarily required to be on station at the lifeboat, crews should always be designated when at sea and be mustered as required. The Boatswain's Mate of the watch or the boat coxswain will tell you what your duties are—whether manning the boat, lowering, clearing falls, or so on. If

you are not told, ask! Handling the lifeboat is important, often dangerous work demanding expert knowledge on the part of every member.

LOOKOUT AND SOUND-POWERED-TELEPHONE TALKER WATCHES

Lookout duties are discussed in *Basic Military Requirements*, NAVEDTRA 10054-F. Telephone talker procedures also are covered in it and in the *Sound-Powered Telephone Talkers' Manual*, NAVEDTRA 14005-A. Another text covering lookout duties is the *Lookout Training Handbook*, NAVEDTRA 12968.

Sky and surface lookouts man the appropriate lookout stations and perform duties according to the ship's lookout doctrine. Lookouts are relieved at least hourly. They are under the direct supervision of the OOD, but are trained in their duties by the CIC officer. The *Navigation Rules, International Inland* requires that every vessel maintain a proper lookout by sight and hearing at all times.

The life buoy/after lookout watch is located at the designated station aft. If assigned, you will have a life ring with distress marker light attached and at least two pyrotechnic smoke floats in your possession, and will maintain an alert watch for persons overboard. Also, you will man sound-powered phones and will check communication with the bridge at least every half hour. During conditions of low visibility, this watch will be augmented by another person who will be the phone talker.

If assigned as bridge sound-powered-telephone talker, you will man either the JV or JL/JS circuits. The JV talker must be familiar with all other stations on the circuit and relay all orders from the OOD to these stations, including paralleling all orders to the engine order telegraph. Also, the talker relays all information from these stations to the OOD.

The JL/JS talker must be familiar with all other stations on the circuit and relay all orders from the OOD to these stations. The talker keeps the OOD informed of all information coming over the circuit.

TIME

LEARNING OBJECTIVES: Explain how time is computed in the Navy, the different kinds of times zones, and how to convert Greenwich mean time to local time, and local time to Greenwich mean time.

For time computations, the surface of Earth is divided into 24 zones, each consisting of 15 degrees.

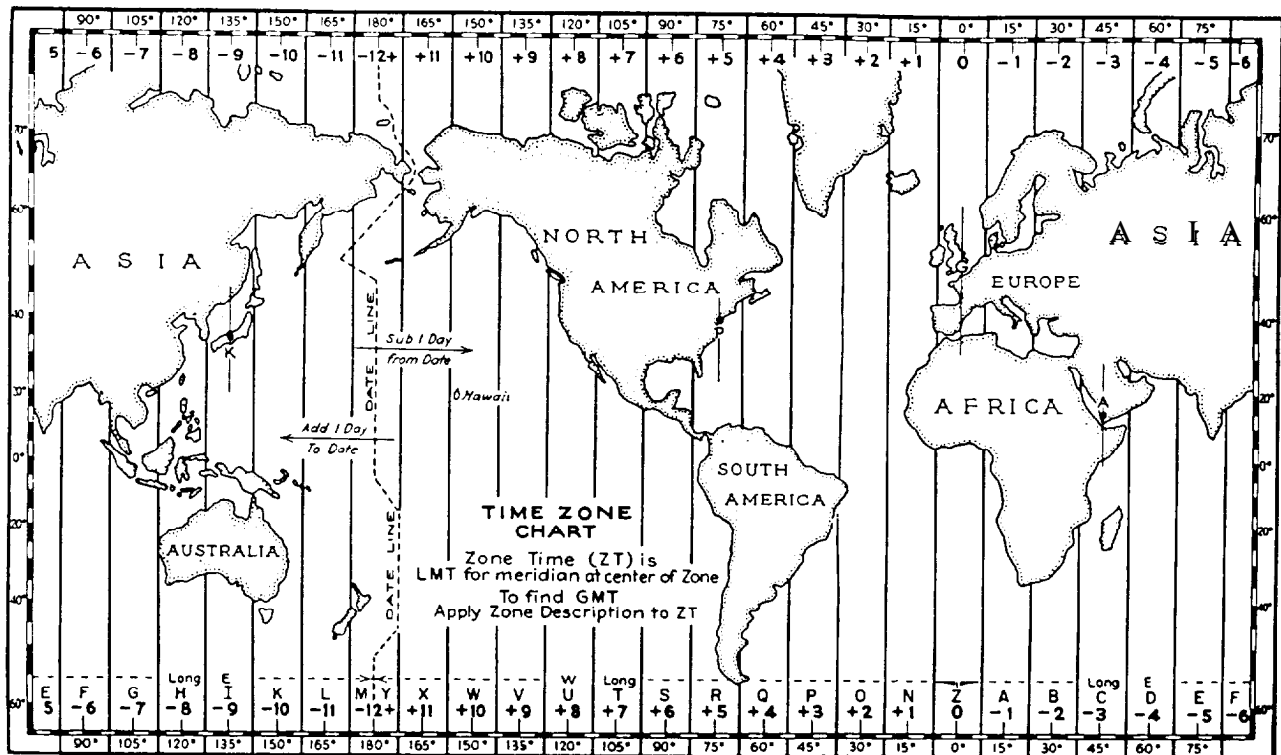

Figure 1-1.—Time zone chart of the world.

Each time zone is different by 1 hour from each of the zones next to it. See figure 1-1.

The initial time zone is called zero and extends 7 1/2 degrees either side of the zero meridian. The time of this zone is known as Greenwich mean time (GMT), often referred to as Zulu time. Each zone, in turn, is represented by the number that indicates the difference between the local zone time and GMT.

ZERO DEGREES LINE

Zones lying in longitudes east of zone zero are numbered from 1 to 12. They are designated minus because the zone number must be subtracted from local time to obtain GMT. Zones lying in longitudes west of zone zero also are numbered from 1 to 12 but are designated plus, because the zone number must be added to local zone time to obtain GMT.

Besides its zone number, each zone is assigned a letter. Zones A through M (J is omitted) are minus zones; zones N through Y are plus zones. The number of a zone, preceded by a plus or minus sign, is the zone description.

PRIME MERIDIAN

The 12th zone is divided by the 180th meridian, the minus half lying in east longitude and the plus half in west longitude. This meridian is the international date line, where each worldwide day begins and ends. If a ship crosses going to the west, the date is advanced one day. If a ship crosses the line going to the east, the date becomes one day earlier.

GREENWICH MEANTIME

Greenwich mean time (GMT) was adopted so that time may be uniform throughout the military services. This uniformity eliminates any doubt about which time is used. The designating letter for GMT is Z. (In lettering or printing, a horizontal bar through the riser of the capital letter Z helps prevent its being mistaken for the numeral 2.)

In the 24-hour system, the approved method of representing time is with the hours and minutes expressed as a four-digit group. The first two numbers of the group denote the hour, and the second two, the minutes. Thus, 6:30 a.m. becomes 0630; noon is 1200; 6:30 p.m. is 1830. Midnight is expressed as 0000 or 2400, and 1 minute past midnight becomes 0001. The time designation 1327Z shows that it is 27 minutes past

1:00 p.m. GMT. Numbers indicating the day of the month are placed before the time of the day to form what is known as a date-time group (DTG). The DTG 171320Z means the 17th day of the current month plus the time in GMT. Dates from the 1st of the month to the 9th of the month are preceded by the numeral 0. (For example, 041327Z is the 4th day of the month.)

Applying the preceding facts, you easily can figure GMT from your local zone time. Assume that you are on a ship operating in the Virginia Capes area where the local zone time is 1700R. The R time zone has a number designation of +5, which indicates the R time zone is 5 hours behind GMT. Simply add 5 hours to your present time of 1700, to find that it is 2200 GMT.

The reverse is true when computing GMT if you are in a time zone that lies in the eastern longitude. Assume your ship is in the Eastern Mediterranean and the time is 0900B. Zone B has a numeral designation of -2, so you simply subtract 2 hours from 0900 to find that GMT is 0700.

SUMMARY

In this chapter, you learned about shipboard watches, in-port and underway. You learned about the conditions of readiness and how to convert time. It is now up to you to put what you learned into use.

CHAPTER 2

WATCHSTANDERS' EQUIPMENT

Whether you are a Seaman or an officer aboard a ship, you will be assigned certain duty periods. Watchstanding is a necessary and an important part of Navy life. And the equipment used in watchstanding helps to keep the Navy operating efficiently.

The following instruments or apparatus are found on the bridge:

- steering
- sounding
- indicating ship's heading and rudder angle
- measuring speed
- communicating speed orders to the engine room
- taking bearings and ranges
- controlling running lights and speed lights
- indicating revolutions made by the engines, and communicating with other departments in the ship and with other ships

COMPASSES

LEARNING OBJECTIVE: Explain the operation of the gyrocompass and the magnetic compass.

A compass is an instrument that tells you the direction you are heading. It also tells you where north is so you can measure all other directions from that one fixed point or direction.

There are two main types of compasses. They are gyrocompasses and magnetic compasses. The gyrocompass works on the gyro principle of a spinning wheel. The magnetic compass is affected by Earth's magnetic field. In each instance the objective is to produce a compass card (fig. 2-1) that points toward the north. From the compass card, the directions can be taken in degrees or in terms such as north, south, southwest. The Navy expresses direction in degrees, saying the direction or course is 000°, 180° or 225°, instead of north, south, or southwest.

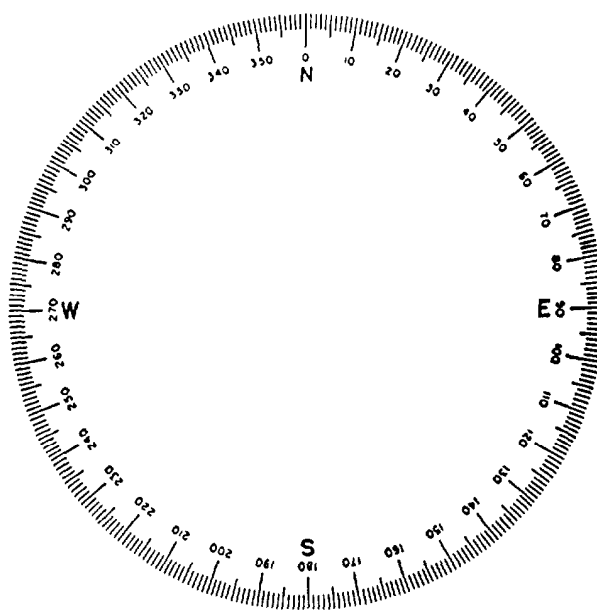

Figure 2-1.— Compass card.

GYROCOMPASS

The gyrocompass is unaffected by magnetic influence. When in proper running order, the gyrocompass points constantly to true north, rather than magnetic north. It may have a slight mechanical error of 1° or 2°, but the error is computed easily and remains constant for any heading; the error does not interfere in any way with the instrument's practical value.

A typical shipboard installation consists of master gyros whose indications are sent electrically to repeaters located at the conning stations, on the bridge wings, and at other necessary points. One advantage of the gyro is that its repeaters may be set up at any angle—nearly vertical for the convenience of helmsmen, or horizontal for taking bearings.

Despite the excellence of the gyro mechanism, the magnetic compass is still standard equipment used aboard ship. Because the gyrocompass is powered by electricity, it would be useless in a power failure. It is an extremely complicated and delicate instrument, and it is subject to mechanical failure. For instance, some gyros become erratic after the ship makes a series of sharp turns at high speed. This does not mean, however, that great confidence cannot be placed in the gyro. When the gyro is running properly, it can be depended upon to

point faithfully and steadily to true north. But the magnetic compass remains the reliable standby, constantly checking the gyro's performance, and ready always to take over if it fails.

MAGNETIC COMPASS

The magnetic compass operates through the attraction exerted by Earth itself. Because Earth is certain to continue to function as a magnet, the magnetic compass has an unfailing power source.

The magnetic compass (fig. 2-2) is located in the pilothouse. It consists of a magnetized compass needle attached to a circular compass card, usually 7 1/2 inches in diameter. The card and the needle are supported on a pivot that is set in a cast bronze bowl filled with a petroleum distillate fluid similar to Varsol. This liquid buoys up the card and the magnet. The buoyancy will take some of the load off the pivot, thereby reducing the friction and letting the card turn more easily on the pivot. At the same time, the liquid slows the swing of the card and brings it to rest more quickly. Marked on the compass bowl is a line, called the lubber's line, which agrees with the fore-and-aft line of the ship or boat. By reading the compass card's direction lined up with the lubber's line, you can tell the direction the ship is heading.

The card remains stationary, pointing at the magnetic pole which is a north-south line lined up with the north-south (magnetic) directions on Earth. When you are steering, always remember that the ship turns under the card.

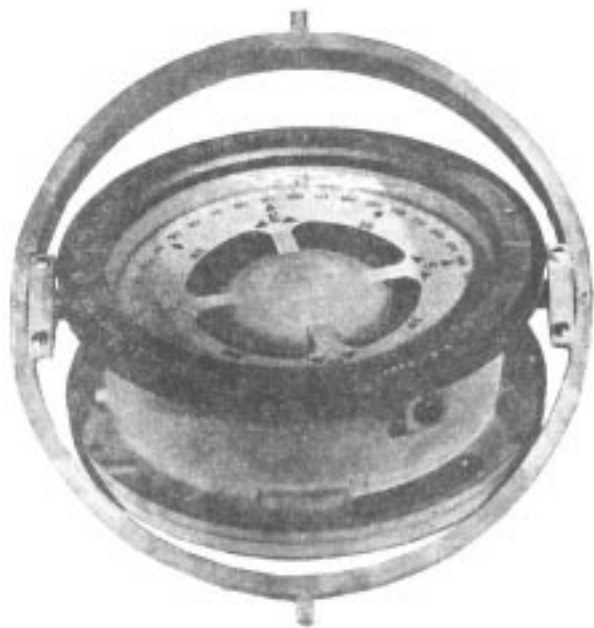

Figure 2-2.— Navy standard 7 1/2-Inch compass.

The compass bowl is mounted in a system of double rings on bearings, known as gimbals, permitting the compass card to ride flat and steady no matter how the ship may roll. In turn, the gimbal rings are mounted in a stand called the binnacle (fig. 2-3). The Navy uses a compensating binnacle, on which two spheres of soft iron are mounted on arms, one on either side of the compass. The spheres are adjusted to counteract some of the deviation (covered later in this chapter). To correct for other local magnetic forces that make up the deviation, small magnets are located within the binnacle, directly below the compass. The binnacle is positioned forward of the wheel, where it can best be seen by the helmsman.

The compass card is divided into 360°, numbered all the way around in a clockwise direction.

A true course to be steered can be converted into a magnetic compass course by adding or subtracting variation for the area and deviation for the compass on

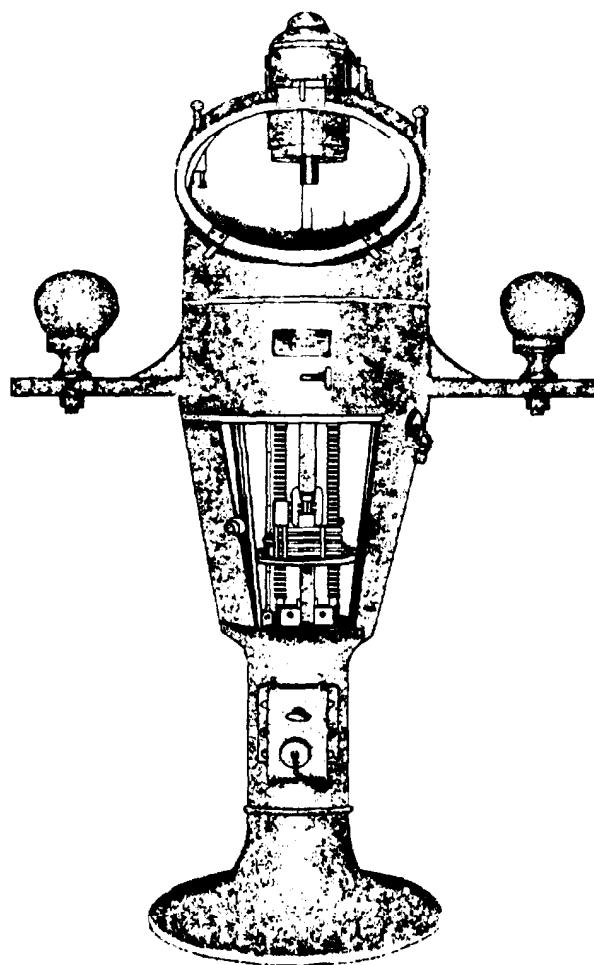

Figure 2-3.— Navy standard magnetic compass binnacle.

that heading. When converting true heading to magnetic, subtract easterly errors and add westerly errors.

CIRCULAR MEASUREMENT

Before we go any further, you must know how distances are measured along the circumference of a circle. Measurement along a meridian, a perfect circle, is expressed in degrees of arc. These degrees of arc may be transformed into linear measurement. The compass card is the best example of circular measurement in degrees of arc.

Whatever the size of the card, its circumference always contains 360°. Each degree contains 60 minutes ('), and each minute contains 60 seconds (").

MAGNETIC COMPASS ERROR

LEARNING OBJECTIVE: Explain magnetic compass error, including variations and deviations.

Most of the time the magnetic compass does not point directly north. Usually, there is a difference of several degrees. This difference, known as compass error, is made up of variation and deviation.

VARIATION

The true North Pole and the magnetic north pole are not located at the same spot. This variation causes a magnetic compass needle to point more or less away from true north. The amount the needle is offset is called variation because the amount varies at different points on Earth's surface. Even in the same locality variation usually does not remain constant, but increases or decreases at a certain known rate annually.

The variation for any given locality, together with the amount of annual increase or decrease, is shown on the compass rose of the chart for that particular locality. The compass rose shown in figure 2-4 indicates that in 1990 there was a 14°45' westerly variation in that area, increasing 1' annually.

To find the amount of variation in this locality in 1995, count the number of years since 1990 (in this case 5); multiply that by the amount of annual increase; (which here gives you 5 X 1', or 5'); add that to the variation in 1990 and you have a 1995 variation of 14°50' W.

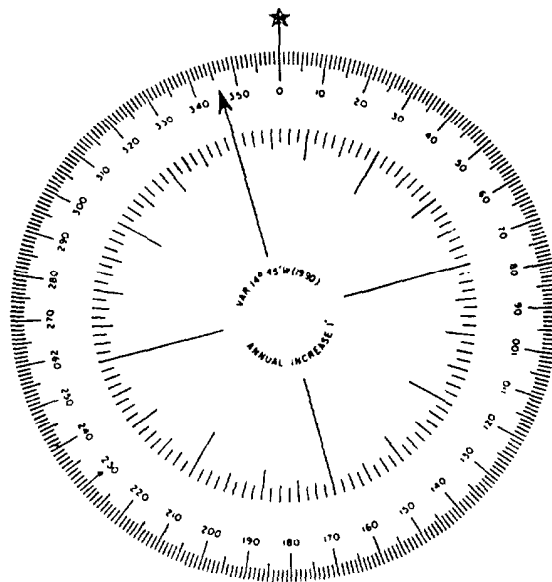

Figure 2-4— Compass rose.

Remember: If the annual variation is an increase, you add; if it is a decrease, you subtract.

Variation remains the same for any heading of the ship at a given locality. No matter which way the ship is heading, the magnetic compass, if affected only by variation, points steadily in the general direction of the magnetic north pole.

DEVIATION

The amount a magnetic compass needle is deflected by magnetic material in the ship is called deviation.

Although deviation remains a constant for any given compass heading, it is not the same on all headings. Deviation gradually increases, decreases, increases, and decreases again as the ship goes through an entire 360° of swing.

The magnetic steering compass is located in the pilothouse, where it is affected considerably by deviation. Usually the standard compass is topside, where the magnetic forces producing deviation are not as strong. Courses and bearings by these compasses must be carefully differentiated by the abbreviations psc (per standard compass), pstgc (per steering compass), and pgc (per gyrocompass). The standard compass provides a means for checking the steering compass and the gyrocompass.

Some ships may have another magnetic compass, also known as the emergency steering compass, located at the after steering station, when that station is topside.

GYROCOMPASS REPEATERS AND PELORUS

Gyro repeaters mounted on the bridge wings are located in stands somewhat similar to the binnacle. These instruments display directional information on the basis of electrical signals received from the ship's master gyrocompass.

Gyro repeaters on the bridge wings are used in taking bearings on objects outside the ship. Movable sighting vanes on the face of the gyro repeaters are aimed at the object in the same manner in which rifle sights are lined up. True bearings are read directly by observing the degree on the compass card with which the crossbar of the sighting vane lines up. Relative bearings may be read from an outer dumb compass ring on the repeater stand.

True bearing is the direction of an object from the observer, measured clockwise from true north.

Compass bearing is the direction of an object as indicated by the magnetic compass. It must be converted into true hearing by applying the corrections for variation and deviation.

Relative bearing is the direction of an object from the observer, measured clockwise from the ship's heading as indicated by the lubber's line in the binnacle

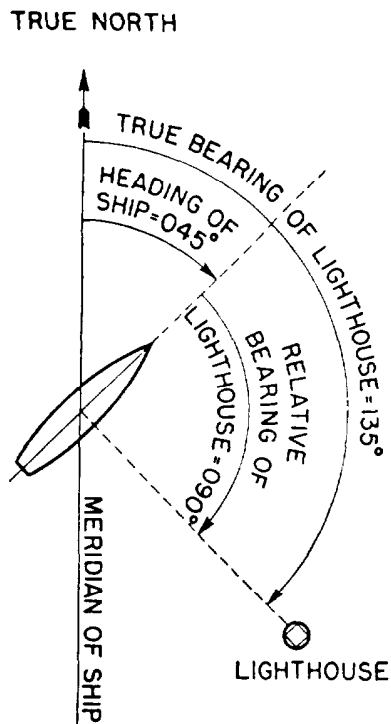

Figure 2-5.— True and relative bearings.

or the gyro repeater. When a bearing is recorded, it is assumed to be a true bearing unless it is followed by the capital letter R, which would mean that the bearing is relative. Figure 2-5 shows true and relative bearings of a lighthouse from a ship.

As you learned in *Basic Military Requirements*, lookouts report objects they see in relative bearings by degrees (usually to the nearest 10 degrees) based on the fore-and-aft line of the ship, starting with dead ahead as 000°, on the starboard beam as 090°, dead astern as 180°, on the port beam as 270°, and through to dead ahead as 000°. Another look at the compass card in figure 2-1 will show you the positions of the relative bearings (in 10-degree increments) normally used by lookouts.

Relative bearings by points of the compass are sometimes used in certain problems connected with fixing position in piloting. Each point of the compass is equivalent to 011 1/4°, for a total of 32 points, as opposed to the 36 relative reporting positions. Table 2-1 is included for familiarization purposes.

Without the need of your knowing exact terminology, positions go on thusly around the ship in the 1-2-3-4-3-2-1 pattern, punctuated by “dead astern” and “on the port beam” to “dead ahead.” The relative degree indications continue around the ship in 011 1/4° steps, terminating at 000°.

Table 2-1— Relative Bearings by Points and Degrees

COMPASS POINTS	DEGREES
Dead Ahead	000
1 point on starboard bow	011 1/4
2 points on starboard bow	022 1/2
3 points on starboard bow	033 3/4
4 points (broad) on starboard bow	045
3 points forward of starboard beam	056 1/4
2 points forward of starboard beam	067 1/2
1 point forward of starboard beam	078 3/4
On the starboard beam	090

The reciprocal of any bearing is its opposite, meaning that the point or degree is on the opposite side of the compass card from the bearing. For example, the reciprocal of 180° is 000°, and vice versa. When you obtain a bearing on some object, the bearing from the object to you is the reciprocal of the bearing from you to it.

To find the reciprocal of any bearing expressed in degrees, simply add 180° to the bearing. If the bearing is 050°, for instance, its reciprocal is 050° plus 180°, or 230°. If your bearing is greater than 180°, subtract 180° to find the reciprocal.

SHIP'S STEERING AND SPEED CONTROL EQUIPMENT

LEARNING OBJECTIVE: Identify and explain the operation and usage of the ship's steering and control equipment.

The ship's steering and speed control equipment includes many parts and types of equipment. The parts and types of equipment may change from one ship class to another, so in the following pages we will discuss the ones most commonly used in the Navy today.

STEERING ENGINES

When ships began using steam as a means of propulsion, many problems were created. Foremost was inadequate hand-powered steering gear. The rapid increase in the size and speed of steamships resulted in a correspondingly greater turning effort required at rudder stocks. Consequently, a natural sequence of events led to the introduction of steam-powered steering gear.

Today, there are two types of steering engines. They are electromechanical and electrohydraulic. Electromechanical steering gear is found on some small ships. Most vessels of recent design are equipped with the electrohydraulic mechanism. A brief discussion of the types of steering gear follows.

Electromechanical steering gear applies power to the rudder by means of electromotive machinery. Because electromechanical gear requires large motors and considerable maintenance, it has been replaced, to a great extent, by electrohydraulic gear.

Naval vessels are equipped with electrohydraulic steering gear. Most destroyers use the single-ram steering gear, shown in figure 2-6. Aircraft carriers and some other large ships use a double-ram system.

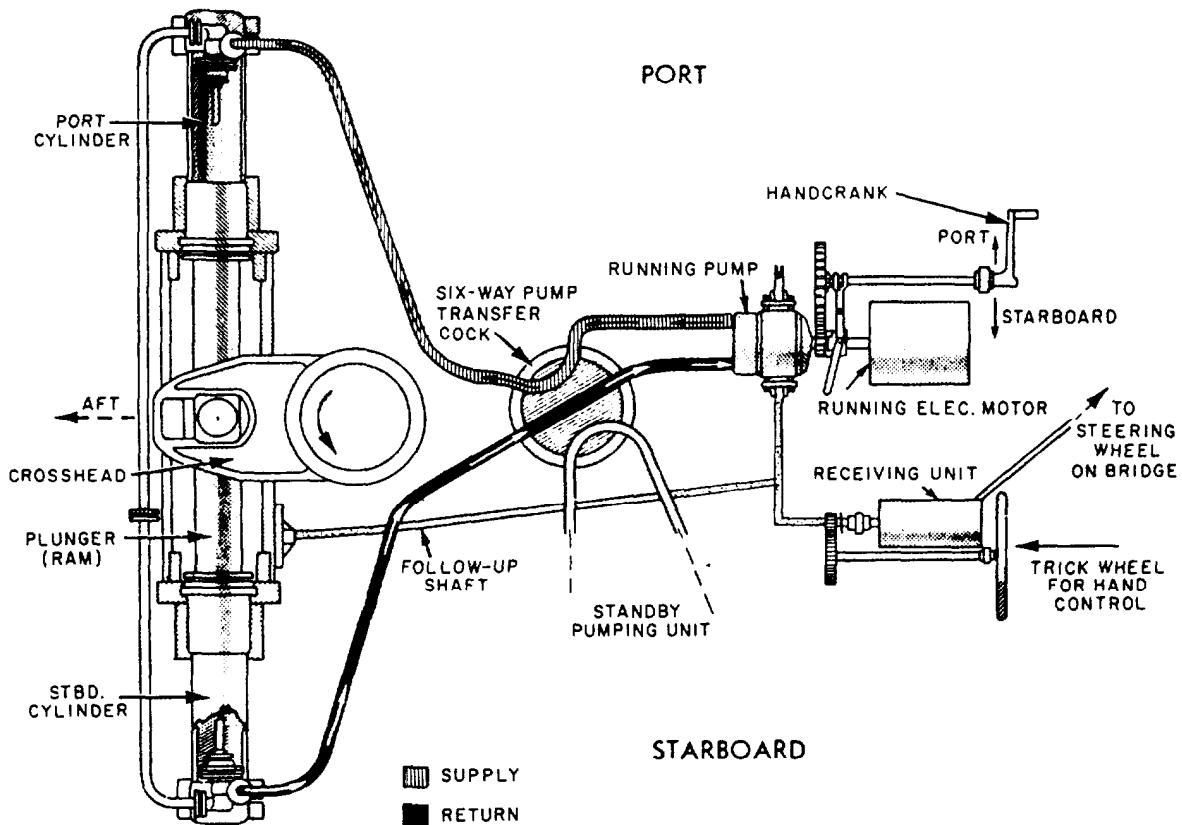

Figure 2-6— Single-ram electrohydraulic steering gear system.

For an idea of how the single-ram system works, refer to figure 2-6 and note what happens during a starboard turn. From the helm on the bridge, movement is transferred electrically to the receiving unit in after steering, where the electrical signal is converted to a mechanical signal. The receiving unit sends the mechanical signal to the running pump, and the pump proceeds to pump oil to the port cylinder. Oil, at the same time, is taken from the starboard cylinder by the pump's suction. As oil is pumped into the port cylinder, the ram is moved toward the starboard side, turning the rudder as it moves. The ram is forced toward the starboard side until the correct rudder position is obtained, at which time the follow-up shaft causes the pumping to cease.

Emergency Steering Gear

On ships equipped with electromechanical steering gear, the old-fashioned, hand-operated steering wheel is about the only recourse if the primary mechanism fails. On some small ships, a yoke can be fitted over the rudder head, and the rudder can be turned with a block and tackle.

Electrohydraulic steering gear usually is provided with a standby pumping unit for emergency use. It is composed of a pump and an electric motor, identical to those shown in figure 2-6. If the steering engine being employed has a casualty, the six-way pump transfer cock is adjusted to align the ram with the standby pumping unit; the power is turned on in the standby unit; and steering is transferred over to the standby unit.

Emergency steering for destroyers also uses the trick wheel, shown in figure 2-6. If a steering signal failure occurs between the steering wheel on the bridge and the receiving unit, the helmsman standing watch in after steering operates the trick wheel and receives steering orders on the sound-powered telephone. Should a power failure occur in steering aft, the rudder is moved by disengaging the running electric motor, and hand-pumping oil to the ram by means of a handcrank. This procedure is very slow. The rudder turns only a small amount for every revolution of the crank.

Steering Engine Cutout

A safety device is installed on every steering engine. This safety device stops rudder movement when the rudder is brought against the stops. The limit most rudders can be turned is 35° to either side of center. Full rudder on most ships is 30° right or left; the extra 5° is applied only in emergencies. Unless you are ordered to do so, never put the rudder hard over. It is possible for the rudder to jam against the stops, causing you to make circles in the ocean.

Rudder

Every ship is provided with a rudder located aft. When the rudder is set at an angle on a moving ship, a high-pressure area builds on the leading surface, and a low-pressure area forms on the trailing surface. Thus the water, through this difference in pressure areas, exerts a force against the leading surface of the rudder, which in turn forces the stem in the direction opposite that which the rudder is set.

When the helm on an oldtime ship was moved athwartships across the deck, the rudder motion was in the opposite direction. The result was that the ship's head would go in the direction opposite that in which the helm was moved, and this still is true of any small craft steered with a tiller. On all ships equipped with steering wheels, however, the wheel, rudder, and ship's head all move in the same direction. That is, when you turn the wheel to port, the rudder goes to port, and the ship makes its turn to port. Remember, though, that the ship begins its port turn by sending its stem to starboard.

The more headway a ship has, the more water piles up against the rudder under the counter, and the quicker the stem is pushed off. Consequently, a ship always turns faster and answers its rudder sooner at high speeds than at low speeds. Also, a greater angle on the rudder is required to turn a ship moving slow than one moving fast.

STEERING STATIONS

When a ship goes into action, no one knows where it might be hit. If a ship has only a single steering station, a hit there would put it out of the fight. For this reason, a combat ship has more than one steering station so that control can be shifted almost instantaneously to any station.

A destroyer, for instance, may be steered from the bridge, after steering, or the steering engine room. Some ships have fewer steering stations, but every ship has at least two.

RUDDER ANGLE INDICATOR

The instrument above and forward of the wheel angle indicator is the rudder angle order indicator-transmitter (fig. 2-7). This instrument has a dual purpose. During normal steering situations, it shows the actual angle of the rudder, which usually lags the wheel angle indicator by about 2° because of the time required for the steering mechanism to operate. For emergency steering, this instrument becomes useful in transmitting visual orders to the helmsman in after steering. By operation of the control knob, the rudder order is displayed on the instrument when the pointer

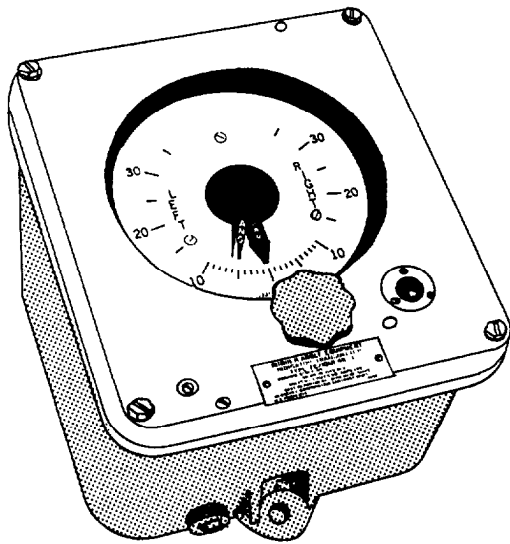

Figure 2-7.— Rudder angle order indicator-transmitter.

marked “ORD” is moved to the desired rudder angle. The order is displayed in after steering on another rudder angle order indicator-transmitter, from which the after helmsman receives orders. A push switch next to the rudder angle order indicator-transmitter on the bridge operates a bell in after steering to call the helmsman's attention to a change in rudder angle.

ENGINE ORDER TELEGRAPH

On the conning platform, an instrument called the engine order telegraph (fig. 2-8) communicates speed orders to the engine room. The engine order telegraph is circular, with duplicate dials divided into sectors for flank, full, standard, 2/3, and 1/3 speed ahead; 1/3, 2/3, and full speed back. A hand lever fitted with an indicator travels over the circumference of the circular face of the instrument. When the handle is moved to the required speed sector, the engine room complies with the order immediately and notifies the bridge by operating an answering pointer that follows into the same sector.

A ship with one engine has a telegraph with a single handle. Two-engine ships usually have a handle on the port side and another on the starboard side of the telegraph, controlling the engines on the corresponding sides. (The engine order telegraph shown in figure 2-8 is equipped with separate handles for port and starboard engines.) Be sure you have grasped the handle for the correct engine before you operate it. If the answering pointer moves to the wrong sector, does not move at all, or moves to a line between two sectors so that you are in doubt about the speed set on the engine, repeat your operation on the lever. If the pointer does not move to

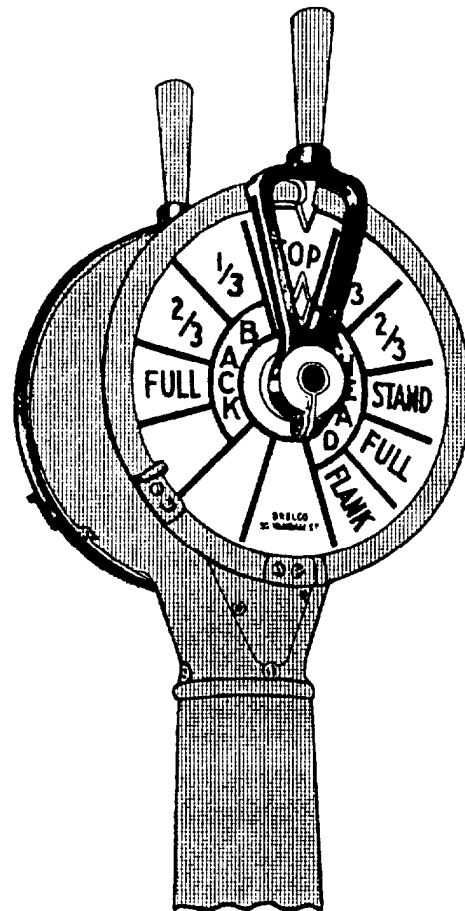

Figure 2-8.— Engine order telegraph.

clear up the riddle, report the situation immediately to the officer of the deck.

If a casualty occurs in the engine room, the speed may be changed by the engine room without orders from the officer of the deck. In such an event, the answering pointer moves to the speed set in the engine room. Report any change in the engine order telegraph to the officer of the deck at once. Also report to the OOD immediately if you fail to receive an answer on the pointer when you indicate a speed. The safety of your own ship and others may depend on the immediate and correct transmission of orders to the engines.

Before getting underway, the telegraph is always tested by moving the handle to each sector, and checking the response on the answering pointer. In the event of casualty to the telegraph, the engine room receives orders over the sound-powered phones.

ENGINE REVOLUTION TELEGRAPH

On or near the engine order telegraph, you normally will find another device, the propeller order

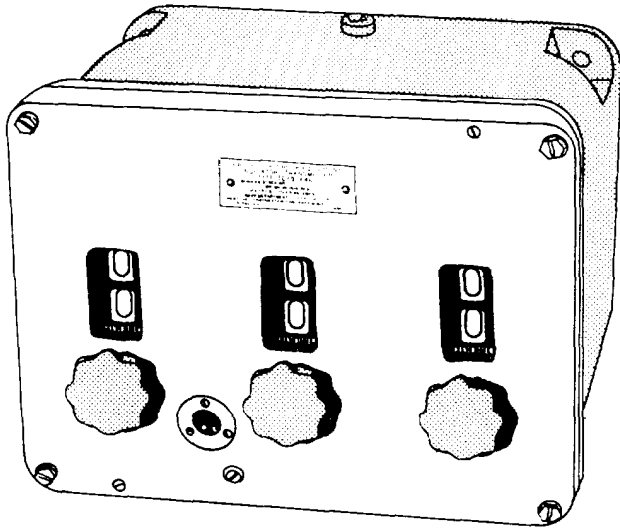

Figure 2-9.— Propeller order indicator-transmitter.

indicator-transmitter. See figure 2-9. It is commonly called the engine revolution telegraph. This instrument enables the lee helmsman to make minor changes in speed by stepping up or lowering the rpm. On the face of the instrument are three small windows, in each of which appear two rows of numbers. The lower row of numbers is set individually by the three hand knobs located directly below the windows. These lower numbers give a visual indication of shaft revolution

ordered by the conning officer to the engineroom. Corresponding numbers appear on a similar instrument in the engineroom(s) by means of electrical transmission. In the engineroom(s), these orders are received and acknowledged when the engineroom instrument is set on the same settings. Once again, this indication is transmitted back to the bridge electrically and is shown as the upper row of numbers. Thus, the operator at the conning station is able to report to the conning officer the receipt of the order for engine speed and that it is being carried out.

During the many different conditions of steaming, individual commands usually establish orders regarding when and in what manner the engine order telegraph and engine revolution telegraph are used together or separately. Usually it is found that the engine order telegraph is used alone during periods of piloting, whereas during periods of normal steaming, the engine revolution telegraph may be the primary means of transmitting speed changes. In general, however, both means are used when steaming under normal conditions. Be sure you know the exact orders relating to their use before taking over a watch on the bridge.

The number of revolutions per minute required to travel at the various speeds (full, standard, 2/3, and so on) are calculated in advance and are posted on a table nearby.

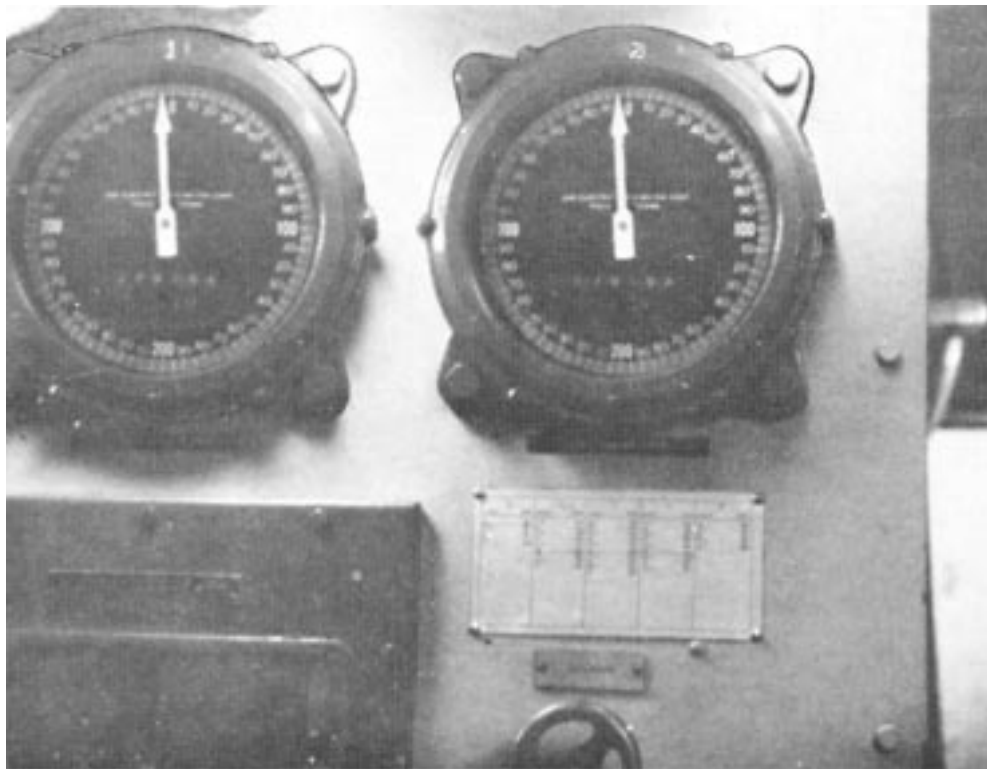

Figure 2-10.— Engine revolution indicator.

When standard speed is ordered, the number of revolutions per minute required to produce that speed must be set on the engine revolution telegraph if the revolution counter is being used.

When not in use, the telegraph on the bridge may be set to 999 or (on some telegraphs) to M (for maneuvering). This setting indicates to the engineroom that the ship is on maneuvering bells.

Although control of the engine order telegraph usually can be shifted from the bridge to an after conning station by a selector switch, control of the engine revolution telegraph cannot be shifted in this manner in most installations.

An engine revolution indicator (or tachometer) on the bridge shows the number of revolutions per minute actually being made by each shaft. This device is only an indicator and is incapable of transmitting orders. See figure 2-10.

CONSOLES

Many ships are equipped with ship control and steering control consoles.

Ship control and steering control consoles normally are installed in the pilothouse and serve as a direct method of controlling the ship. These consoles concentrate in one location many of the interior communication units formerly scattered in several places about the bridge. The units are combined in two consoles, which usually weigh less and require less space than if the same units were installed separately. Components of the consoles are mounted so that they are easily visible and accessible to the personnel concerned with the control of the ship.

Ship Control Console

The ship control console contains equipment for controlling the movements of a ship. Figures 2-11, 2-12, and 2-13 show three types of ship control consoles in

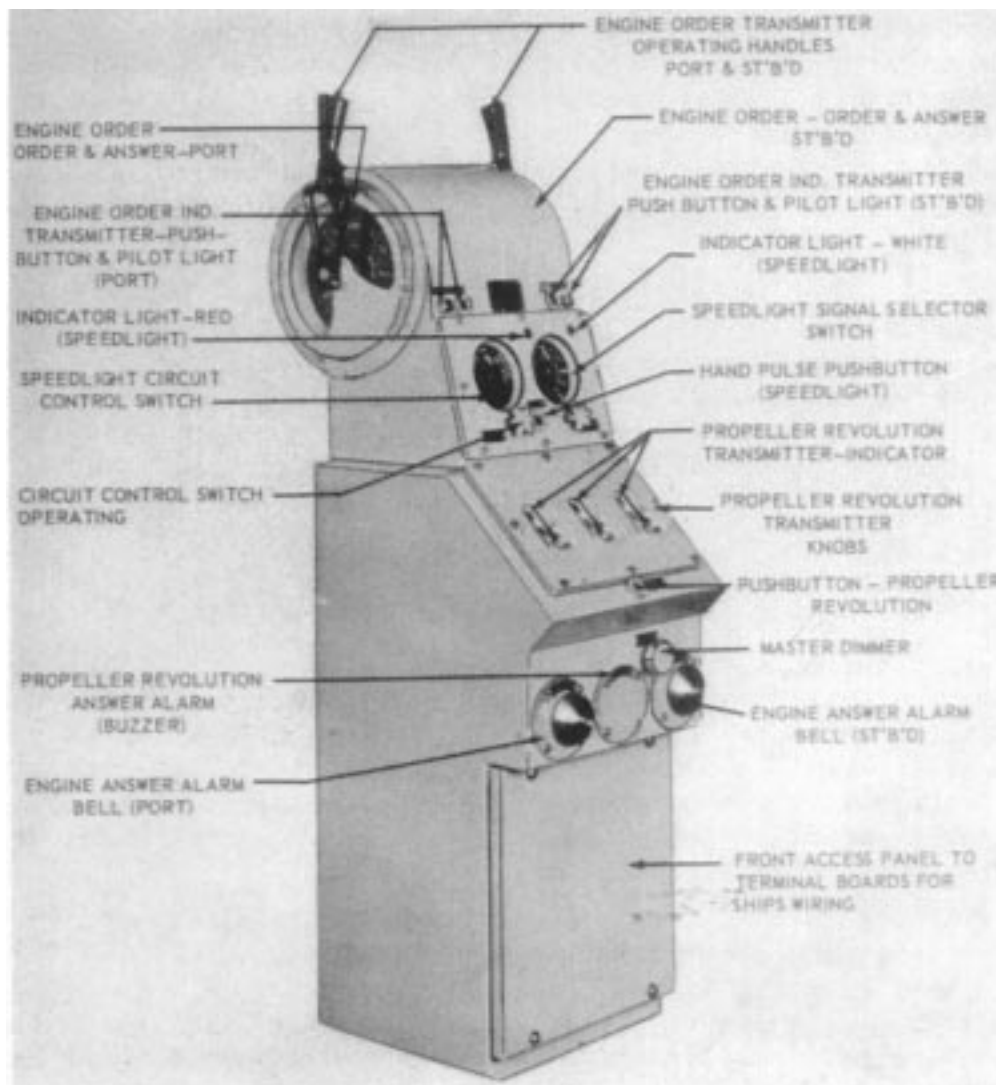

Figure 2-11.— Ship control console.

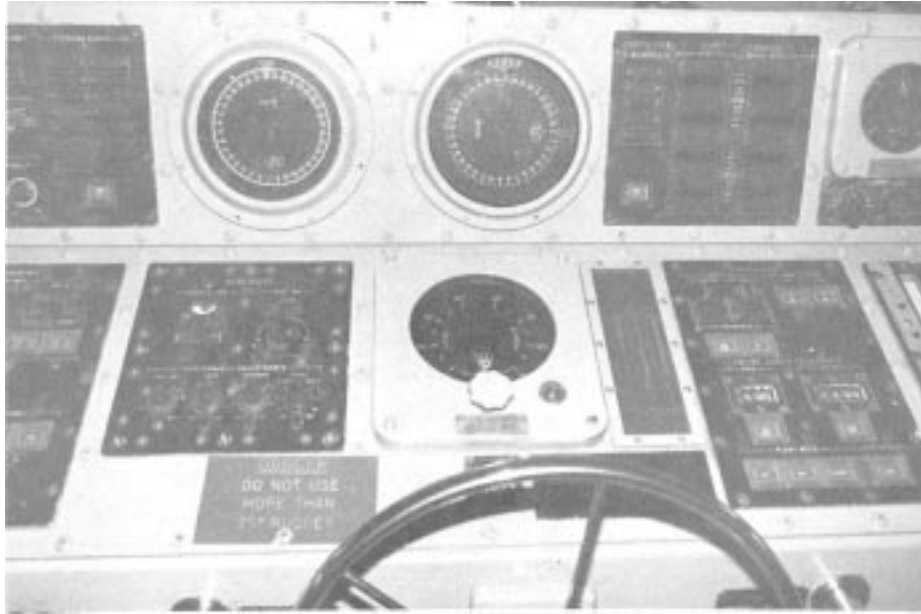

Figure 2-12.— DD-963 ship control console.

use aboard ships today. As you can see from these illustrations, the physical appearance may differ from ship type to ship type.

Steering Control Console

The steering control console (fig. 2-14) is used in conjunction with the ship control console. It includes the rudder angle order indicator-transmitter, helm angle indicator, ship's course indicator, course-to-steer indicator, magnetic compass repeater, and emergency steering switch.

FATHOMETER

Ships are equipped with a sonic fathometer, whose principle of operation is based upon the fact that sound travels through water at about 4,800 feet per second. The fathometer sends out a signal, which bounces off the ocean floor and returns to the ship much like an echo. Obviously, half of the time (in seconds) required for the sound to make the round trip, times 4,800 is the distance to the bottom, in feet.

The set includes a compact receiver-transmitter unit in the charthouse, and a transducer on the bottom of the ship. In spite of its small size, the fathometer gives a very accurate reading at a wide range of depths, from about 5 feet to 6,000 fathoms. It is designed for use on both submarines and surface vessels.

NAVIGATIONAL LIGHTS

LEARNING OBJECTIVE: List and explain the purpose of the navigation lights aboard ship.

The navigational lights installed on naval vessels must be in accordance with *Navigation Rules, International-Inland*, COMDTINST M16672.2B, or as allowed by an existing waiver or a waiver to be issued covering a vessel being built. These lights consist of (1) running lights, (2) signal lights, and (3) anchor lights. Figure 2-15 shows navigational lights onboard a vessel underway.

RUNNING LIGHTS

Running lights of naval ships are similar to those used on merchant ships. They include the (1) masthead light, (2) second masthead light (range light), (3) port and starboard side lights, and (4) stem light (white). Some of these running lights are illustrated in figure 2-16.

The masthead light is a white light (fig. 2-16, view A) located on the foremast or in the forward part of the ship, between 6 and 12 meters above the deck. It has a spraytight fixture and is equipped with an inboard shield to show an unbroken light over an arc of the horizon of 225°; that is, from right ahead to 22.5° abaft the beam on either side.

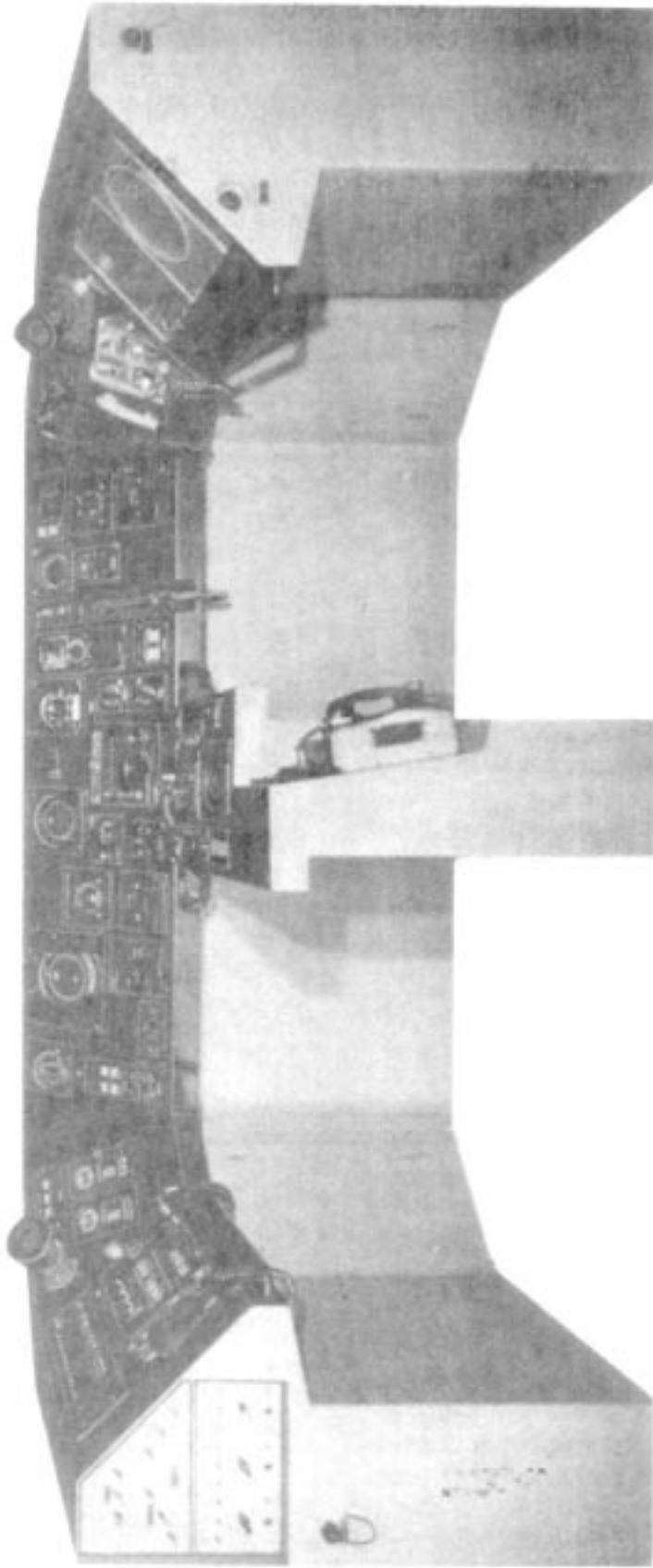

Figure 2-13.-FFG-7 class ship control console.

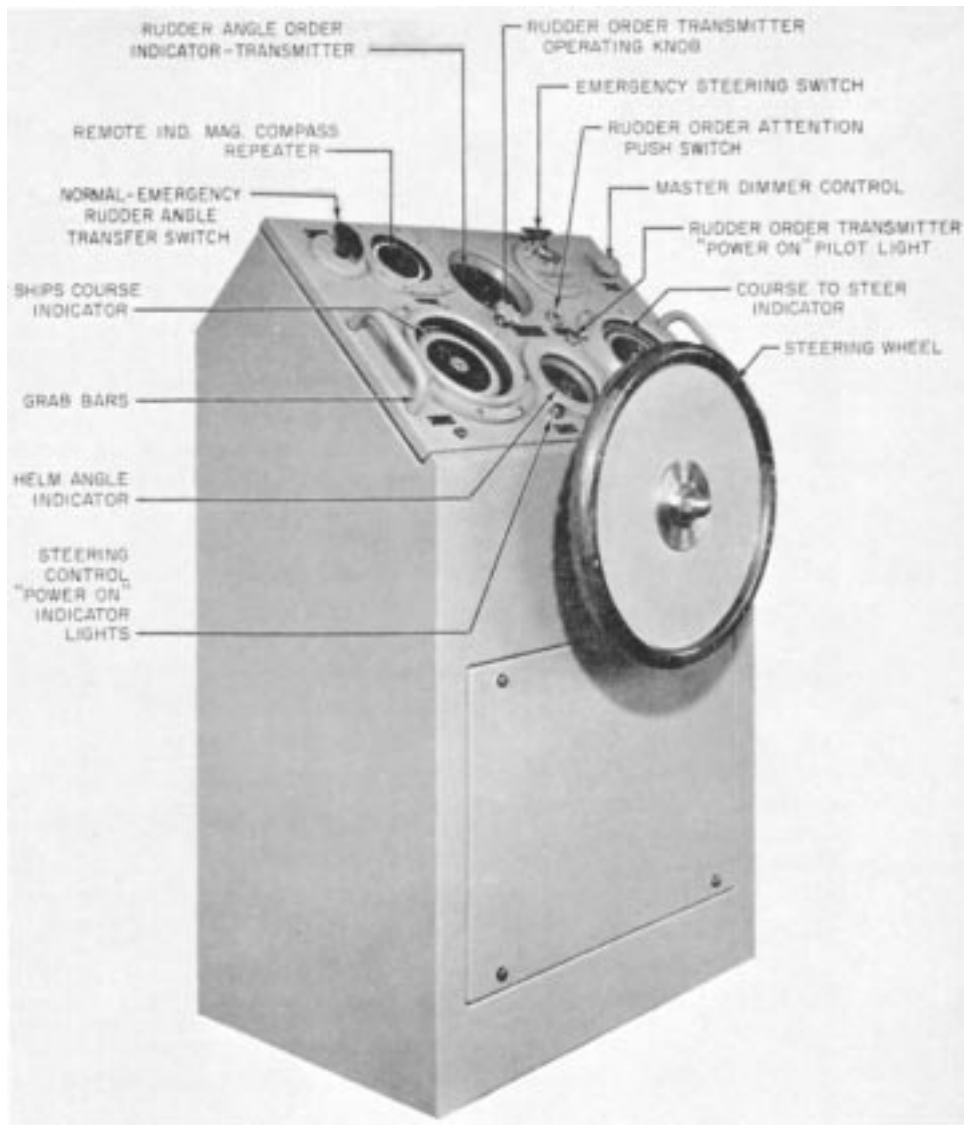

Figure 2-14.— Steering control console.

The second masthead light, also a 225° white light, is mounted on the mainmast or the forepart of any ship 50 meters in length or longer, but at least 4.5 meters higher than the masthead light.

Port and starboard side lights are 112 1/2° lights (fig. 2-16, view B) on the respective sides of the ship. They show red to port, green to starboard, and are invisible across the bow. The fixtures are spraytight, and each is equipped with an inboard screen arranged to throw the light from right ahead to 22.5° abaft the beam, port and starboard.

The stern light is a 135° white light (view C) located on the stem of the vessel. It is a watertight fixture and is equipped with an inboard screen to show an unbroken light over an arc of the horizon of 135°, that is, from dead astern to 67.5° on each side of the ship.

The supply, control, and telltale panel for the running lights is a non-watertight, sheet steel cabinet designed for bulkhead mounting (fig. 2-17). This panel is located in the pilothouse. It affords an audible and visible signal when the primary filament burns out in any one of the five running lights. At the same time, the panel switches automatically to the secondary filament so that the defective light remains in service. A master control switch with an indicator light is also located on the running light supply, control, and telltale panel.

SIGNAL LIGHTS

Signal lights installed on combatant ships usually include (1) aircraft warning lights, (2) blinker lights, (3) breakdown and man-overboard lights, (4) steering light, (5) stem light (blue), (6) wake light, and (7) speed

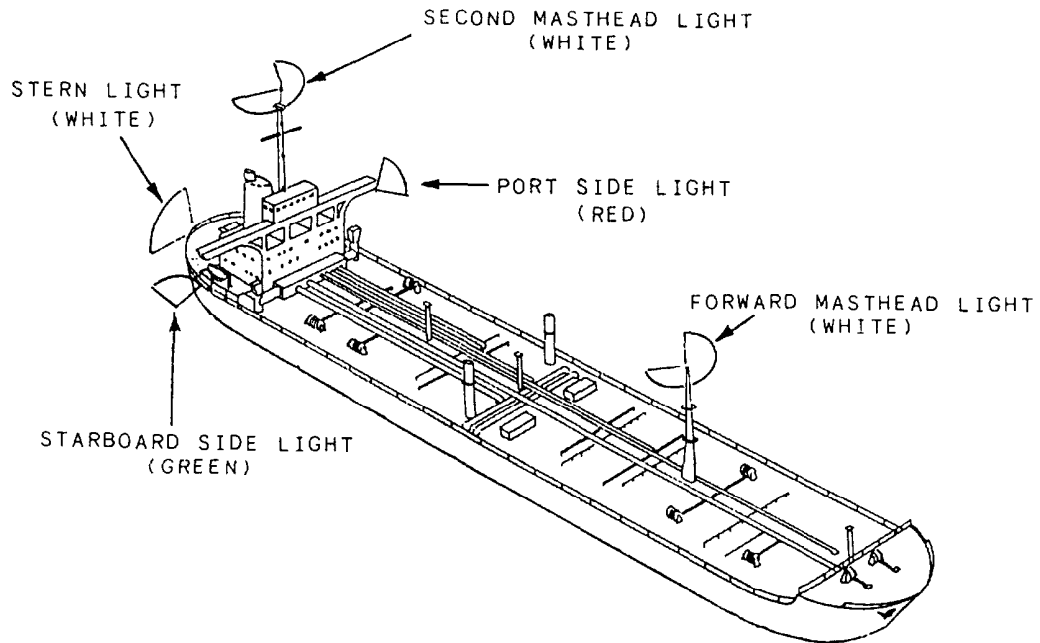

Figure 2-15.— Navigational lights on a power-driven vessel 50 meters or greater, underway.

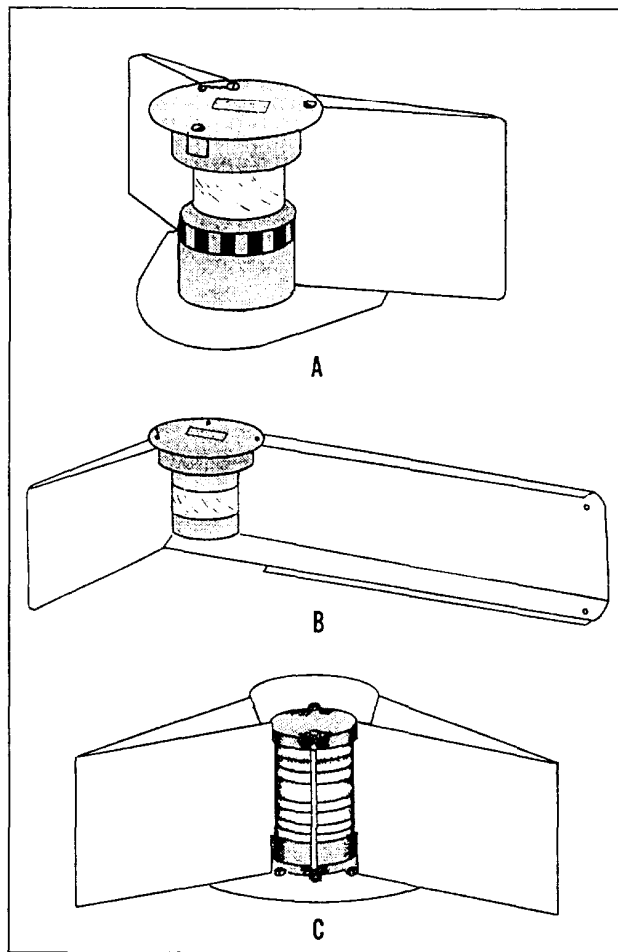

Figure 2-16.— Running lights.

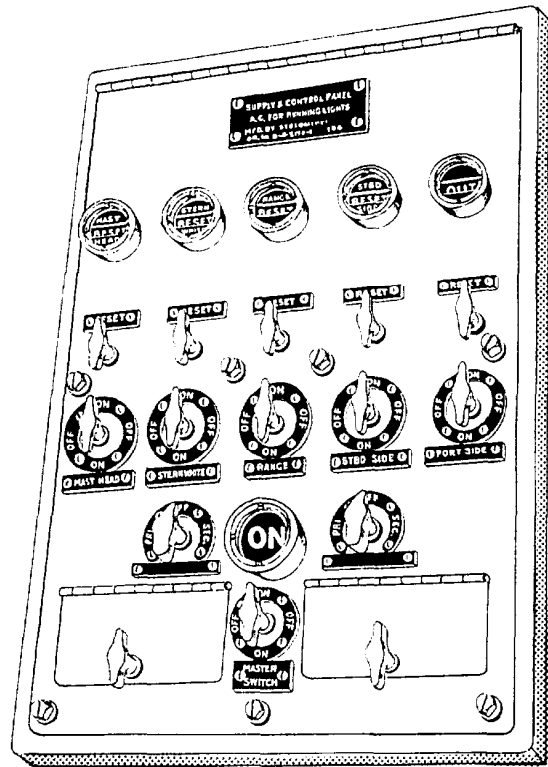

Figure 2-17.— Supply, control, and telltale panel.

lights. Supply switches for these lights are located on the signal and anchor light supply and control panel (in the pilothouse). The switches are individual on-off rotary snap switches.

The aircraft warning lights (red) for ships are 32-point (360°) lights installed at the truck of each mast that extends more than 25 feet above the highest point in the superstructure. Two aircraft warning lights are installed if the light cannot be located so that it is visible from any location throughout 360° of azimuth. The fixtures are spraytight and are equipped with multiple sockets provided with 15-watt, 1-filament lamps.

Blinker lights for ships are located on the yardarms. They are used in sending flashing light messages.

The breakdown and man-overboard lights (red) for ships are 32-point (360°) lights located 6 feet apart (vertically) and mounted on brackets that extend abaft the mast or structure and to port. This arrangement permits visibility, as far as practicable, throughout 360° of azimuth. The fixtures are spraytight and are equipped with 15-watt, 1-filament lamps. When these lights are used as a man-overboard signal, they are pulsed by a rotary snap switch (fitted with a crank handle) on the signal and anchor light supply and control panel.

The steering light (white) for ships is installed on the jackstaff or other spar or structure and must be visible to the helmsman in the pilothouse. The light is installed on the centerline if the pilothouse is on the centerline. If the pilothouse is not on the centerline, a vertical plane through the light and the helmsman's station in the pilothouse must be parallel to the keel line. The fixture is spraytight and includes a disk screen with a 3/64- by 1-inch slot (opening) through which light is emitted from a 2-candlepower lamp. A suitable bracket is provided with which the light is mounted on a jackstaff (1/2 inch in diameter).

The stem light (blue) for ships is a 12-point (135°) light similar to the white stern light (fig. 2-16, view C) described previously. The light is installed near the stem on a ship that is engaged in convoy operations. It is mounted to show an unbroken arc of light from dead astern to 6 points on each side of the ship.

The wake light (white) for ships is installed on the flagstaff or after part of the ship to illuminate the wake. It is so mounted that no part of the ship is illuminated. The fixture is tubular and spraytight. One end of the fixture has an internal screen with a 1-inch-diameter hole and a 2 5/16-inch-diameter by 3/8-inch-thick lens, through which light is emitted from a 100-watt, 2-filament lamp. A suitable mounting bracket is

included, with which the position of the light can be adjusted. Thus, the wake light puts a "target" in the ship's wake.

Speed lights for the ships are combination red (top) and white (bottom), 32-point (360°) lights. They are at the truck (top) of the mainmast unless height of the foremast interferes with their visibility; in that case, they are located at the truck of the foremast. Two speed lights are installed if their light cannot be located so that they are visible throughout 360° of azimuth.

Speed lights are provided to indicate, by means of a coded signal (as in table 2-2), the speed of the vessel to other ships in formation. In other words, they indicate the order transmitted over the engine order system. The white light indicates ahead speeds. The red light signifies stopping and backing.

The speed light is used as an aircraft warning light to provide a steady red light when the signal selector switch is placed in the stop position and the circuit control switch in the aircraft warning position.

ANCHOR LIGHTS

The forward and after anchor lights (white) for ships are 32-point (360°) lights. The forward anchor light is located at the top of the jackstaff or the forepart of the vessel; the after anchor light is at the top of the flagstaff. Each of the splashproof fixtures is provided with a 50-watt, 1-filament lamp. Anchor lights are energized through individual on-off rotary snap switches on the signal and anchor light supply and control panel in the pilothouse.

STANDING LIGHTS

Standing lights are dim, red lights installed throughout the interior of the ship or white lights installed on exterior deck passageways. The general purpose of standing lights is to provide the following:

1. In berthing spaces, the red lights provide just enough light to permit safe movement of personnel within the space when the regular lighting is extinguished.

2. On the limited number of established routes between the berthing spaces and the weather stations, with reduced light contrast between the interior of the vessel and the dark outside deck. The purpose of the reduced light contrast is to reduce to a minimum the period of blindness experienced by ship's personnel going to stations on the outside deck.

Table 2-2.— Speed Light Signals

SIGNAL SELECTOR SWITCH DIAL MARKINGS	PULSATIONS
Standard speed ahead	Steady white light (motor off)
One-third speed ahead	One white flash in 6 seconds
Two-thirds speed ahead	Two white flashes in 6 seconds
Full speed ahead	Four white flashes in 6 seconds
Flank speed ahead	Five white flashes in 6 seconds
Hand pulse key ahead	Manually controlled (code same as above)
Stop	Steady red light (motor off)
Slow speed back	One flash in 6 seconds
Full speed back	Two flashes in 6 seconds
Hand pulse key back	Manually controlled (code same as above)

3. White standing lights are used on exterior passageways to provide light so the ship's crew may move around the exterior of the ship with out danger of injury. These white standing lights are normally only turned on when the ship is in port or at anchor.

INTERIOR COMMUNICATIONS

LEARNING OBJECTIVE: Define the purpose and use of the various interior communications systems.

Interior communications deal with those forms of communication between a sender and a receiver aboard the same ship. Interior communications are carried out via sound and some visual methods. Communications by messenger, probably the most ancient of all methods, remains the most reliable system.

SHIP'S SERVICE TELEPHONE SYSTEM

The ship's service telephone system is similar to a dial telephone ashore. It is electrically powered and has a dial apparatus and central switchboard. By means of this system, you can communicate with any part of the ship merely by dialing a number. When the ship is alongside, the ship's service system can be connected with the beach to permit outside calls; but the switchboard, which functions automatically for interior

communications, must be manned by an operator for outside calls. Ship's service phones normally are equipped with light handsets, which are easy to manage, and you do not have to talk any louder or more distinctly than you would on a telephone ashore.

An ordinary ship's service phone, like any telephone ashore, sends back a busy signal if it already is in use when dialed. However, if there should be an emergency call, some phones (such as those on the bridge or quarterdeck) have an executive right-of-way feature, by which it is possible to break into a conversation in progress.

The ship's service phone has one disadvantage: The number of talkers it can reach on a single circuit is small compared to the number that can be reached by the sound-powered battle phones.

SOUND-POWERED-TELEPHONE SYSTEM

The battle telephones are sound-powered; that is, instead of a battery or generator, your voice provides the power for the circuit. Failure of the electrical power system has no effect upon the sound-powered phones, although one or more stations can be knocked out by a direct hit. You should remember that every sound-powered receiver is also a transmitter, and vice versa. In other words, if all but one earpiece on a sound-powered headset is knocked out, you normally can continue to both talk and receive through the earpiece.

The primary battle telephone circuits provide means for communication between selected battle stations grouped on established circuits. No dialing is necessary; when you plug in to one of these circuits, you can communicate immediately with anyone who is plugged in on the same circuit. Additional stations not on the circuit may be cut in by a switchboard, which also can cut out stations on the circuit if desired.

Since as many as 30 stations may be on the same circuit, strict compliance with standard telephone talker's procedure and terminology is important. Everything a talker should know may be found in *Basic Military Requirements*. As a watchstander, you must be thoroughly familiar with it.

Battle telephone circuits vary in number according to the size and mission of the ship. Circuits are designated by standard symbols, each symbol consisting of two or possibly three letters. The first letter is always *J*, indicating a circuit that is part of the primary sound-powered-battle-phone system. The other letter or letters designate a subdivision circuit of the main system, as shown in the list given in the next topic.

Any subdivision of the system may be subdivided even further. In that event, each separate circuit is identified by a number before the symbol- *IJS*, for example. Some circuits used exclusively for operations in a single department may have no outlets on the bridge or may have outlets that are used only in special circumstances.

THE J CIRCUITS

It is possible that not all of the circuits listed here may be installed in the ship you are serving on, but you never know when you may be transferred. For this reason, you should learn them now.

JA	Captain's battle circuit
JC	Ordnance Control
JF	Flag officer
1JG	Aircraft control
JL	Battle lookouts
2JC	Dual-purpose battery control
1JS	Sonar control
1JV	Maneuvering, docking, and catapult control
JW	Ship control rangefinders
JX	Radio and signals
JZ	Damage control

Every one of the circuits listed, if it is in the ship at all, has an outlet on the bridge. Some of them are manned all the time; most of them are manned during general quarters. You must know where the outlet for each circuit is; when the circuit should be manned; and the type of traffic it handles.

The following explanation gives the standard purpose of each *J* circuit:

The *JA* circuit is used by the commanding officer to communicate with his department heads and their assistants.

The *JC* is the weapons officer's command circuit on ships having a single-purpose main battery. The circuit is controlled by the weapons officer, but has a bridge outlet for use by the commanding officer and the OOD.

The *JF* is the flag officer's circuit, controlled by the flag. When no flag is embarked, it may be used as an auxiliary circuit.

The *IJG* is the air officer's command circuit on an aircraft carrier. The captain also uses it to transmit orders that concern only the air department.

The *JL* is the circuit over which the lookouts report. It is a most important channel of vital information to the bridge, CIC, and weapons control. In wartime, the *JL* circuit is manned under all cruising conditions. In peacetime, it is manned when circumstances require extra lookout precautions, but it may then be combined with other circuits. The controlling *JL* station is on the bridge, and the bridge talker is often designated as lookout supervisor.

On a ship like a destroyer having a dual-purpose main battery, the *2JC* circuit serves the same purpose as the *JC* on a ship having a single-purpose main battery and a separate secondary battery. Ships having both circuits use the *2JC* as the air defense officer's circuit.

The *IJS* is used as an ASW command circuit and also as a CIC dissemination circuit. When the *IJS* is used as an ASW command circuit, communication links are usually found in sonar control, CIC, UB plot, and on the bridge. This circuit enables stations on the communication link to exchange information without interrupting the constant flow of information on other circuits. On some ships the *IJS* is used to disseminate CIC information to the conning, gunnery, and aircraft control stations. The *IJS* is usually controlled by the CIC evaluator.

The *IJV*, called the primary maneuvering circuit, is the one with which the Quartermasters are chiefly

concerned. It connects the bridge and other conning stations with main engine control, steering aft, and other emergency steering stations. It has outlets on the main deck for control of the anchor detail and line-handling parties fore and aft. This circuit is always manned by CIC, and may be manned by other control stations when advisable. The conning officer controls the 1JV, and the circuit is always manned-or at least is ready for instant use-whenver the ship is underway.

The *JW* is the navigator's circuit by which Quartermasters stationed at peloruses may report directly to the navigator at the chart table. During piloting, the *JW* is connected with communication spaces.

The *JZ* circuit is the damage control circuit by which damage control parties can communicate with DC Central.

Some of the foregoing circuits may vary slightly on different ships. As soon as you report aboard a new ship for duty, you must learn the details of any possible variance.

AUXILIARY BATTLE CIRCUITS

The auxiliary battle circuits form a secondary system, consisting of sound-powered lines that are not routed through a switchboard. Most of the important circuits described previously have substitutes in the auxiliary system.

An auxiliary circuit is designated by the letter *X*, followed by the symbol of the circuit for which it is a substitute. Many circuits are equipped with call buzzers so that communication can be maintained with stations on the circuit without the circuits having to be manned continuously. A typical example is the *X1JV*, which permits the OOD to exchange communications directly with the engineering officer of the watch.

VOICE TUBE

On most mine craft, patrol boats, and the like, the voice tube still is the primary means of interior communications, although some small craft have sound-powered-phone circuits. A voice tube requires neither electrical nor sound power, but its effectiveness decreases, of course, in direct ratio to the length of the tube and number of bends it contains. On large ships, communication by voice tube is for short distances only, as between open conning stations and the pilothouse.

SHIPBOARD ANNOUNCING SYSTEMS

In the old Navy, before the days of loudspeaker systems, an all-hands order was passed by word of mouth by the Boatswain's Mates fore and aft. The boatswain or BM of the watch sounded "CALL MATES" on his pipe to get the BMs together, and they answered repeatedly with the same call from various parts of the ship as they converged on the bridge or quarterdeck. When they heard the word, they dispersed fore and aft to sing it out at every hatch.

This procedure was very colorful, but it took a lot of time. Now, a single Boatswain's Mate can pass the word over the *MC* circuit in short order, while the others stay where they are, keeping the gang heaving around. The basic *MC* circuit is the *IMC*, the general announcing system, over which word can be passed to every space in the ship. The general alarm system is tied into it as well. Transmitters are located on the bridge, quarterdeck, and central station; and additional transmitters may be at other points. See figure 2-18.

The OOD is in charge of the *IMC*. Except for possibly an emergency call by the damage control officer, no call may be passed over the *IMC* unless authorized by the OOD, the executive officer, or the captain.

Normally, the *IMC* is equipped with switches that make it possible for certain spaces to be cut off from announcements of no concern to them. The captain, for

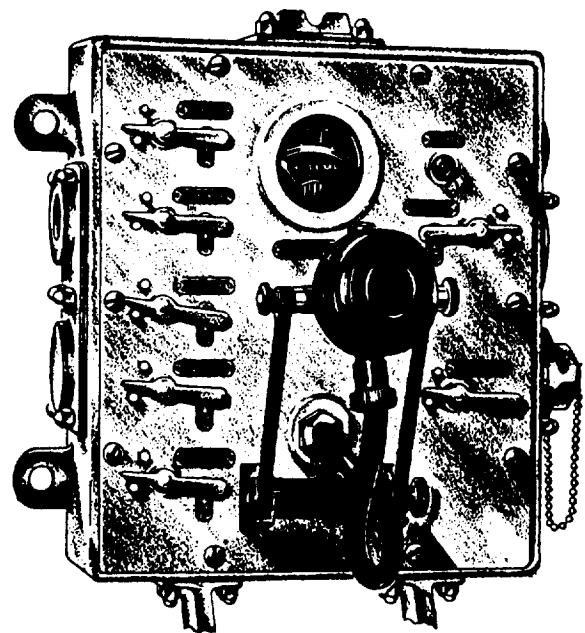

Figure 2-18.— loudspeaker transmitter.

instance, does not want the cabin blasted with calls for individuals to lay down to the spud locker. The BM of the watch is responsible for passing the word; but if he or she is absent and you are required to pass the word by yourself, be sure you know which circuits should be left open. Some parts of the ship have independent MC circuits of their own, such as the engineers' announcing system (2MC) and the hangar deck announcing system (3MC).

The bull horn (6MC) is the intership announcing system, but it seldom is used for actual communication between vessels. It is, however, a convenient means for passing orders to boats and tugs alongside or to line-handling parties beyond the range of the speaking trumpet. If the transmitter switch is located on the 1MC control panel, you must be careful to avoid accidentally cutting in the bull horn when you are passing a routine word. The 1MC, 2MC, 3MC, and 6MC are all one-way systems.

Such MC circuits as the 21MC, familiarly known as squawk boxes, differ from the preceding PA systems in that they provide means for two-way communications. Each unit has a number of selector switches. To talk to one or more stations, you need only throw the proper

switches and operate the press-to-talk button. A red signal light mounted above each selector switch shows whether the station called is busy. If it is busy, the light flashes; if it burns with a steady light, you know that the station is ready to receive.

Following is an example of how to operate the intercom. You are on the signal bridge, at the 24MC transmitter (fig. 2-19), and you want to call conn. First you push the selector button marked CONN. We will assume the line is clear for your message, which means that a steady red light appears over the SIGNAL BRIDGE selector switch at the conn transmitter. When the operator at conn pushes on the SIGNAL BRIDGE button, the signal lights at both stations begin to flash. Now you can operate the PRESS-TO-TALK button and start your message. Any other station attempting to cut in gets the flashing busy signal.

The chief disadvantage of the intercom is that it raises the noise level in any space in which it is used. For this reason, it seldom is used when telephones are manned. Intercom circuits that may be located on the bridge are identified briefly as follows:

The 20MC, combat information announcing system, connecting the same stations as the IJS

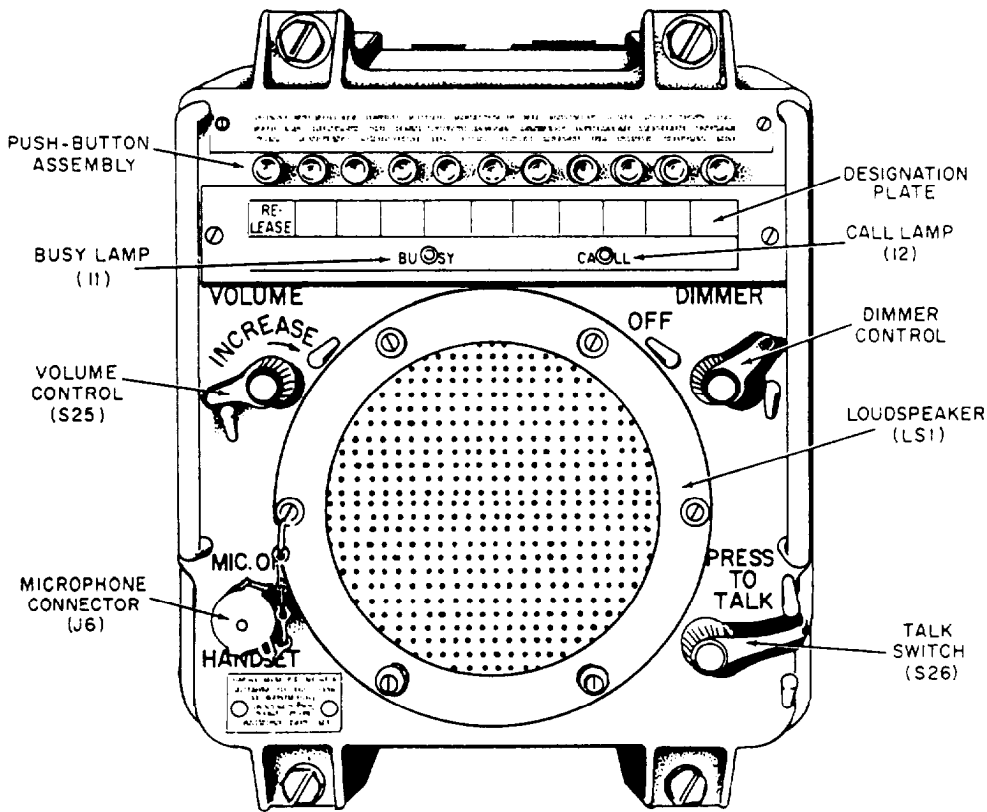

Figure 2-19.— Typical MC unit.

The 21MC, captain's command announcing system, an approximate parallel to the JA

The 22MC, radio room announcing system, a substitute for the JX

The 24MC, flag officer's command announcing system, the intercom equivalent of the JF

LOOKOUTS' EQUIPMENT

LEARNING OBJECTIVE: Explain the proper usage and care of lookout equipment.

You were born with the most important lookout equipment you will ever use—your own two eyes. In lookout work, your eyes are invaluable if you use them right. You have already learned a good deal about proper use of the eyes in night scanning and in day scanning. However, you still have much to learn about scanning and the equipment you are required to operate.

The lookout on the average ship in the Navy will have most of the following equipment:

- binoculars
- binocular filters
- sunglasses
- dark-adaptation goggles
- alidades
- peloruses
- sound-powered phones
- various articles of foul-weather gear

Although this gear may be stamped “U.S. Navy,” it is yours while you use it. And it is up to you to know how to use it and how to take care of it properly.

BINOCULARS

The most commonly used optical equipment is the binoculars (fig. 2-20). Although normally only 7 power, the binoculars gives a wide range of vision and is best suited for searching over a wide area or for following a swiftly moving target. The binoculars requires the use of both eyes; but since both eyes do not always have the same vision, it is best to adjust the focus for each lens individually. Proper focus is essential. If the focus is off, things look blurred, eyestrain is greatly increased, and maximum efficiency will not be obtained.



Figure 2-20.-7 x 50 binoculars.

Before focusing the binoculars for each eye, turn both scales to the +4 setting. Hold the binoculars firmly against your eyebrows. To get the focus for the left eye (only one eye can be focused at a time), cup the right hand over the right lens, cutting out all the light to that eye. Be sure to keep both eyes open, however, since closing one eye will give an incorrect focus. Train the binoculars on a small, well-defined object. Slowly turn the eyepiece from its +4 setting until the object stands out in sharp detail.

The reading on the scale will give you the correct focus for your left eye. Now do the same for the right eye. The chances are the setting will be different. You might repeat this focusing process for each eye several times just to make sure the focus is right.

Once you get the glasses properly focused, remember the settings. The best reason for remembering the settings is that it is difficult to focus your binoculars on a very dark night. The correct night focus is usually a -1 setting from your day focus for each eye.

The other adjustment for binoculars is the inter-pupillary distance (IPD) adjustment. All Navy binoculars have the IPD scale on the hinge between the barrels. Find out what your IPD is and remember it. When you set your correct IPD on the scale, you will see a single circle in focus. At night, if you have the wrong IPD setting, light that should be going to your eyes will be cut out.

Take a look through a pair of binoculars that is not adjusted for your eyes and then look through a pair that is properly adjusted. Notice the great difference. Keep this in mind when you see the binoculars that belong to

the captain, navigator, or officer of the deck, and never touch them.

Although most binocular glass has been treated to reduce glare, there are times when the direct rays of the sun are so strong that even with treated glass, it is almost impossible to distinguish shapes and colors. To overcome this handicap, binocular glass usually has colored lens filters, which can be inserted over the regular lenses, greatly reducing the glare.

Your efficiency with optical equipment, the same as with anything else, will greatly improve with knowledge and practice.

The care of binoculars: Your binoculars are your most important single piece of equipment. They will do a top-notch job for you if you use them properly; otherwise, they will only hinder you. Here are some suggestions:

- Treat them carefully. They are fragile and will break or get out of adjustment if handled roughly.
- Keep them "short-strapped" around your neck when in use so that they do not dangle and get knocked against ladders or the rail.
- Do not leave them in the sun; and do not expose them to sudden changes in temperature. The cement between the lenses will crack if you do.
- Above all, keep your binoculars clean! You would not drive with a dirty windshield; likewise, you should not scan with dirty binocular lenses. Both situations are dangerous! To get best results in cleaning lenses, (a) blow off the loose dust; (b) breathe on the lenses to moisten them (never breathe on the glass in freezing weather); (c) use lens tissue, or other soft, clean tissue to wipe your lenses (never use your sleeve or your handkerchief or anything that has the slightest amount of grit or grease on it). With a circular motion, gently rub the surface of the lenses until they are dry and clean. To remove grease, moisten the cleaning tissue slightly with alcohol.
- When your binoculars are not in use, see that they are properly stowed.

FOUL WEATHER GEAR

Under the best of conditions, the lookout's job is tough enough. But in rough weather, things can get really rugged. For this reason you have special types of foul weather gear. Navy issue on most ships is a special suit with hood and mask. In addition, you will have a

life jacket. But the most important part of all is up to you: Make sure you dress warmly; you cannot perform your duties efficiently if you are cold and wet.

BREAKDOWN AND MAN-OVERBOARD EMERGENCIES

LEARNING OBJECTIVE: List and identify shipboard emergency signals.

Emergencies aboard ship can be dangerous to you and to your shipmates if the emergencies are not discovered and reported immediately and if each person does not know exactly what to do and how to proceed. For this reason, breakdowns and man-overboard situations, although not watches in the strict meaning, could be considered permanent watches to be stood by all hands at all times. It is the responsibility of all hands—including you as a Seaman—to serve at all times as a lookout for either of these emergencies.

The captain of your ship requires that all hands be trained by frequent drills to meet these situations. Do not look lightly on this training; loss of your own life and that of your friends could be the price of inattention.

Breakdown and man-overboard situations require extremely rapid action on the part of the officer of the deck and assistants to the OOD. You should always consider yourself one of these assistants while aboard ship. Saving the life of a person overboard depends on the speed with which rescue action is taken. The captain, executive officer, and OOD must be notified immediately of either emergency.

BREAKDOWN SIGNALS

The breakdown flag is the FIVE flag. It is kept made up for breaking at the foretruck, ready to be broken should any breakdown of equipment vital to the ship's running or steering occur during daylight hours. When broken (flying free), it warns other ships to keep clear of the disabled ship. When a breakdown is discovered during daylight hours, the following procedure is put into effect immediately:

1. The five flag is displayed (Navy use only).
2. Two black balls are hoisted.
3. Six or more short blasts are sounded on the whistle.

Two red lights in a vertical line are displayed to signal a breakdown at night, in lieu of the five flag and the two black balls.

MAN-OVERBOARD SIGNAL

The man-overboard flag is the OSCAR flag displayed at the foretruck or where it can best be seen during daylight hours. When someone goes overboard at night, the peacetime procedure is the display of two blinking red lights arranged vertically. In addition, either by day or night, the ship losing the person sounds six or more short blasts on the whistle.

Man-Overboard Procedure

Only the ship losing a person overboard may make the signals described in the foregoing section. Action taken by other ships in a formation or around the ship losing the person overboard depends on existing conditions. If at all possible, the person overboard is to be rescued, but collisions must be avoided.

The peacetime (standard) practice for a ship losing a person overboard follows:

1. Anyone aboard ship who sees a person fall overboard must shout as loud as possible and without hesitation, "MAN OVERBOARD, STARBOARD (PORT) SIDE." This call must be repeated until the conning officer takes necessary action or indicates in some way that the word was received.
2. Rudder and engines are used, if appropriate, to avoid hitting the person with the screws.
3. A lifebuoy and smoke float are dropped.

When launching a Mk 6 smoke float, (a) remove the tape from over the pull ring, (b) pull the ring smartly from the device, and (c) immediately throw the smoke float over the side. Do NOT remove the tape from over the pull ring until just before launching. Salt air will rust the pull wire, causing it to break and thereby making the device useless.

4. At least six short blasts are sounded on the whistle.
5. By day the OSCAR flag is hoisted where it can be seen best. By night, two pulsating red lights arranged vertically are displayed. (In peacetime any ship may use searchlights as necessary.)
6. The ship is maneuvered as prescribed by doctrine.

7. In formation, the officer in tactical command (OTC) of all ships present is notified.

Signals to Lifeboat

The following signals are used to direct a lifeboat engaged in picking up a person overboard.

Flag or Blinker	Pyrotechnics	Meaning
8	1 white star	Steer straight away from ship
8 PORT	1 red star	Steer left (or to port)
8 STARBOARD	1 green star	Steer right (or to starboard)
8 SCREEN	2 green stars	Steer straight toward ship
QUEBEC	2 red stars	Return to ship
	2 white stars	Steady on present course

Lifeboat Signal to Ship

When a lifeboat is attempting to pick up a person overboard at night, the following signals are used from the boat to the ship.

Visual Signals	Pyrotechnics	Meaning
Blinker or semaphore	1 green star	Cannot find person
	1 white star	Have recovered person
	1 redstar	Need assistance

SUMMARY

You should have learned in this chapter the various watchstander's equipment used on the ship's bridge. Failure to use proper nomenclature or a lack of basic knowledge of a ship's equipment is unprofessional and may, in an emergency, lead to dangerous confusion.

As an underway watchstander, you will perform, on occasion, routine checks or tests on bridge equipment as either the messenger of the watch or the helmsman.

Know your job and keep your equipment in good working order so you can do an outstanding job!

CHAPTER 3

MARLINESPIKE SEAMANSHIP

Marlinespike Seamanship is the art of handling and working all kinds of fiber and wire rope. It includes every variety of knotting, splicing, serving, and fancy work. Although canvas and leather work are not part of marlinespike seamanship, we will briefly discuss them in this chapter.

You will find marlinespike seamanship easy to learn if you master the basic knots before you try the fancy work.

This chapter is important because you will handle and work with all kinds of line and wire rope aboard ship.

For example, you will use line for tying up during mooring and docking and for rigging aloft or over the side during painting details. You will also use wire rope during replenishment of supplies and for highline transfers. These are only a few of the jobs that require you to use line or wire rope; there are many more. Learning the proper care and methods of handling line and wire rope and practicing these techniques are an essential part of your job as a Seaman.

ROPE

LEARNING OBJECTIVE: Explain the construction, use, care, and other characteristics of wire rope and line.

Rope is manufactured from wire, fiber, and combinations of the two. Fiber rope—or line, as it is commonly called—is fashioned from natural or synthetic fibers. Lines made from a variety of natural fibers (cotton, agave, jute, hemp, sisal, and abaca) have seen service in the Navy in the past, and some are still used. For example, tarred hemp is known as marline and ratline. On the other hand, sisal may still be found as a wire-rope core. Manila (made from the fibers of the abaca plant) formerly was authorized for use only where great strength was required. Now, manila is authorized for lashings, frapping lines, and steadying lines. However, synthetic lines have replaced manila in most applications.

Rope, a general term, can be applied to both fiber rope and wire rope. In the Navy, sailors refer to fiber

rope as *line*, whereas they refer to wire rope as *rope*, *wire rope*, or just *wire*. More clearly defined, a *line* is a piece of rope, either fiber or synthetic, that is in use or has been cut for a specific purpose, such as a lifeline, heaving line, or leadline.

This chapter discusses the fundamental uses and care of rope of all kinds. Knots and splicing may be difficult to understand, so do not hesitate to ask for help from a more experienced hand.

CONSTRUCTION OF LINE

Line currently used in the Navy may be three-strand line, braided, or plaited. In three-strand line, fibers are twisted into yarns or threads, the yarns are twisted in the opposite direction into strands, and the strands are twisted in the first direction, making line. Taking the process further, lines are twisted into cable. Line can have various numbers of strands, and the direction the strands are twisted determines the lay of the line. That is, if the strands are twisted to the right, the line is said to be right-laid.

Four-strand line is right-laid strands around a center core. Each strand is aramid fibers laid into parallel yarns left laid helically around the strand core with a braided helical of alternating aramid and polyester yarns.

Braided lines have certain advantages over twisted ropes. They will not kink nor will they flex open to admit dirt or abrasives. The construction of some braids, however, makes it impossible to inspect the inner yarns for damage. The more common braided lines are hollow braided, stuffer braided, solid braided, and double braided lines.

Hollow braided lines usually have an even number of parallel, tapelike groups of small yarns braided into a hollow, tubelike cord. This type of construction in cotton formerly was used for signal halyards—a purpose now served largely by three-strand and double braided nylon. Other uses are parachute shroud lines and shot lines for line-throwing guns.

Stuffer braided lines are manufactured in a similar manner except that the braid is formed around a highly twisted yarn core, which rounds out and hardens the

line. This type of construction in cotton is used for sash cord (heaving lines).

Solid-braided lines are fashioned in various ways. One familiar construction is that used for leadlines, taffrail log lines, and the like. This braid is of large yarns, either single or plied, tightly braided to form a hard, relatively stiff line that will not kink, snag, or swell in water.

Single braided line consists of 12 strands in a twill pattern, where one strand of one direction of rotation about the axis of rope passes over two strands of the opposite direction and then passes under the next two strands of the opposite direction. Single braided line is used for mooring lines and towing hawsers.

Double braided line is, essentially, two hollow braided lines, one inside the other. The core is made of large, single yarns in a slack braid. The cover is also made of large, single yarns but in a tight braid that compresses and holds the core. Double braided line is manufactured only from synthetics, and about 50 percent of the strength is in the core. It is used for mooring lines, towing hawsers, signal halyards, dressing lines, and many other purposes.

Plaited line is made of eight strands—four right-twisted and four left-twisted. The strands are paired and worked like a four-strand braid. Consequently, there are two pairs of right-hand strands and two pairs of left-hand strands formed into a line that is more or less square. Plaited line is used for towing hawsers, ship mooring lines, messengers, and other applications.

USE AND CARE OF LINE

Manila line is not used as it once was. The replacement lines for the personnel highline, the inhaul and outhaul lines, the light freight transfer line, and the replenishment-at-sea messenger are made of spun polyester. Other synthetics have taken over other uses with some exceptions where manila will be retained.

Manila lines of 4 inches or more should be reserved for fueling-at-sea riding lines.

Following are some pointers on the use and care of fiber line for you to remember:

- Coil right-laid line right-handed or clockwise. Flake down braided and plaited line.
- Keep line from touching stays, guys, or other standing rigging.

- When surging line around bitts, take off enough turns so the line does not jerk but surges smoothly.

- If line becomes chafed or damaged, cut and splice. A good splice is safer than a damaged section. However, do not cut a line without your supervisor's permission.

- Do not lubricate the line.

- Whip all line ends.

- Inspect natural fiber line frequently for deterioration. Open the lay and inspect the fibers. White, powdery residue indicates internal wear.

- Dragging a line over sharp or rough objects cuts or breaks the outer fibers. When line is dragged on the ground, other particles are picked up and eventually work into the line, cutting the inner strands.

- Natural fiber line exposed to the atmosphere deteriorates about 30 percent in 2 years from weathering alone. Natural fiber line received from supply that is 3 years old should be returned to supply noting uneconomical to use.

WARNING

If a natural fiber line is more than 5 years old (either used or unused), you must not use it for critical operations or those involving the lives of personnel. You can use these lines only for lashing, fenders, and matting.

- Line loaded in excess of 40 percent of its breaking strength can be permanently damaged. Inspection of the inside yarns reveals whether they are broken. Synthetic line that has been overstressed will have inside yarns fused together.

SMALL STUFF

LEARNING OBJECTIVE: Identify small stuff line.

Line 1 1/2 inches or less in circumference is called small stuff. Its size specification is governed by the number of yarns it contains (called threads in this instance).

Line larger than 1 1/2 inches in circumference is always designated in size by its circumference in inches. In general, any line larger than 5 inches that is used in towing, mooring, and similar operations is

called a hawser. Remember, it is the size around (the circumference) the line that is measured, not the diameter.

SIZE OF SMALL STUFF

To find the size of a piece of small stuff, open a strand, count the number of threads it has, and multiply this result by 3 for three-strand stuff. The largest small stuff is 24-thread, with three strands each containing eight yarns.

USE OF SMALL STUFF

Certain small stuff used for special purposes is designated by name, with no reference to size. Marline is the most common stuff of this type seen aboard ship. Dark brown in color, it is two-strand, left-laid tarred hemp. It is inexpensive, fairly strong, and protected against the weather by its tarring.

Housing line is three-strand, left-laid tarred hemp. It is used for light seizings, serving pennants, riggings, and outside work exposed to weather.

Round line is three-strand, right-laid tarred hemp. It is used for seizings and servings on ships where neatness is required.

Sail twine is small stuff laid up right-handed by machine, like regular line, but it is not much larger than fishing line. It is used for servings when a fancier job than can be done with marline is desired.

Cod line is the light, white line formerly used in hammock clews (lines for suspending a hammock). It now is used for decorative purposes.

Rope yarns for temporary seizings, whippings, and lashings are pulled from large strands of old line that has outlived its usefulness. Pull your yarn from the middle, away from the ends, or it may get fouled. Keep an old strand about a fathom long hanging in the boatswain's locker for this purpose.

Small coils of line may be loaded into a cargo net and hoisted aboard. Large hawsers may be hoisted in a sling placed around the ends of a piece of pipe or a crowbar shoved through the center tunnel of the coil. The large hawsers may also be rolled forward along the deck, hoop fashion, and jiggered into place by the same rig.

STOWING SMALL STUFF

Coils of natural fiber line should always be stowed on shelves or platforms clear of the deck. They should never be allowed to become covered with an accumulation of junk that may prevent the evaporation of moisture. Always remember that line composed of natural fiber is susceptible to mildew and rotting.

Arrange the coils of small stuff along a shelf according to its size. Set each coil up with the inside end at the bottom of the center tunnel so it come open properly. The burlap wrapper should be left on each coil. You will find that the stoppers for securing the coil are inside the wrapper. Cut these stoppers and draw up the inside end so the line is started properly. It is a common custom—and a good idea—to set up a narrow, flat strip of wood horizontally over the shelf containing the small stuff, with a hole bored in the strip over each coil. The starting end of the line is drawn up through the hole, and is prevented from dropping back by an overhand knot. This method ensures that anyone coming down for a piece of small stuff need not grope around inside the tunnel for the end, with the possibility of getting hold of the wrong end when the coil is pretty well depleted.

The most commonly used sizes of small stuff should be put on reels; then you will not have to worry about somebody fouling up a partially used coil.

Once the stoppers of the coil are cut, bights of tightly wound coils of marline have a tendency to work off the ends of a coil and become hopelessly snarled. To prevent snarling, transfer the marline to a reel. Take a short length of pipe or a squeegee handle, and shove it through the center of the coil. Block it up so the coil is free to turn. In this case, take the outside end of the marline, secure it to the reel, and start laying it up. You will need help with this job because the coils must be tended carefully to prevent bights from slipping off the ends of the coil.

Coils of large line should be stowed with their proper side up for opening. Line from 2 to 4 inches or so, which is needed in various lengths on deck, should be opened and a few feet of the end led out.

When a new coil of line is to be opened, give it your personal attention. Five minutes of your time here may save hours later trying to work kinks out of an improperly opened coil.

Whenever possible, wet line should be dried thoroughly before stowing. Sometimes drying is impossible, as with mooring lines that must be sent

below before the ship gets outside in heavy weather. If line must be stowed wet, it should be laid up on gratings in long fakes so that it may dry as quickly as possible. It should never be covered over.

SYNTHETIC FIBER LINES

LEARNING OBJECTIVES: Describe the general usage and care of synthetic line. List safety precautions for handling synthetic line.

Aramid, nylon, polyester, polypropylene, and polyethylene, in the descending order of strength are the synthetic fibers used to make line.

Synthetic fiber line has several advantages over manila. Size for size, it is 1.7 to nearly 6 times as strong and lasts 5 times as long. On a strength for strength basis, a synthetic fiber line of less than half the size of a manila line is required for the same task. For these reasons, synthetic fiber is cheaper in the long run, even if its initial price is more. Because synthetic fiber does not rot or age as does natural fiber line, its strength is more stable throughout its life. It is less bulky, more flexible and, therefore, easier to handle and requires less stowage space. Other advantages, and a few disadvantages, are pointed out later in this discussion.

NAVSEA has also approved a new synthetic fiber, aramid fiber line (Kevlar), for use aboard ship as mooring and tending lines. aramid rope is lighter, easier to handle, and smaller than nylon or polyester of equivalent strength. It also requires less hawser reel storage space. However, since it stretches only 6 percent at minimum breaking strength, tattle-tale cords cannot be used to determine the strain on their line, and the line will respond differently compared to other synthetic lines, which stretch 30 to 65 percent at minimum breaking strength. Also, this aramid line does not fuse and smoke when surged around the bits. The line surges smoothly around bits compared to other synthetic mooring lines. Aramid line safety precautions that should be observed will be discussed later.

A coil of synthetic fiber line, unlike natural fiber line, is not opened by pulling the end up through the eye of the coil. It should be unreeled in the same manner as wire rope. (See the section on Wire Rope in this chapter.) Normally, plain-laid nylon line is right-handed and should be coiled on capstans and reels in a clockwise direction. Cable-laid nylon or synthetic line is left-laid and should be coiled on capstans or reels in a counterclockwise direction.

Because of the characteristics of synthetic line, safety precautions more explicit than those for manila line must be observed. A complete list of precautions is located in chapter 613 of the *Naval Ships' Technical Manual* (NSTM), but some of the more important safety precautions to be observed are listed below:

1. Because of the lower coefficient of friction of synthetic fiber line, exercise extreme care when a line is being payed out or eased from securing devices (bits, cleats). For control in easing out, take two round turns and no more than two figure-eight bends. Any more than this will present danger to personnel and difficulty in handling the line. All lines on capstans and gypsy heads shall be payed out using power and never by surging. Figure 3-1 shows the method of securing a mooring line to the bits.

2. Since a snap-back action inevitably occurs when a line parts under tension, never allow personnel to stand in the direct line of pull of the line when it is being pulled or when it is under tension. A synthetic line parting under tension will snap back at near the speed of sound, and reaction time to clear the area will not be available. Where possible, position line handlers 90° from the direction of the tension force (fig. 3-2).

3. Synthetic line has higher breaking strengths than equal sizes of manila line. Failures of blocks, pad eyes, shackles, and line couplings can be caused by improper substitutions. For this reason, personnel should determine the identification and capacity of all gear and fittings used with synthetic fiber line to ensure that their strength exceeds the minimum breaking strength of the line.

4. Synthetic line has poor knot-holding characteristics. Some knots that offer good characteristics for securing manila line, such as the square knot, are not adequate for belaying or securing synthetic line. The bowline is one knot known to offer reasonable security when bending together or securing synthetic line.

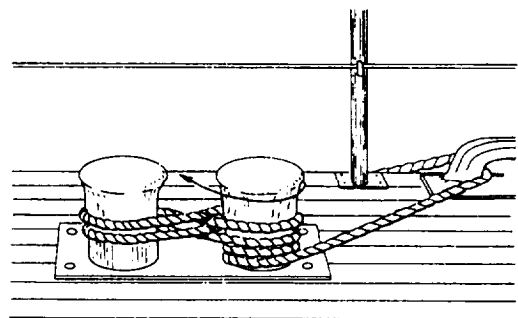

Figure 3-1.—Securing lines to bits.

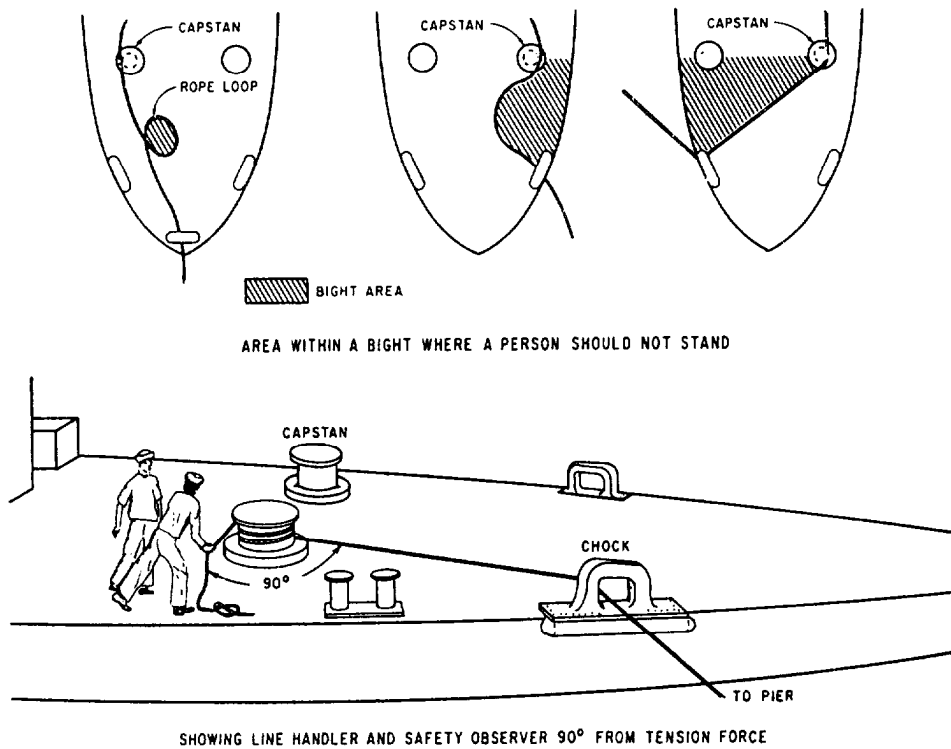

Figure 3-2.—Safe work areas.

5. Do not mix lines of different materials or constructions. This is an unsafe practice because unequal stretch results in unequal loading.

6. Shiphandlers and linehandlers should be made aware the new aramid line is a low-stretch line and that it does not neck down appreciably when put under a strain. The strain should be carefully controlled to avoid excessive tension. This is best accomplished by having linehandlers check the line frequently until they have the feel of it.

7. As with all other lines, it is recommended you use chafing gear where aramid lines pass through chocks. If the cover of any strand of the aramid line is abraded to the extent that the inner fibers are visible but not damaged, the strand or entire line may be served with marline or synthetic cord. If the inner fibers are damaged, you must cut out that section of the line and re-splice it.

The three following safety rules for line-handling must be heeded regardless of the line fiber material:

1. Never stand in the bight of a line or in the direct line of pull when the line is being pulled or under tension. See figure 3-2 for an example of bight areas.

2. Never continue to increase the load on a line after the rigs have been two-blocked or tightened. Many injuries and fatalities have occurred when operators have not observed this rule.

3. Remember: A safety observer is a must in every case where lines are being worked.

Before using new three-strand synthetic fiber line, it should be faked down on deck and allowed to relax for 24 hours. The shorter the line, the less time the relaxing process takes; for example, a length of less than 50 feet will relax in 1 hour.

When wet, synthetic line shrinks slightly but does not swell or stiffen. When the line is tensioned, the water squeezes out; and under working loads, it appears as vapor. Because line under tension develops friction and, thus, heat, the water has a beneficial cooling effect.

Nylon differs from natural fiber line in that it stretches under load, yet recovers to its normal size when tension is removed. With plain-laid and cable-laid nylon, a stretch of one-third of its length is normal under safe working loads. A stretch of 40-percent of its length is the critical point, and it parts at 50-percent stretch. With double braided nylon, the critical point is reached when the line is stretched 27 percent; it parts when the stretch is 30 percent. This elongation at times may be a disadvantage, but it can be reduced by doubling up the lines by passing bight. Nylon line can stand repeated stretching with no serious effect.

Sharp, cracking noises, caused by readjustment of the strands, are heard when applying a load to new cable-laid hawsers. Nylon line that has been under

heavy strain may develop glazed areas where it has worked against bitt and chock surfaces. This condition may be caused by paint or the fusing of the fibers. In either condition, the effect on the line's strength is negligible.

New cable-laid nylon hawsers tend to be stiff and difficult to handle. To alleviate this condition, put the cables under tension for 20 minutes at 30 percent extension; for example, 100 feet when under tension would measure 130 feet.

Nylon line can hold a load even though a considerable number of the yarns become abraded. Where such a condition is excessive but localized, the chafed section may be cut away and the ends spliced together for satisfactory reuse.

When nylon lines become iced over in use, they should be thawed carefully at moderate temperatures and drained before stowing.

If a nylon line becomes slippery from contact with oil or grease, it should be scrubbed down. Spots may be removed by cleaning with light oils such as kerosene or diesel oil.

Do not stow nylon line in strong sunlight. Cover it with paulins. In stowage, keep it away from heat and strong chemicals.

Synthetic lines under stress are far more dangerous than natural fiber lines. Remember synthetic line, unlike natural fiber line, will not give you an audible warning that it is under great strain and is in danger of parting. You must rely on visual cues; the line begins to smoke because of the heat generated by stretching, the line diameter will get smaller and smaller as stretching continues, and finally the tattletale cord will lay taut against the line. A *tattletale cord* is a bight of six-thread manila hanging from two measured points on the working line. When tensioned to its safe working load (SWL), the line will stretch to a certain percentage of its length. When this point is reached, the six thread becomes taut, warning that there is danger of exceeding the line's SWL. Table 3-1 shows the dimensions for tattletale lines.

NATURAL FIBER LINES

LEARNING OBJECTIVES: Describe natural fiber lines. Describe the characteristics of natural fiber lines.

When you have a new coil of natural fiber line to open, remember that if you open it backwards, or from the wrong end, you will have a kink for every turn in the coil. Every kink must be unwound by walking it out the

entire length of the line. When you start to walk out a kink from the middle, you turn into the next kink and the next, until the line is one large tangle.

The end of a new coil to be drawn out first is marked with a tag. Occasionally, it is tagged on the wrong end. The only way you can be sure that you are opening a coil properly is to know how to do it. The inside of every new coil is in the form of a round tunnel. At one end of the tunnel is the inside end of the line. This inside end always comes out first, usually from the bottom of the tunnel up through the tunnel. Reach through the tunnel until you find the end, and determine on which end to set the coil so the line will uncoil in a counterclockwise direction. Reach in, draw the end up through the tunnel, and the entire coil will run off without a kink. The important point to bear in mind is that when you pull on the inside end, the line must uncoil in a counterclockwise direction.

STRENGTHS

Until the development of synthetics, manila was the strongest line. It also was the most expensive. It was natural to compare other ropes with manila, and it still is convenient to do so. The following table gives the comparative strengths of the various lines using manila as a base strength of 1. (All synthetics are stronger than manila.)

Rope Type	Strength Rating
Aramid (four-strand)	5.6
Nylon (three-strand)	2.9
Polyester (three strand)	2.4
Polypropylene	1.7

MEASURING

When you are sent to the Bos'n locker for 5 fathoms of line, you need not measure off exactly 360 inches with a tape measure. Your two arms, spread as wide apart as possible, will equal approximately 1 fathom (6 feet). With the end of the line in one hand, spread your arms, grab the line where your other hand reaches, and change hands until you have spread your arms five times.

In measuring a long line, such as a boat fall, it is much easier and faster to measure a long stretch on deck and fake your line back and forth until the desired length is laid out.

Table 3-1.—Dimensions for Tattletale Lines

Type of Synthetic Rope	Length of Tattletale (inches)	Distance Between Marks (inches)
Nylon three-strand	35 1/2	30
Nylon plaited	43 1/2	40
Nylon double-braided	43 1/2	40
Polyester three-strand	63 1/2	60
Polyester plaited	62 1/2	60
Polyester double-braided	62	60

MAKING UP A LINE

LEARNING OBJECTIVE: Identify the proper procedures for making up a line.

Once line is removed from the manufacturer's coil, it may be made up either by winding on a reel or by coiling down, faking down, or flemishing.

Coiling down a line means laying it up in circles, roughly one on top of the other. Always coil right-laid line right-handed, or clockwise. Figure 3-3 shows you how to coil a right-laid line. When a line is coiled, one end is ready to run off. This end went down last and now it is on top.) If you try to walk away with the bottom end, a foul-up results. If, for some reason, the

bottom end must go out first, you must upset your entire coil to free it for running.

Faking down a line (fig. 3-4) is laying it out in long, flat bights, one alongside the other, instead of in round coils. The main advantage of working with line that is faked is that it runs off more easily.

Flemishing a line is starting with the bitter end and laying successive circles on the deck of line in the manner of a clock spring with the bitter end in the center



Figure 3-3.—Coiling down a line. 80.21



Figure 3-4.—Faking down a line. 80.22

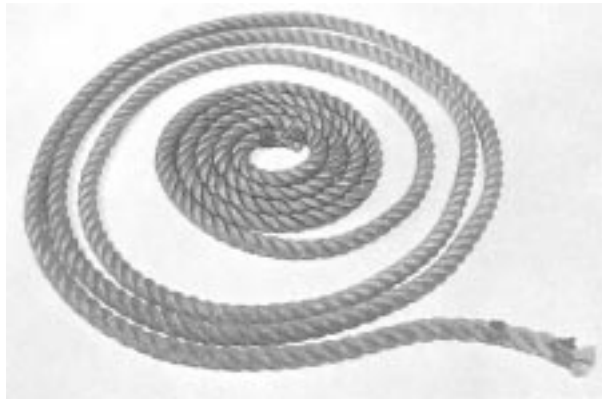

80.23

Figure 3-5.—Partially flemished line.

(fig. 3-5). Right-laid line is laid down clockwise; left-laid line, counterclockwise.

SECURING ENDS

LEARNING OBJECTIVE: Explain the procedures for securing ends of lines. Identify the difference between a temporary whipping and a permanent whipping of a line.

Never leave the end of a line dangling loose without a whipping to prevent it from unlaying. The end of line will begin to unlay of its own accord. To prevent fraying, you should put a temporary plain whipping on with anything, even a rope yarn, as shown in figure 3-6.

Lay the end of the whipping along the line and bind it down with a couple of turns. Then lay the other end on the opposite way, bind it with a couple of turns from the bight of the whipping, and pull your end tight.

A permanent whipping is put on with a palm and needle (see the section on Seaman's Tools in this chapter). Thread a needle with sail twine, double it (figure 3-7 shows single twine for clearness only), and shove it through the middle of a strand so it comes out between two strands on the other side. Bind the end down with six or eight turns wound on from inboard toward the end, and again shove the needle through the middle of a strand near the end so it comes out between two strands again. Then go up and down between strands so as to place a cross-seizing between each pair, as in figure 3-7.

Pull each cross-seizing taut before taking the next one, and have the needle come out through the middle of a strand on the last shove through, so the strand will hold the end after you cut the sail. Remember, you must wind the turns of whipping from the line toward the end; otherwise, the needle will come out at the wrong side of the whipping after you make the final cross-seizing. When you cut a line, it is best to put on the whipping before cutting the line. Ends of small stuff can be laid up with a palm and needle whipping.

Several pieces of ropework start from a crown knot, so now is the best time for you to learn to tie a crown. Figure 3-8 diagrams the steps in making one. After you haul down the crown taut by heaving on each of the

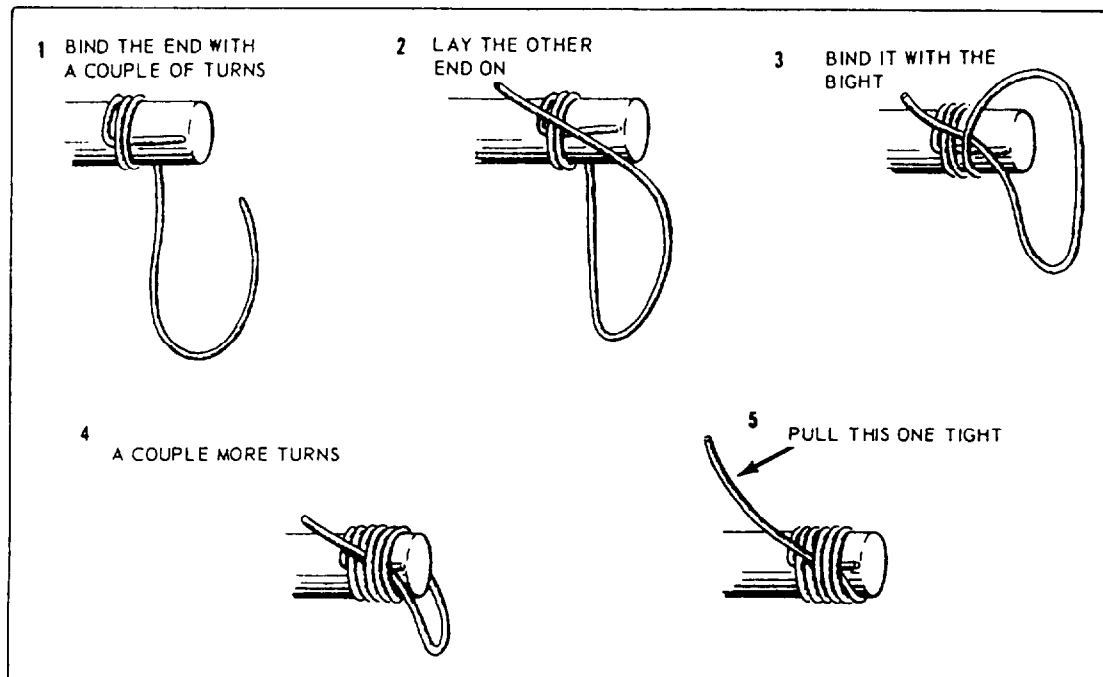

Figure 3-6.—Plain whipping a line.

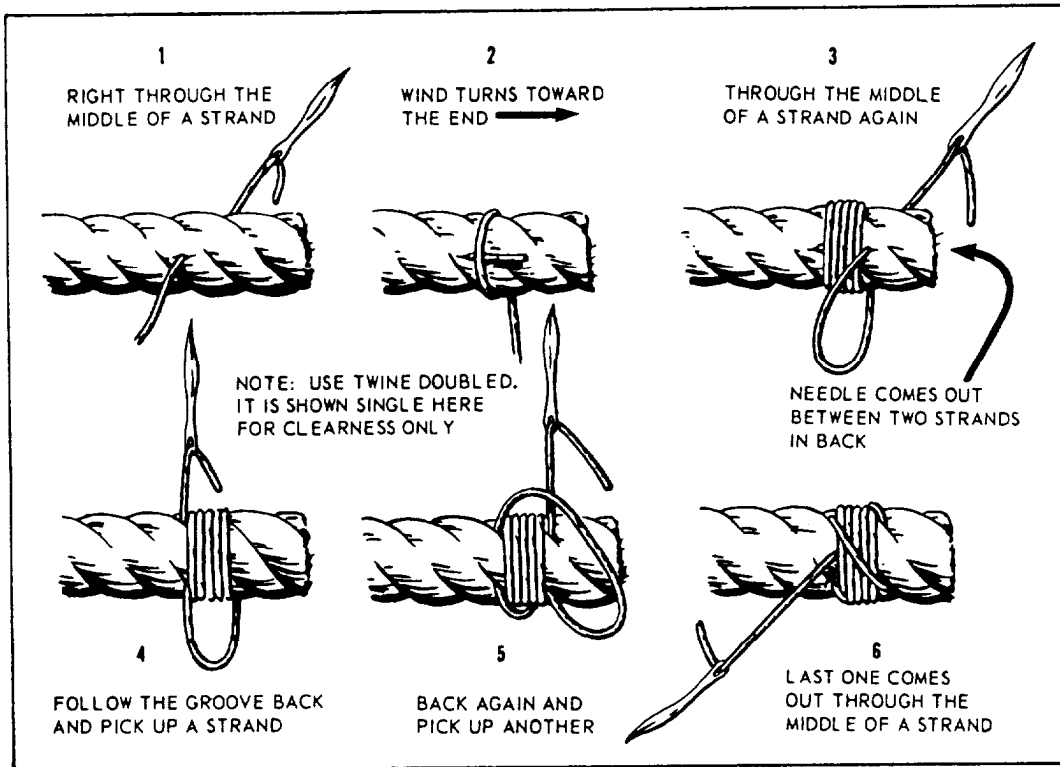

Figure 3-7.—Palm and needle whipping.

three strands, lay up your backsplice by merely tucking each strand back up the line, over and under, as described later for the eye splice. Throw a whipping on any line you see dangling loose, and make up any slack ends of lines not made up properly or hanging adrift. Always take care of the end.

Frequently, it is necessary to put on inside turns (fig. 3-9) when a fairlead does not line up properly with a winch drum. You must put on turns by pulling back slack and winding your turns on backwards (as shown), from inboard to outboard on the winch drum because you cannot get hold of the end.

FAIRLEADS, KINKS, AND TWISTS

LEARNING OBJECTIVE: Determine the proper method for rigging fairlead blocks.

If a line does not lead fairly to a winch or capstan, it becomes badly distorted when it is heaved in.

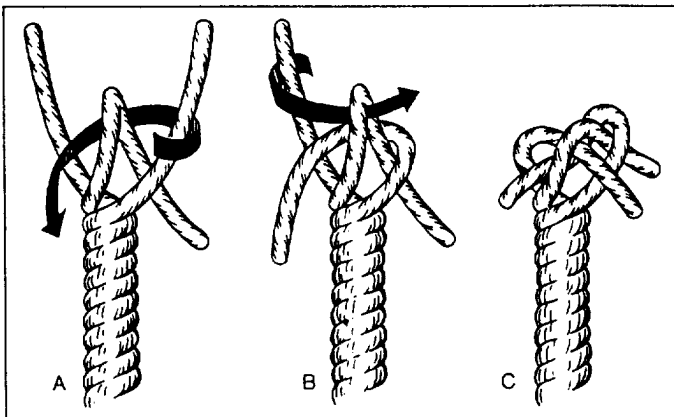

Figure 3-8.—Steps in making a crown.

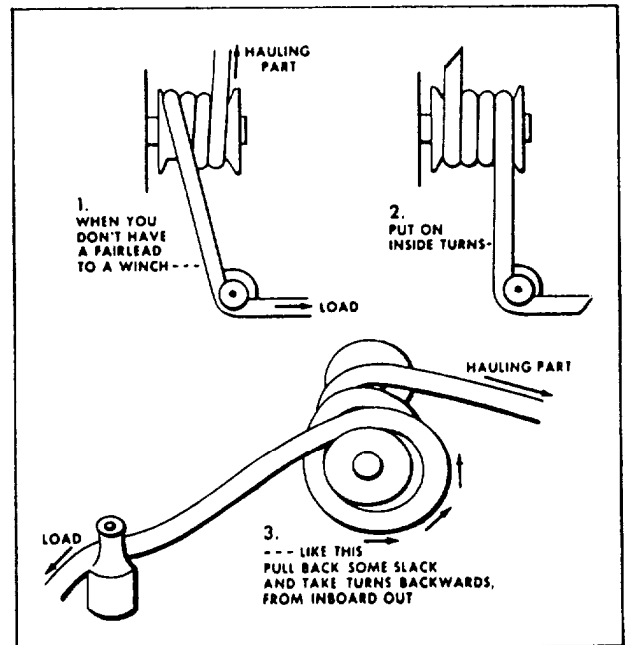

Figure 3-9.—Putting on inside turns to get a fairlead.

Whenever possible, a right-laid line should be put on a winch drum or capstan right-handed, or in clockwise turns. Heaving on a right-laid line with left-handed turns eventually creates kinks in the line.

A line with a kink in it, or a tackle that is twisted from having a dip in it, should never be heaved hard while that condition exists. A strong strain on a kinked or twisted line puts a permanent distortion in the line.

Figure 3-10 shows what frequently happens when a line with a kink in it is heaved hard. Now the original kink has been forced into each strand. It is impossible to work out the kink; hence, the line is ruined.

Deterioration of natural fiber line through age or exposure is indicated by the gradual change in its color from a yellowish white to a gray.

Deterioration from use or abuse is shown by the bristling of the ends of broken yarns. An overstrained line also shows a decrease in diameter. An individual should never be sent aloft or over the side on such a line.

If the identification marker tape indicates the natural fiber rope is 5 years old, it should not be used for critical operations or those involving the lives of personnel.

SEAMAN'S TOOLS

LEARNING OBJECTIVE: Recognize and describe the most common tools used by Seamen.

There are many tools used by a deck Seaman. We only discuss a few of them in this chapter. To find out more about the tools used in painting, you should refer to *Boatswain's Mate, Volume 1*, NAVEDTRA 10101. We discuss the Seaman's knife, marlinespikes, and fids first. We address the sail needles and the sail palms in the canvas section of this chapter.

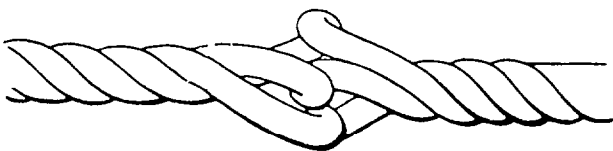

Figure 3-10.—Result of a strong strain on a line with a kink in it.

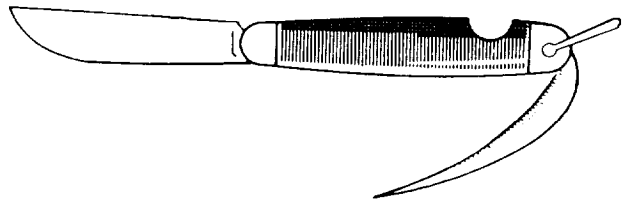

Figure 3-11.—Best type of knife for a Seaman.

Figure 3-11 shows the best type of knife for working with line. This knife is available almost anywhere ashore. Its blade has a straight cutting edge rather than a curved one. The small spike on the knife is convenient for opening shackles, and it is indispensable for drawing up close knots like monkey fists, manrope knots, and Turk's heads.

The wooden fid is a long, tapered tool used for opening strands in line for splicing. Never use it for anything else, and never hammer the butt end of a fid to drive it through. It splits or splinters very easily. To open heavy line, set the butt of the fid on deck and hammer the line onto the point. Never call a fid a marlinespike.

The marlinespike, a tapered steel tool, serves the same purpose with wire that the fid does with line. A good spike should never be used as a crowbar or a pin to open shackles, and care must be taken to avoid bending or blunting its point. Unlike the fid, you can hammer the butt of a marlinespike.

KNOTS

LEARNING OBJECTIVES: Define the types of knots used in a line. Identify the knots used to form a loop or an eye. Explain bending to a hook, ring, or spar.

Learning the proper methods of handling and applying knots and splices, and practicing them, are an essential part of your job as a Seaman apprentice.

Among Seamen the term *knot* must give way to its more specific meanings: *bend* and *hitch*. In addition, Seamen must know which knot, bend, or hitch will serve best in a particular circumstance.

First and foremost, a good knot must hold fast without slipping. Next, if it is a knot in general use and not an ornament, it should be easy to tie. The best knot is one that possesses all these advantages and is easy to untie as well.

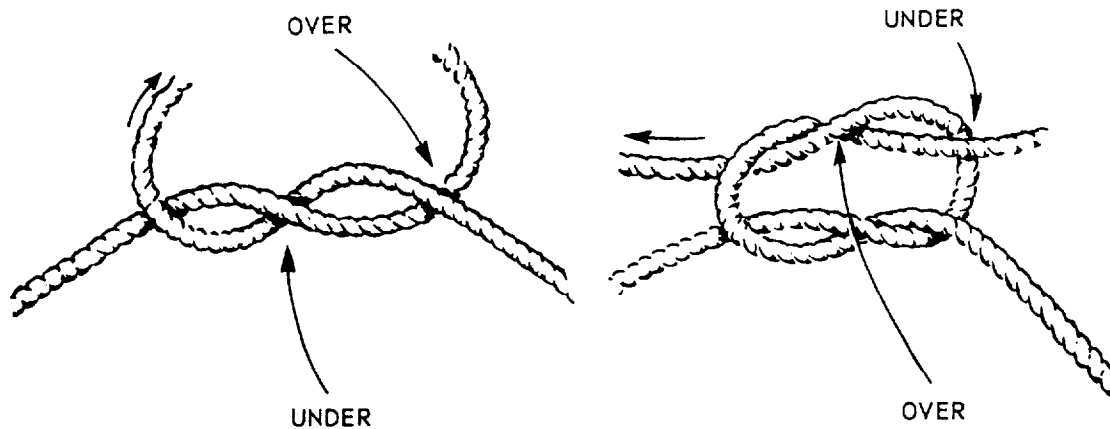

Figure 3-12.--Square knot.

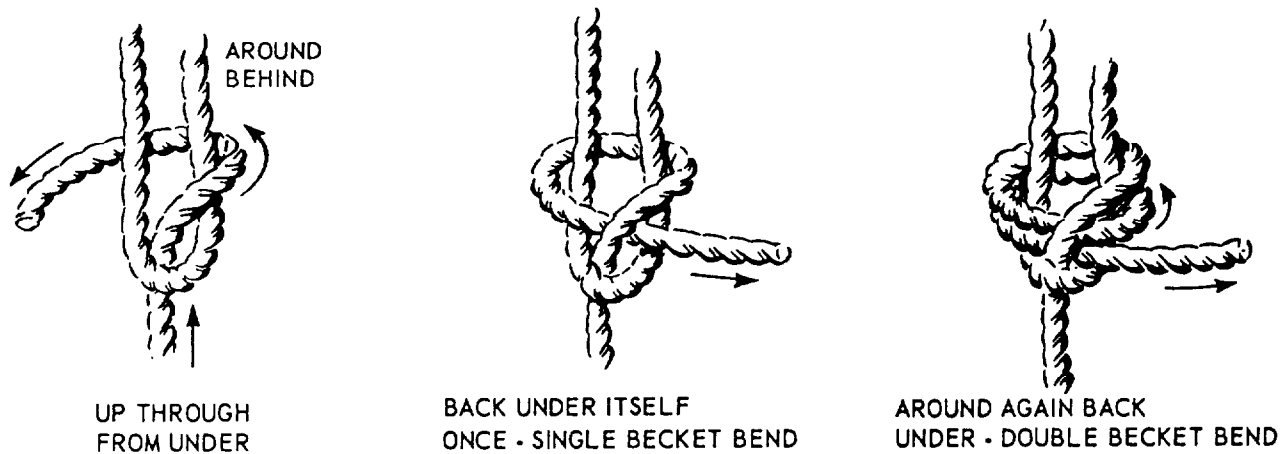

Figure 3-13.--Tying single and double becket bends.

The bowline is a good knot with many uses. It is used whenever a loop is needed, such as in making a temporary eye in a mooring line.

You must know which knot or splice will serve best in different circumstances such as tying up to a mooring or dock, rigging aloft or over the side during painting, and highline transfer during replenishment.

In the small group of knots described in this section, you will find every knot you will need around the decks, together with an idea of the uses to which each may be put. You should make every effort to learn them.

According to a Seaman's use of the term knot, the line usually is bent to itself. The knot forms an eye or knob or secures a cord or line around an object, such as a package.

A bend ordinarily is used to join two lines together. The square knot, also called the reef knot, is

the best known knot for bending two lines together. However, it can jam on a strain and become very difficult to untie.

For a square knot, both parts of the line must be under the same bight. If one part is up and the other part is down, you have a granny knot, which is of no use to any seaman. Figure 3-12 shows how to get a square knot every time.

Here is the proper procedure for tying a square knot: Take the end in your right hand, say to yourself, "over-under," and pass it over and under the part in your left hand, as shown. With your right hand take the end that was in your left, say to yourself this time, "under-over," and pass it under and over the part in your left hand.

A becket bend, is especially good for bending together two lines of different sizes. Figure 3-13 details

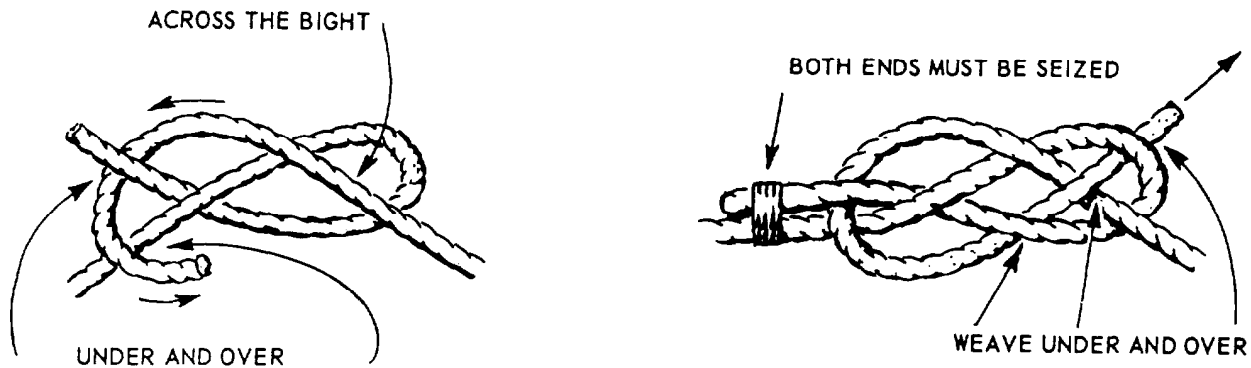

Figure 3-14.—Tying a carrick bend.

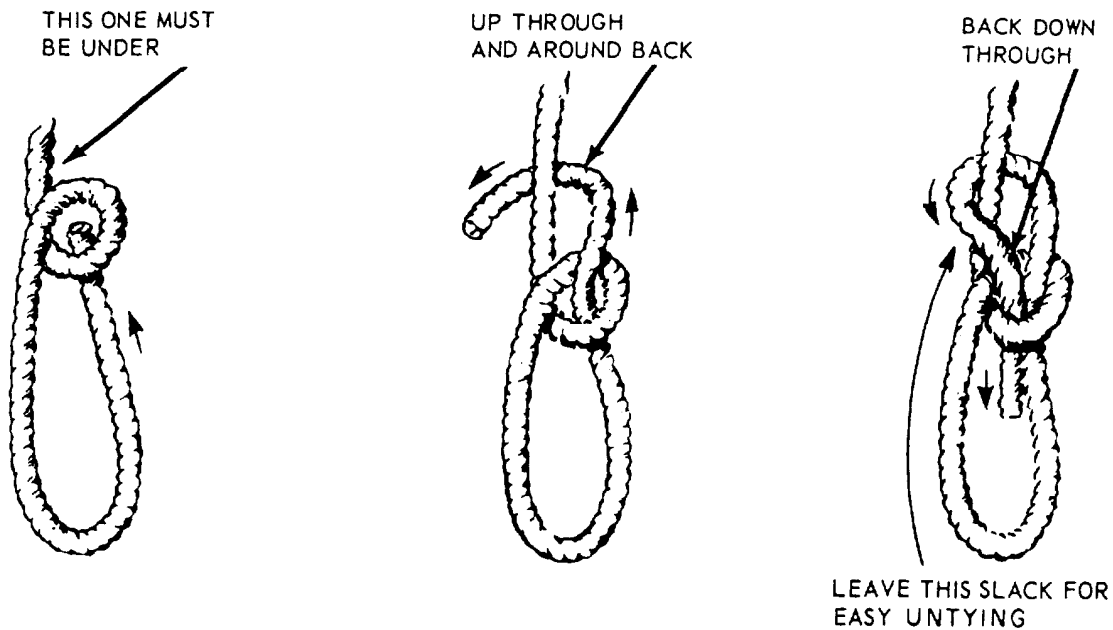

Figure 3-15.—Tying a bowline.

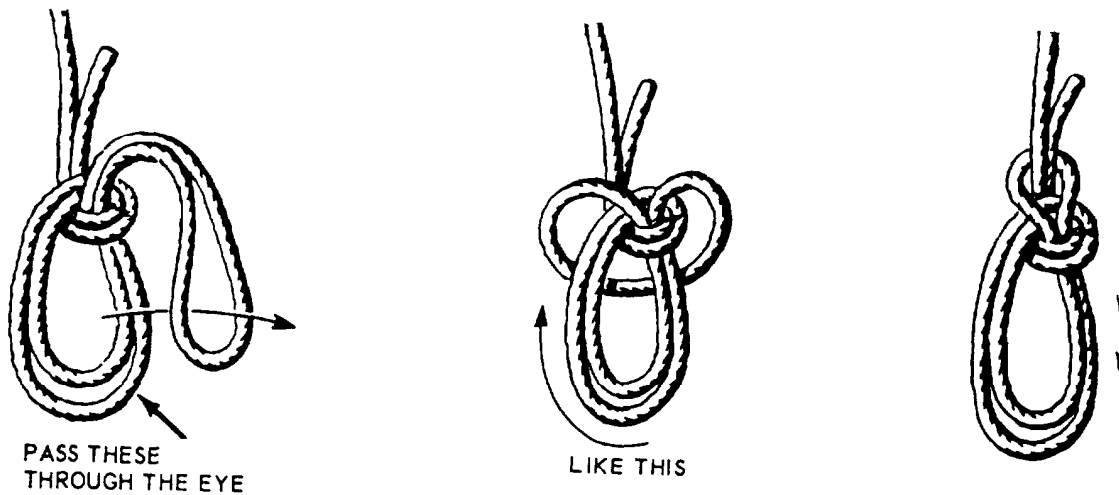

Figure 3-16.—Bowline on a bight.

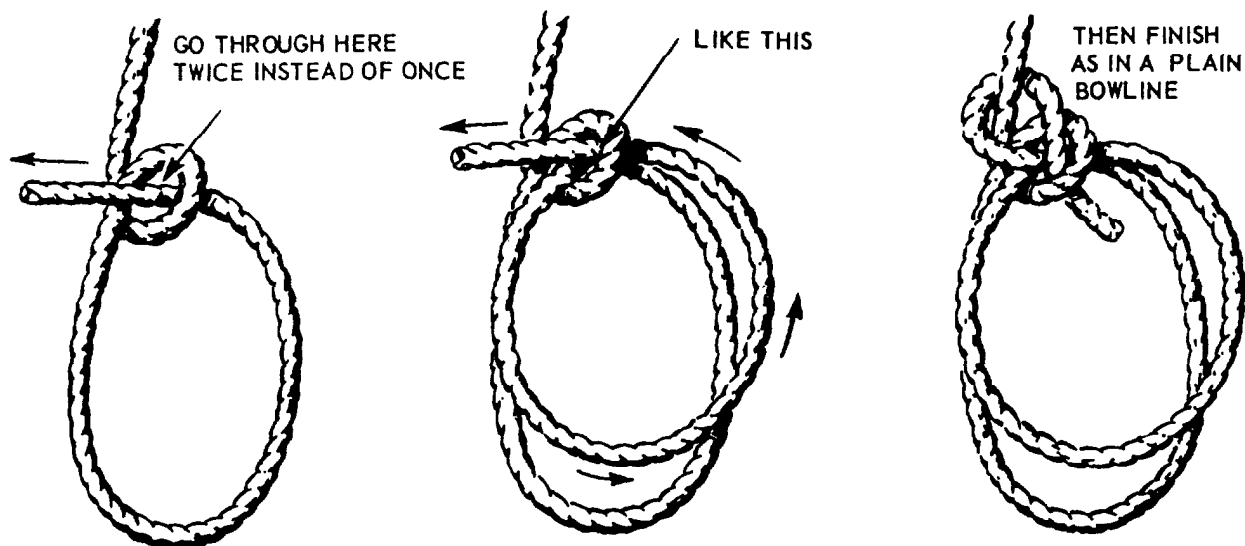

Figure 3-17.—Tying a French bowline.

the steps in tying a single and a double becket bend. A double becket bend is always used to bend the gantline (riding up and down line) onto a boatswain's chair.

The carrick bend (fig. 3-14) is an easy knot formed by two overhand loops crossing each other. It provides a very secure means of fastening two hawsers together, and has the advantage that when drawn taut, it assumes a form that can be passed around a barrel or winch. The ends should be seized down on their standing parts for security.

Another method of quickly bending two lines together is the bowline bend. It is formed of two bowlines one crossing the loop of the other.

KNOTS TO FORM A LOOP OR EYE

The bowline (fig. 3-15) is the standby for putting a loop in the end of a line. It neither slips nor jams, yet unties easily. A bowline is the best knot to use for bending a heaving line or messenger to the eye of a hawser because it is quick to tie and easy to get off.

A bowline on a bight gives two loops instead of one, neither of which slips. It is used to hoist a person, chair-seat fashion, out of a lifeboat or hold. Figure 3-16 shows you how to tie a bowline on a bight. As you can see, you start with your line doubled.

A French bowline has the same purpose as a bowline on a bight. It gives you two loops that can be

adjusted to fit. Adjust one of the loops under both hips, the other under the armpits, and draw the loops tight with the knot at the chest. You can transport an unconscious crew member safely in a properly secured bowline if you take care not to allow the part under the arms to catch on any projections. A step-by-step example of how to make a French bowline is given in figure 3-17.

A running bowline is just regular bowline made around the standing part of its line to form a running noose. Just tie a small bowline around the line's standing part, keeping it slack enough to run freely.

BENDING TO A HOOK, RING, OR SPAR

You can use a hitch to secure a line to a hook, ring or spar. We will describe various hitches in this section.

A hitch differs from a knot in that it ordinarily is tied to a ring, around a spar or stanchion, or around another line. It is not tied back on itself to form an eye or to bend two lines together.

The rolling hitch is one of the most useful and important hitches on deck.

Use it for passing a stopper on a mooring line when shifting the line from a winch or capstan to a cleat or bitts. It may also be used to secure a taut line back on itself. If tied properly, it holds as long as there is a strain on the hitch.

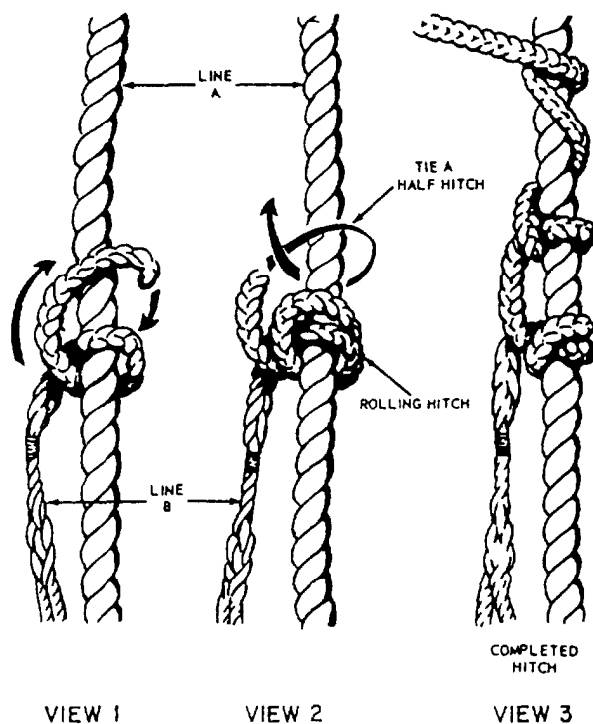

Figure 3-18.—Rolling hitch.

When tying the rolling hitch, take a turn around the line with the stopper as in view 1 of figure 3-18. Pull taut, then take another turn. This turn must cross over the first (view 1) and pass between the first turn and the stopper (view 2). The rolling hitch itself is now complete, but it must be stopped off in one of several ways.

You may take two or more turns with the lay of the line and then marry the stopper to the line by hand or seize the stopper to the line with marline. Another method is to tie a half hitch directly above the rolling

hitch (view 3), then take a couple of turns against the lay, and marry or seize the stopper to the line.

A clove hitch is the best all-round knot for bending to a ring, spar, or anything else that is round or nearly round. This is such a fine knot that the old-time seamen used to call a man who was worth his salt “all in a clove hitch.” Figure 3-19 shows you how to throw one.

A clove hitch will not jam and seldom pulls out. A slack clove hitch, as on a boat painter, however, might work itself out. For that reason, it is a good idea to put a half hitch in the end as in figure 3-20. A half hitch, by the way, never becomes a whole hitch. Put another one on, and all you have is two half hitches, as shown.

The slight disadvantage a clove hitch might have is that it can slide along a slippery spar when the strain is along the spar. The knot that cannot slide this way is the stopper hitch (fig. 3-21). This knot is especially useful for bending a boat painter to a larger line whose end is unavailable. It jams tight on a hard strain, however.

SPLICES

LEARNING OBJECTIVES: Define line splices. Identify the types of splices.

Splices are used to make permanent eyes and permanent repairs in lines. There are three general types of splices: eye, short, and long. When splicing fiber line, you should take three or four tucks with each strand.

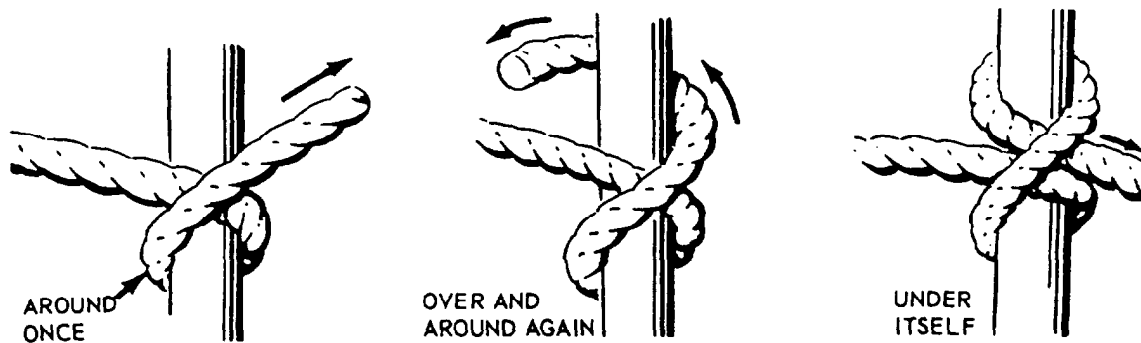

Figure 3-19.—Throwing a clove hitch.

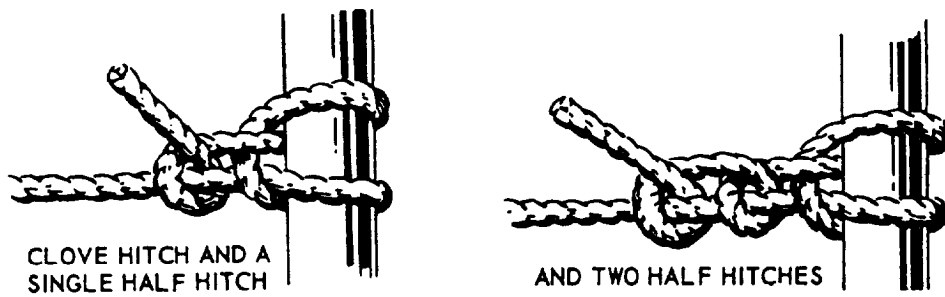

Figure 3-20.—Clove hitch and two half hitches.

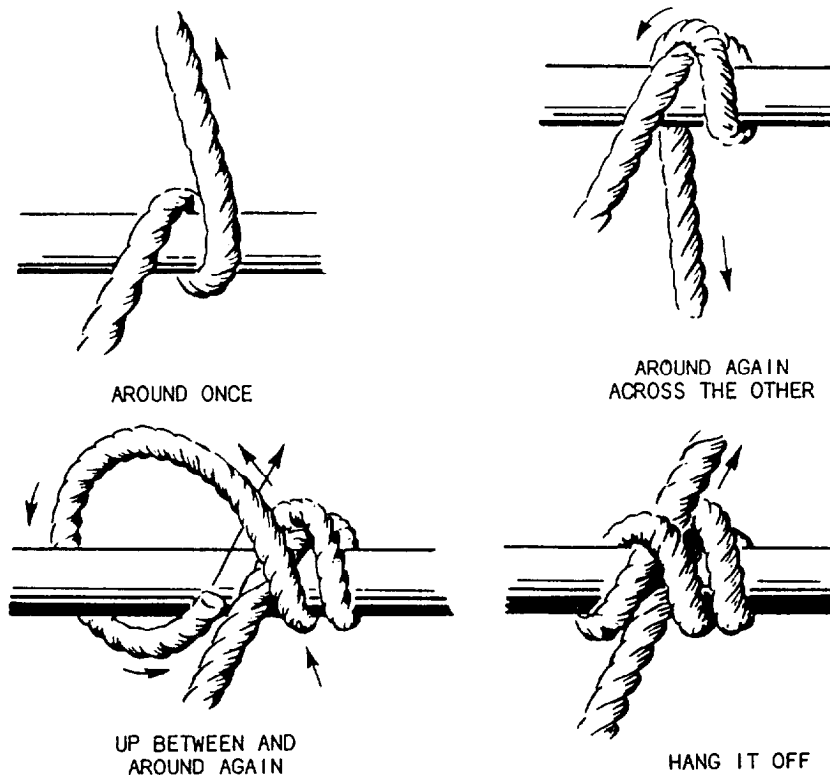

Figure 3-21.—Stopper hitch.

EYE SPLICE

To make an eye splice with manila or synthetic lines, you must untwist the strands in the end of your line anywhere from 4 inches to 2 feet, depending on the size of the line, and splice them into the standing part of the line by tucking the unlaidd strands from the end into the standing part.

Learn to estimate the length of line you need to unlay for your complete splice so you will not finish short nor waste a lot of line by cutting it off. An original round of tucks, plus three more complete rounds, are

enough for an ordinary eye splice. Four tucks are mandatory in nylon because of its low friction and stretch characteristics.

With large lines you must whip the ends of the strands before you start, otherwise they will unravel and become troublesome. Large lines also must be seized at the point where the unlaying stops or you will have trouble working them. With any line up to about 2 inches, you can open the strands in the standing part with your fingers. The fid must be used for larger lines.

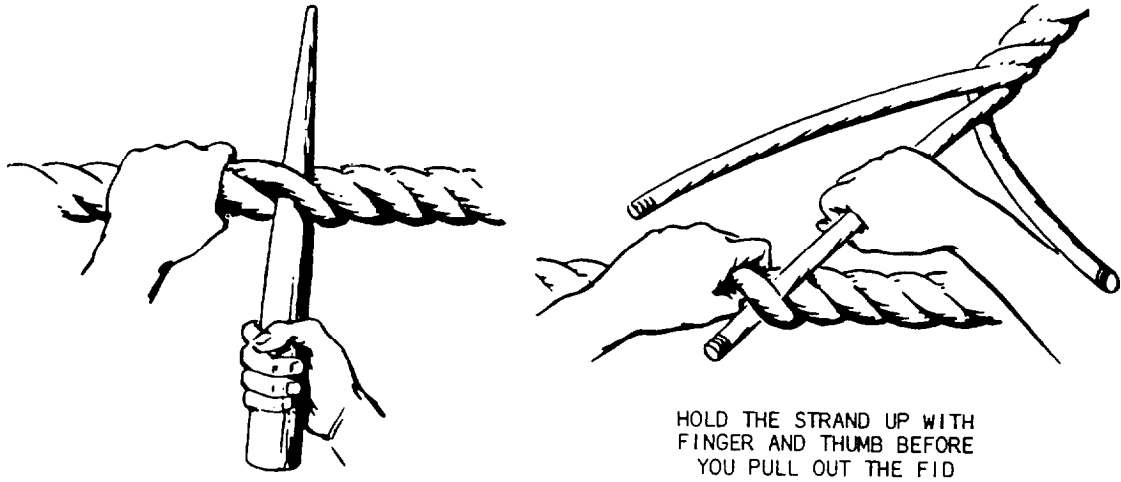

Figure 3-22.—Working the fid.

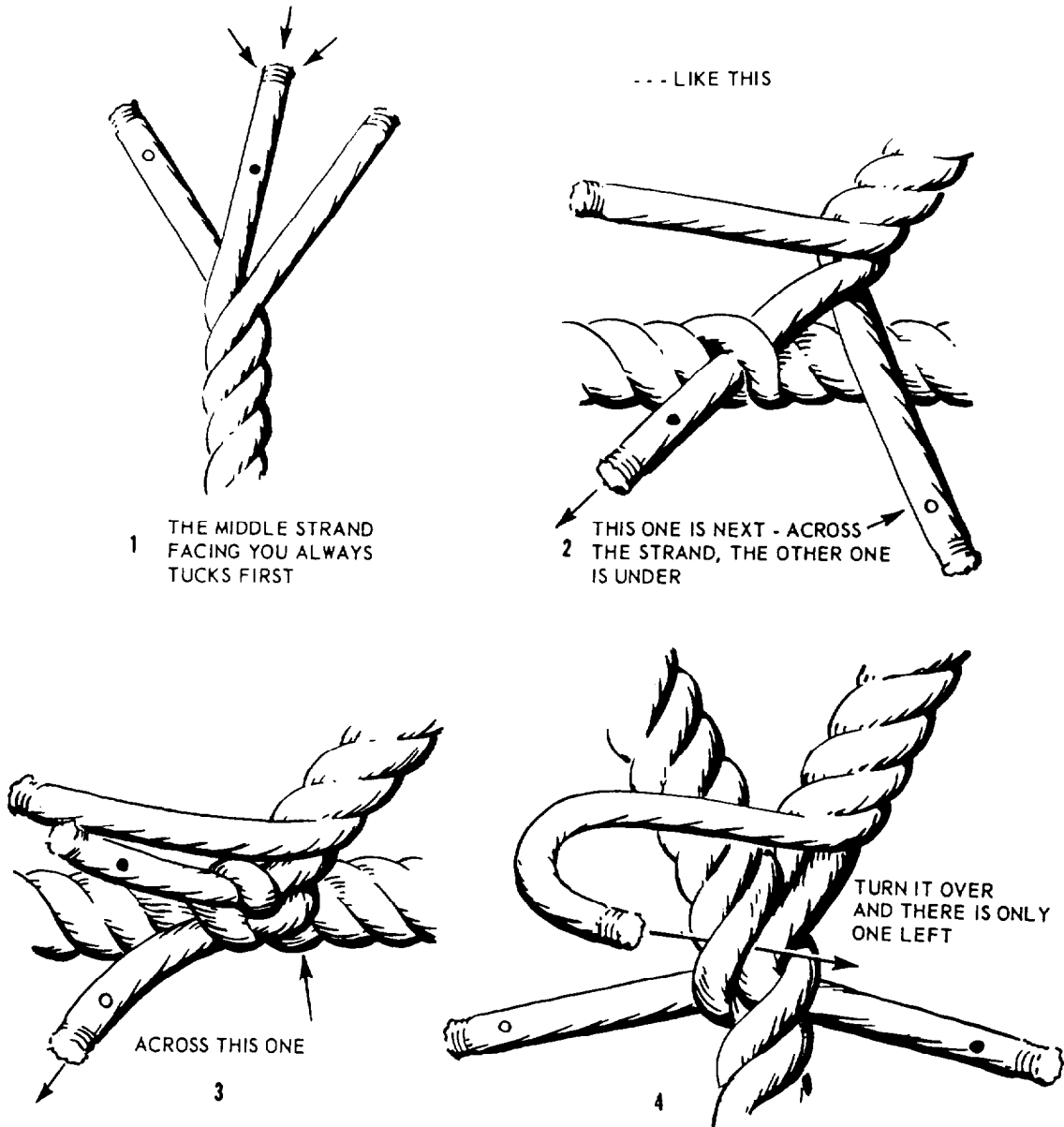

Figure 3-23.—Making an eye splice.

Figure 3-22 shows the knack of working the fid in making an eye splice. Lay out your line along the deck with the end to your right. Bend the line back until the eye is the desired size, and shove the fid through the standing part at the correct spot to raise the top strand. With your right hand shove the fid through, away from you, holding the line with your left hand. Grab the raised strand with your left finger and thumb, and hold it up while you pull out the fid. Lay the fid down, pick up the proper strand in the end, and tuck it through the raised strand from outboard toward you.

Your first round of tucks must be taken in proper order to avoid getting fouled up. Separate the strands in the end and hold them up as indicated in view 1 in figure 3-23. The middle strand (facing you) always tucks first. Be sure to keep the right-hand strand, shown in view 2, on the side of the line that is toward you. Tuck that one next, over the strand you just tucked the other one under, and under the strand just below it, shown in view 3.

Now turn the whole thing over. In view 4, you can see that you now have only one strand from the end left untucked, and only one strand in the standing part that does not already have a strand under it. Do not forget to tuck the last strand from outboard toward you.

The first round of tucks is the key to making perfect eye splices; the rest is easy. Simply tuck each strand from the end over the strand of the standing part that it is now above, and under the next strand below that one, until you tuck each strand twice more besides the

original tuck. Three tucks to each strand in all is enough for natural fiber rope. Four or five tucks are needed for synthetic fiber, especially the more slippery nylon.

SHORT SPLICE

Lines are short spliced together when a slight enlargement of the diameter of the line is of no importance. Slings are made of pieces of line, with their own ends short spliced together.

The only trick to short splicing is in seizing the ends together (fig. 3-24) so each strand in one end lies along a corresponding strand in the other end. After unlaying the strands, you simply butt the two ends against each other until you see that they are interlaced correctly.

With large lines you now must put on a temporary seizing where they join to keep them from suddenly coming apart. It is better to do that with small lines, too, until you get the hang of holding them together while you tuck.

Once your seizing is on, tuck over and under the same way you finish off an eye splice. Three tucks on each side of the seizing are sufficient.

SAILMAKER'S SPLICE FOR FOUR-STRAND ROPE

An eye splice consists of three main components, the eye, individual strands, and the standing part of the rope. The eyes in mooring lines are normally 6 to 10 feet

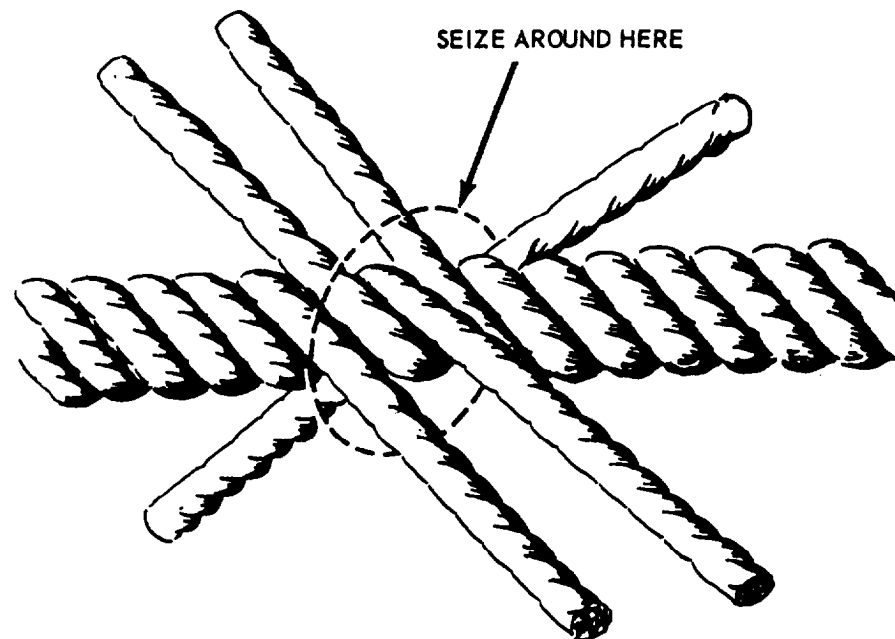

Figure 3-24.—Seizing lines for splicing.

in length, depending on the size fitting used. The rule of thumb for preferred length of the eye is 5 times the diameter of the fitting. This prevent uneven loading of the eye. The following is the procedure for splicing four-strand rope:

1. Measure a distance of seven times the rope circumference from the end of the rope and mark using a temporary whipping. Determine the eye size and form a loop which places the first whipping on the standing part at the end of the eye and mark with a second temporary whipping.

2. Unlay the strands of the rope to the first whipping and cut out the center core. Looking in the direction of the standing part, tuck the first strand under the top strand of the standing part from left to right with the lay at the base of the second whipping.

3. Tuck the second strand under the next strand of the standing part with the lay. Tuck the third strand under the next strand of the standing part with the lay.

4. Turn the rope over and tuck the fourth strand under the last strand of the standing part of the lay.

5. This constitutes one full tuck. Ensure all working strands are pulled tight and free of twists.

6. Continue tucking all four strands in succession over and under the strands of the standing part for a total of six tucks.

7. Using a light strain, set the splice.

8. Marry the working strands using an inside whipping under the strands of the standing part at the last full tuck.

9. Cut the remaining working strands off flush with the rope.

NOTE

The last two tucks may be tapered, if desired, by cutting approximately half of the fibers for each taper. Chafing gear on the eye is required for abrasion.

WIRE ROPE

LEARNING OBJECTIVE: Describe the construction, use, and care of wire rope.

Although wire rope may have only a few applications in some Navy ships, in others, wire rope is

very important. It behooves all seamen to learn all they can about wire rope.

CONSTRUCTION OF WIRE ROPE

The basic unit of wire-rope construction is the individual wire made of steel or other metal in various sizes. These wires are laid together to form strands. The number of wires in a strand varies according to the purpose for which the rope is intended. A number of strands are laid together to form the wire rope itself. Wire rope is designated by the number of strands per rope and the number of wires per strand. Thus, a 6 X 19 rope has 6 strands with 19 wires per strand, but has the same outside diameter as a 6 X 37 wire rope, which has 6 strands with 37 wires of much smaller size per strand. Wire rope made up of a large number of small wires is flexible, but the small wires break so easily that the wire rope is not resistant to external abrasion. Wire rope made up of a smaller number of larger wires is more resistant to external abrasion, but is less flexible.

The strands of the wire rope are laid up around a central core, which may be fiber, a single strand of wire, or an independent wire rope. A fiber core contributes flexibility, cushions the strands as the wire rope contracts under strain, and holds a portion of lubricant for continuous lubrication. A wire core is stronger than a fiber core and can be used where conditions such as high temperatures would damage the fiber. Some end views of the arrangements of strands in wire ropes are shown in figure 3-25.

Wire rope may be fabricated by either of two methods. If the strands of wires are shaped to conform to the curvature of the finished rope before their laying up, the wire rope is termed *preformed*. If the strands are not shaped before fabrication, the wire rope is termed *non-preformed*. When cut, preformed wire rope tends not to untwist and is more flexible than other wire rope.

Wire rope is made of annealed steel, traction steel, or improved plow steel. The basic metal may be plain or galvanized. Galvanizing protects the rope from the elements, but makes it stiffer and reduces its strength by as much as 10 percent. Galvanized rope most commonly is used for standing rigging, but also is used for some running rigging (such as wheel ropes) where it is not subject to much wear. Ordinarily, this rope is not used for hoisting jobs because the constant bending and flexing as the rope runs over the sheaves and around drums causes the protective coating to crack and peel off.

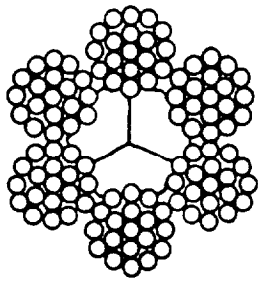

6 STRANDS OF 19
WIRES (6X19)

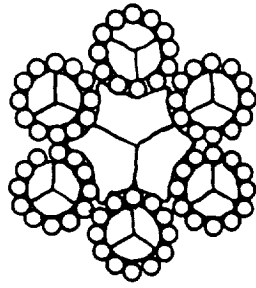

6 STRANDS OF 12
WIRES (6X12)

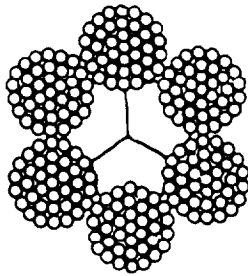

6 STRANDS OF 37
WIRES (6X37)

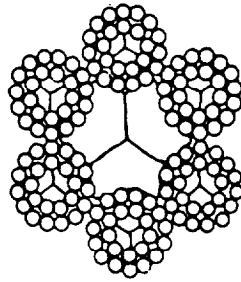

6 STRANDS OF 24
WIRES (6X24)

Figure 3-25.—Arrangement of strands in wire rope.

As shown in figure 3-26, wire rope is laid up in various ways:

RIGHT REGULAR LAY: Wires in the strands are twisted to the left; strands in the rope are twisted to the right.

LEFT REGULAR LAY: Wires in the strands are twisted to the right; strands are twisted to the left.



RIGHT REGULAR LAY



LEFT REGULAR LAY



RIGHT LANG LAY



LEFT LANG LAY



REVERSE LAY

Figure 3-26.—Lays of wire rope.

RIGHT LANG LAY: Both wires in the strands and strands in the rope are twisted to the right.

LEFT LANG LAY: Both wires in the strands and strands in the rope are twisted to the left.

USES OF WIRE ROPE

Chapter 613 of the *Naval Ships' Technical Manual* specifies the uses that may be made of wire rope of various constructions. A few of the more common constructions and some of their uses follow:

6 X 7: Only the galvanized type is specified. It is not suitable for general hoisting, but is applicable for permanent standing rigging.

6 X 19: Size for size, this type of construction is the strongest of all the wire ropes. When made of galvanized wire, 6 X 19 is used principally for heavy hoisting and is particularly useful on derricks and dredges. Standing rigging, guys, boat slings, and topping lifts for booms are often made of galvanized 6 X 19 wire rope. Phosphor bronze 6 X 19 rope is used for lifelines, wheel ropes, radio antennas, antenna downloads, and so forth, where either noncorrosive or nonmagnetic properties are desirable.

6 X 37: When made of ungalvanized steel wire, this construction is flexible, making it suitable for cranes and similar machinery. It may be used for heavy hoisting. For instance, hoisting ropes larger than 1 3/4 inches in diameter usually are of this type. When made of galvanized steel wire, this wire rope may be used for steering gear, boat crane falls, towing hawsers, bridles, torpedo slings, and heavy running rigging.

CARE OF WIRE ROPE

Long lengths of wire rope are usually on reels when received from your supply activity. Never try to unreel wire rope from a stationary reel. Mount the reel on a pipe or rod supported by two uprights. This method allows the reel to turn as the wire rope is pulled. Unreeling presents no problem, but spooling the wire rope back onto the reel may give you some trouble unless you remember that it tends to roll in the opposite direction from the lay. For example, a right-laid wire rope tends to roll to the left. Consequently, start a right-laid wire rope at the left and work toward the right when spooling over the top of the reel. When spooling under the reel, start at the right and work toward the left. Naturally, handle left-laid wire rope just the opposite.

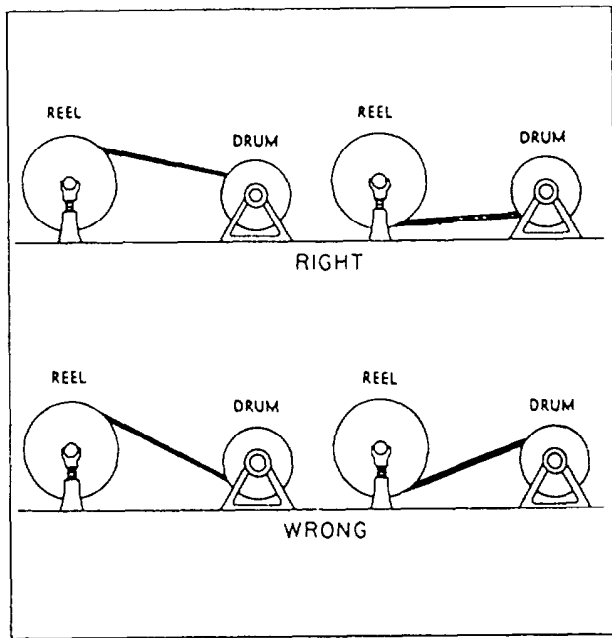

Figure 3-27.—Spooling wire rope from reel to drum.

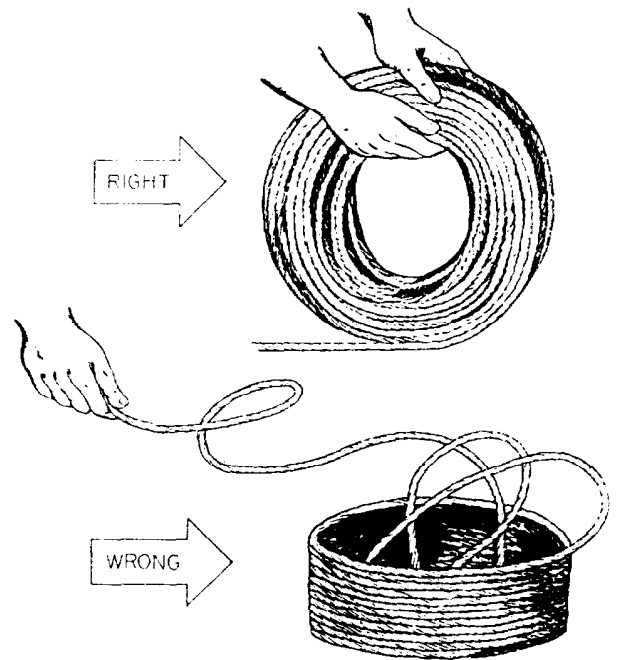

Figure 3-28.—Right and wrong way to uncoil wire rope.

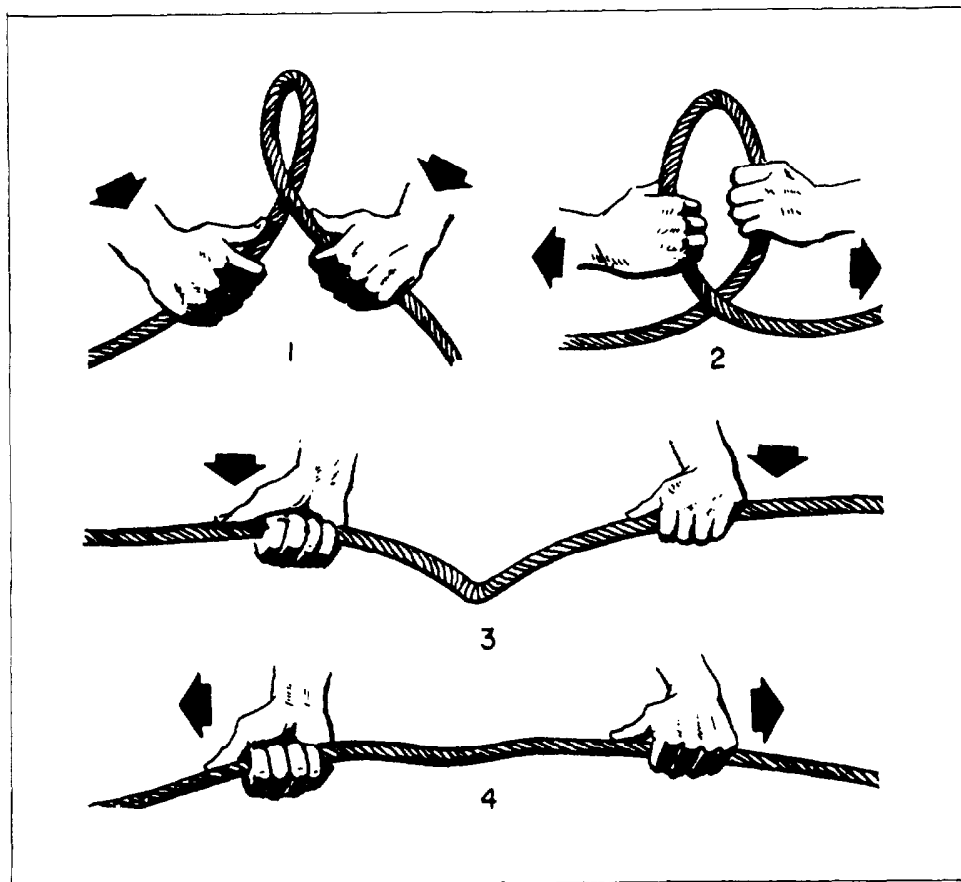

Figure 3-29.—Correct way to take out a kink in wire rope.

If wire rope is being run off one reel to a winch drum or another reel, run it from top to top or from bottom to bottom, as shown in figure 3-27.

Make up short lengths of wire rope in coils and stop off tightly for stowage. When uncoiling wire rope, stand the coil on edge and roll along the deck, uncoiling as you go, as in figure 3-28.

Whenever possible, drums, sheaves, and blocks used with wire rope should be placed so as to avoid reverse or S-shaped bends. Reverse bends cause an unnecessary amount of shifting of the individual wire strands, increasing wear and fatigue. Where a reverse bend is needed, the blocks and drums effecting the reversal should be of larger diameter than ordinarily used and should be spaced as far apart as possible.

If a wire rope becomes kinked, never try to pull it out by putting a strain on either part. As soon as a kink is noticed, uncross the ends by pushing them apart. See step 2 in figure 3-29. Performing these steps reverses the process that started the kink. Now turn the bent portion over and place it on your knee or some firm object and push downward until the kink straightens out somewhat. Then lay it on a flat surface and pound it smooth with a wooden mallet.

If a heavy strain is put on a wire rope with a kink in it, the rope no longer can be trusted. Cut out the kinked part and splice the ends together.

Frequently, abrasion or reverse or sharp bends cause individual wires to break and bend back. These broken wires are known as fishhooks.

Wire rope should be inspected frequently, checking for fishhooks, kinks, and worn and corroded spots. Worn spots show up as shiny flattened surfaces. To determine the wear, you must know (1) the original diameter of the wire rope, (2) the present diameter of the wire rope at the worn place, and (3) the diameter of a single wire in one of the strands of the wire rope. The original diameter of the rope is shown in the ship's allowance list or in the first lieutenant's records. The actual diameter of the rope is found by measuring it with a micrometer or vernier caliper, as shown in figure 3-30.

One or more of the following conditions is sufficient reason for questioning the rope's safety and considering replacement:

1. The normal rope diameter is reduced by more than the amount shown in table 3-2 for the applicable size rope. See figure 3-30 for the correct method of measuring diameter.

2. Six broken wires in one rope lay length, or three broken wires in one strand lay length. See figure 3-30 for definition of a lay length.

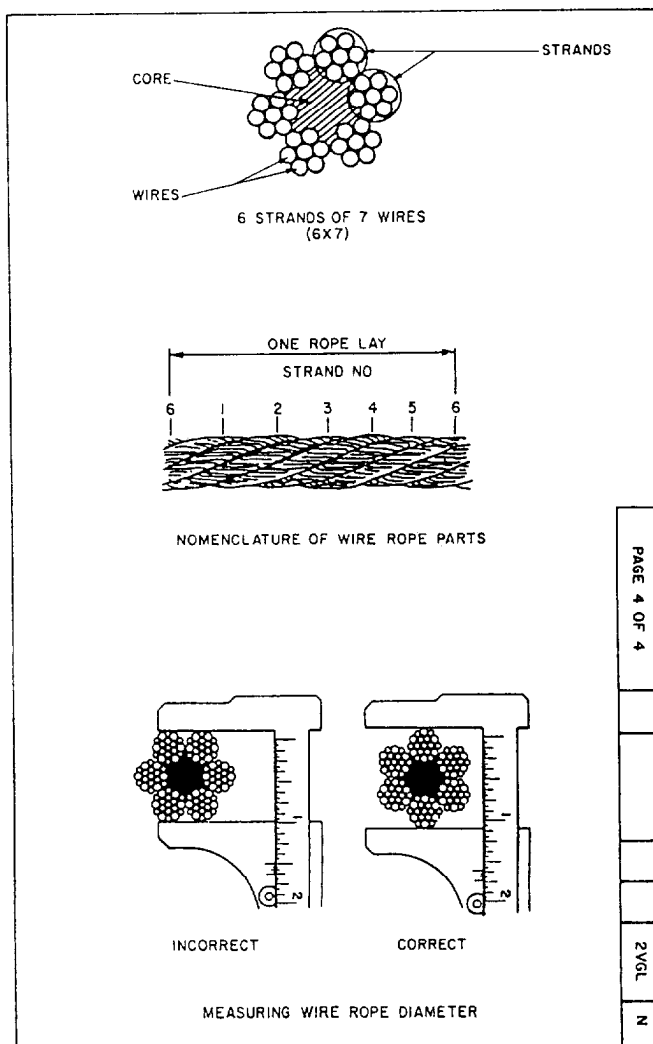

Figure 3-30.—Measuring wire-rope diameter.

Table 3-2.—Wire-Rope Allowable Diameter Reduction

Rope Diameter (inches)	Maximum Allowable Nominal Diameter Reduction (inches)
5/16 and smaller	1/64
3/8 to 1/2	1/32
9/16 to 3/4	3/64
7/8 to 1 1/8	1/16
1 1/4 to 1 1/2	3/32
19/16 to 2	1/8
2 1/8 to 2 1/2	5/32

3. One broken wire within one rope lay length of any end fitting.

4. Wear of one-third the original diameter of outside individual wires.

5. Evidence of pitting due to corrosion.

6. Evidence of heat damage from any cause.

7. Kinking, crushing, or any other damage resulting in distortion of the rope structure.

8. Evidence of internal corrosion, broken wires on the underside of strands, excessive nicks, or core failure.

Rusting and corrosion of the wires and deterioration of the fiber core sharply decrease the strength of a rope. It is impossible to estimate accurately the loss in strength from these effects.

STORAGE

Most of the following information comes from chapter 613 of the *Naval Ships' Technical Manual* (NSTM). The NSTM contains instructions for the maintenance, storage, and repair of equipment under the cognizance of the Naval Sea Systems Command. In it you can find valuable information not available elsewhere on the use, care, and upkeep of much of your equipment. Aboard most ships, the chief engineering officer has a set of these books.

Wire rope should not be stored in places where acid is or has been kept. Stress the importance of keeping acid or acid fumes away from wire rope to all hands at all times. The slightest trace of acid coming in contact with wire rope will damage it at that particular spot. Many times wire rope that has given away at one point has been found to be acid damaged.

Before storage, wire rope should always be cleaned and lubricated. If the lubricant film is applied properly and the wire is stored in a dry place, corrosion will be virtually eliminated.

LUBRICATION

It is important to lubricate wire rope because wire is really a mechanical device with many moving parts. Each time a rope bends or straightens, the wires in the strands and the strands in the rope must slide upon each other, so a film of lubricant is needed on each moving part. Another important reason for lubrication is to prevent corrosion of the wires and deterioration of the hemp core.

Clean used wire ropes before you lubricate them. You can clean them using wire brushes, compressed air, super-heated steam, JP-5, or turbine oil MIL-L-17331 (2190). Cleaning removes the foreign material and old lubricant from the valleys between the strands and from the spaces between the outer wires.

WARNING

When cleaning wire rope with JP-5, you must wear safety goggles, gloves, and protective equipment. Work in a well-ventilated area, preferably open air, to reduce the chance of vapor inhalation.

CAUTION

You should never soak wire rope in JP-5, because soaking may remove the lubricants from the inner wire rope and core. You may, however, soak wire rope in turbine oil if soaking is desired.

Lubricant may be applied with a brush, taking care to work it in well. Another method is to pass the wire rope through a box containing the lubricant.

The *Naval Ships' Technical Manual*, chapter 613, calls for lubricating wire rope with a chain lubricant, military specification MIL-G-18458 (ships). This lubricant should be used when possible. When military specification MIL-G-18458 is unavailable, a medium graphite grease or even motor oil may be substituted. Alternative lubricants must come from the PMS list of alternates. Ordinarily lubricants are applied hot so they can penetrate the strands and the core more easily.

WIRE-ROPE FAILURE

The following are some common causes of wire-rope failure:

- Using incorrect size, construction, or grade
- Dragging over obstacles
- Lubricating improperly
- Operating over sheaves and drums of inadequate size
- Overriding or crosswinding on drums
- Operating over misaligned sheaves and drums

- Operating over sheaves and drums with improperly fitted groves or broken flanges
- Jumping off sheaves
- Subjecting to moisture or acid fumes
- Attaching fittings improperly
- Permitting to untwist
- Subjecting to excessive heat
- Promoting internal wear by allowing grit to penetrate between the strands
- Subjecting to severe or continuing overloads
- Kinking

SEIZING WIRE ROPE

Seizing is the process of securing one rope to another, two or more parts of the same rope to itself, or fittings of any kind to a rope by binding with small stuff or with annealed iron wire.

In the manufacture of wire rope, great care is taken to lay each wire in the strand and each strand in the rope under uniform tension. If the ends of the rope are not secured properly, the original balance of tension will be disturbed and maximum service will not be obtained because some strands will carry a greater portion of the load than others. Before cutting steel wire rope, you must apply proper seizing on both sides of the place where the cut is to be made. For preformed wire rope, one seizing on each side is normally enough. For wire ropes that are not preformed, a minimum of two seizings is required, placed six rope diameters apart. Always apply seizing in the opposite direction from the lay of the rope. This prevents loosening when the wire-rope shrinks as a result of loading. Remember that the length of the seizings must never be less than the diameter of the wire rope being seized.

To make a temporary wire-rope seizing, wind on the seizing wire uniformly, using strong tension on the wire. After taking the required number of turns as shown in step 1 in figure 3-31, twist the ends of the wires counterclockwise as shown in step 2. Grasp the ends with end-cutting nippers and twist up slack as shown in step 3. Do not try to tighten the seizing by twisting. Draw up on the seizing as shown in step 4. Twist up slack Repeat steps 4 and 5 if needed. Cut the ends and pound them down on the rope as shown in step 6. If the seizing is to be permanent, or the rope is 1 5/8 inches or more in diameter, use a serving bar or

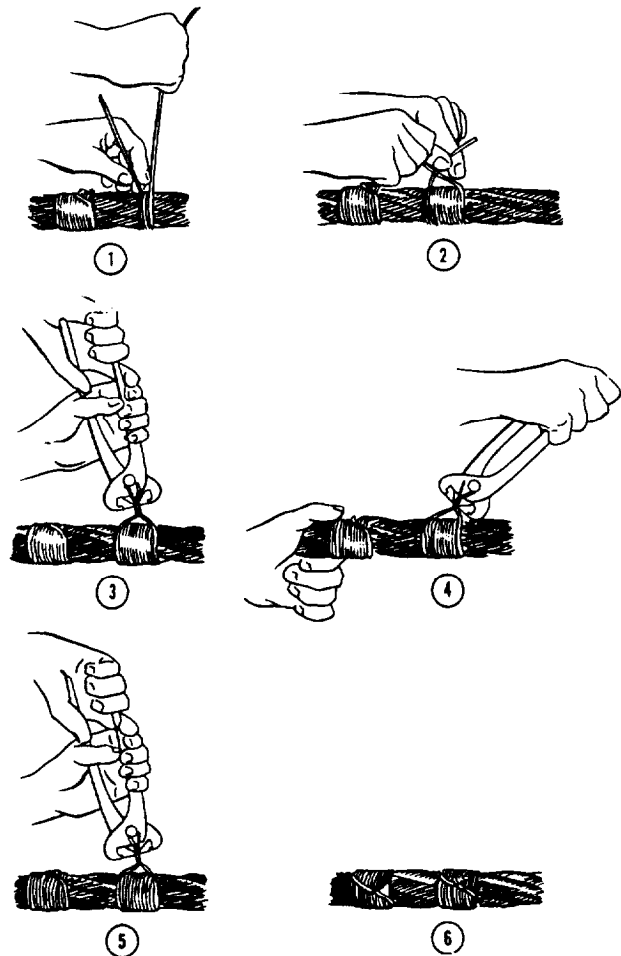

Figure 3-31.—Putting seizing on wire rope.

iron to increase tension on the seizing wire when putting on the turns.

You must use the proper size and grade of wire for seizing. Table 3-3 lists the proper sizes of seizing wire for use with a range of wire-rope diameters.

Table 3-3.—Seizing for Wire Rope

Rope Diameter (inches)	Annealed Iron Seizing Wire Diameter (inches)
1/2 and smaller	0.035
9/16 to 7/8	.063
1 to 1 1/2	0.92
1 5/8 to 2 1/8	.120
2 1/4 and larger	.135

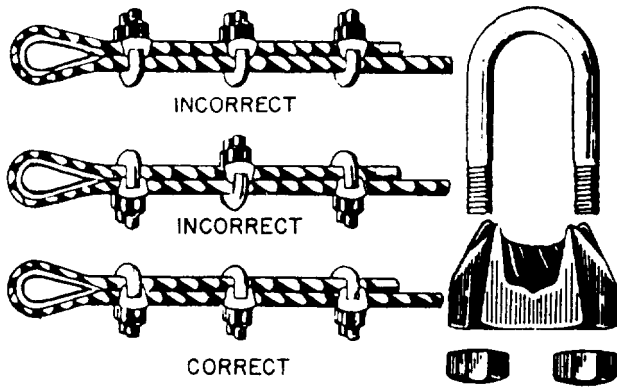

Figure 3-32.—Correct and incorrect use of wire-rope clips.

WIRE-ROPE CLIPS

A temporary eye splice may be put in wire by using wire-rope clips. The correct and incorrect ways of using these clips are shown in figure 3-32. The U-bolt always goes over the bitter end and the roddle goes on the standing part. Space the clips at a distance apart equal to six times the diameter of the wire. After the rope is

under strain, tighten the clips again as a safety measure. The clips must be rechecked periodically thereafter and retightened as needed. Pay particular attention to the wire at the clip farthest from the eye because vibration and whipping are dampened here and fatigue breaks are likely to occur.

To obtain maximum strength in the temporary eye splice, you must use the correct size and number of wire clips. The size is stamped on the roddle between the two holes. The minimum number of clips to use for various sizes of wire rope is shown in table 3-4.

The improved type of wire rope clip is shown in figure 3-33. Both halves are identical and provide a bearing surface for both parts of the rope. Thus, it cannot be put on wrong and it does not distort the wire. It also allows a full swing with a wrench.

Personnel handling wire rope must always wear gloves. Even new wire occasionally has a fishhook that, if allowed to slide through the unprotected hand, can inflict a painful hand injury.

Table 3-4.—Number of Clips Regularly Used as a Minimum

Rope Diameter (inches)	All 6x7 Ropes; All Ropes With Independent Wire Rope Centers	All 6x19 and 6x37 Rope	Proper Torque to be Applied to Nuts of Clips [ft/lb(dry)]
3/8	4	3	45
1/2	4	3	65
5/8	4	3	95
3/4	5	4	130
7/8	5	4	225
1	6	5	225
1 1/8	6	5	225
1 1/4	7	6	360
1 3/8	7	6	360
1 1/2	8	7	360
1 3/4	8	7	590

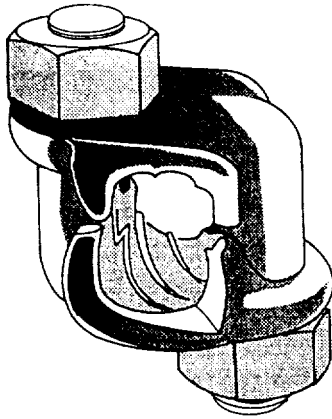

Figure 3-33.—Improved type of wire rope clip.

CANVAS

LEARNING OBJECTIVES: *Define canvas. Identify and explain the use and care of canvas material.*

Though canvas is not as prevalent today in a Seaman's routine as it once was, it is still important.

Canvas, often called duck, is a general name for a class of strong, heavy plain cloth woven of cotton or linen. *Numbered duck* is the canvas encountered most often, but occasionally you see the term *ounce duck* or *army duck*. Numbered duck runs from No. 1, the heaviest, to No. 12, the lightest; however, 7, 9, and 11 are no longer issued.

Each number means a certain weight in ounces per square yard of cloth. For example, No. 1 is 28.71 ounces per square yard, No. 6 is 20.74 ounces per square yard, and No. 12 is 11.16 ounces per square yard. Canvas in weights besides those designated specifically under the numbered system is called ounce duck. Army ducks are ounce ducks similar to numbered duck, but have finer yarns, higher cloth counts, and usually lighter weights.

Canvas usually is made up in bolts and issued by the linear yard in widths from 22 to 72 inches.

Even with the best of care, canvas is relatively short-lived, and for this reason, the Navy is turning to synthetic fabrics. Synthetic fabrics are lighter and easier to stow and resist rot and mildew. They are also more durable and less expensive in the long run.

One type of synthetic fabric used extensively for tarps and awnings and for boat, winch, and reel covers is a nylon cloth with a vinyl film on both sides. (The smooth or face side is the side to expose to the weather.) Two different companies furnish this type of cloth under their own trade names (Herculite #80 and

Hypalon). These white or grey materials weigh approximately 19.6 ounces per square yard and come in 50-inch widths. They are fire, water, weather, and mildew resistant.

Another type of cloth, a black neoprene-coated material, is less suited for topside uses but has many below-deck applications, such as for blackout and welding curtains. This material weighs approximately 2.3 ounces per square yard and comes in a 39-inch width. Generally, the same care given to synthetic lines should be given to the synthetic cloths. When synthetic cloths are dirty, you should wash these fabrics with saddle soap or any other mild soap and water; scrub them with a soft bristle brush, using a circular motion; and rinse them with clear water. In some instances, two cleanings may be necessary.

Much of the canvas issued in the Navy is treated to make it resistant to fire, water, weather, and mildew. Some canvas is waterproof and oil and gasoline resistant. Current specifications for building ships require that all topside canvas be treated according to the intended use. Canvas to be used below decks is usually white and untreated. Preservatives are available for shipboard use on untreated canvas or for re-treating canvas.

New and unused canvas, spare covers, and so forth, should be stowed in a clean, dry storeroom. Never store canvas where acid is (or has been) stowed; acid fumes are detrimental to canvas. Every effort should be made to provide a space free from rats, mice, and insects. Wet, painted, or oil-soaked canvas should not be stowed below decks. Occasionally it is necessary to scrub canvas that has become particularly dirty or stained by grease or oil. Use a mild soap solution, rinse thoroughly, and hang the canvas up to dry.

MEASURING CANVAS

Great care should be taken when measuring and cutting canvas. **MEASURE TWICE AND CUT ONCE.** When measuring canvas for items that will be stretched taut (awnings, for example), **DEDUCT** 1/2 inch for each linear foot in both width and length. If the canvas is to be loose (as for hatch hoods and gun covers), **ADD** 1/2 inch for each linear foot in both width and length. Use the old article for a pattern whenever possible. When it is not available, make a sketch of the item, showing all the necessary dimensions, and work from that.

SEWING CANVAS BY HAND

When you are required to fabricate articles, you will need the appropriate tools. Some of the tools used for fabricating are listed below.

- **Sail needles:** Needles are numbered according to size; the higher the number, the smaller the needle. The heavier the canvas, the larger your needle should be. After use, needles should be dried carefully and oiled or stowed in a container of powdered chalk to prevent them from rusting.

- **Palms:** Two types of palms are issued in the Navy: the sailmaker's palm and the roping palm. At first glance you probably see no difference, but if you check the metal slug you can see that the roping palm is designed for larger size needles. This is the palm to use when jobs require the largest needles—sewing on bolt ropes, for example.

- **Sailmaker's or bench hook:** This hook has a swivel eye. It is used to hold the ends of two pieces of canvas being sewn together, as shown in figure 3-34.

- **Beeswax:** This substance can hardly be called a tool, but it is a necessary item. It reduces the wear on the sail twine while sewing and retards deterioration.

- **Sail twine:** Many different types of twine are used for sewing, mostly cotton; but lacing twine (already waxed) is best for sewing by hand.

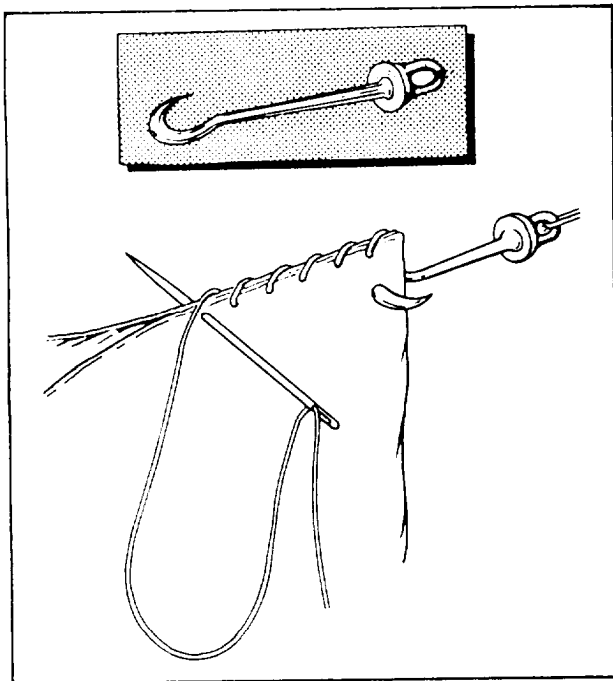

Figure 3-34.—Round stitching canvas held by a bench hook.

Stitches and Their Uses

Here are some of the common stitches that you will find useful in your work.

- **Round stitch:** The round stitch is the one used most commonly for joining two pieces of canvas. Turn back the edges, hold the pieces together, and send the needle through both pieces at right angles at the seam, as shown in figure 3-34.

- **Flat stitch:** A flat stitch is used when a strong seam is required, as on a paulin or a sail. Pencil a guideline 1 1/2 or 2 inches from the edge of each strip of canvas, depending on how wide you want the seam. Crease each piece on a line slightly less than halfway to the guideline. Make the folds away from the guidelines and interlock the folds away from the guidelines and interlock the folds (fig. 3-35). Interlocking the edges forms a watertight seam and keeps a ragged edge from showing. Insert the needle at the guideline, and stitch diagonally so that stitches appear at right angles to the seam on top but run at an angle on the reverse side. After completing one edge, turn the canvas over and sew the other edge of the seam. Flat stitching also is used for patching.

- **Baseball stitch:** The baseball stitch is used to mend tears in light and medium canvas. Figure 3-36 shows how it is done.

- **Herringbone stitch:** The herringbone stitch is used to mend tears in heavy or painted canvas. Figure 3-37 shows the steps in making this stitch.

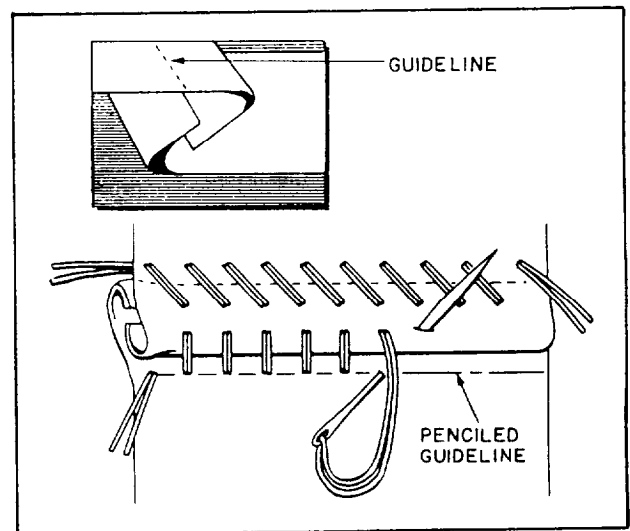

Figure 3-35.—Flat stitch.

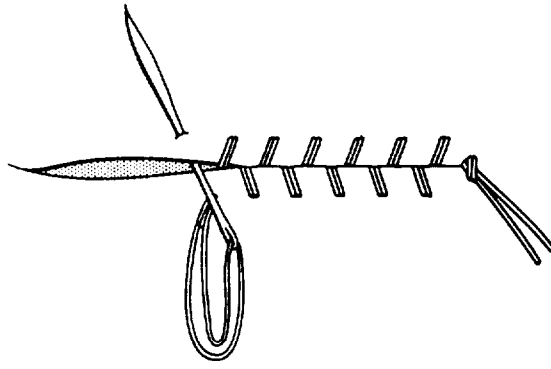

Figure 3-36—Baseball stitch.

Sewing Bolt Ropes to Canvas by Hand

Bolt ropes are the ropes around the edges of awnings and sails. Their purpose is to take the strain of the stops, clews, reef points, and the like. To sew on a bolt rope, hem the canvas and lay the rope along the edge. Use a round stitch, the size of which is determined by the size of the rope. Sew the rope strand by strand to

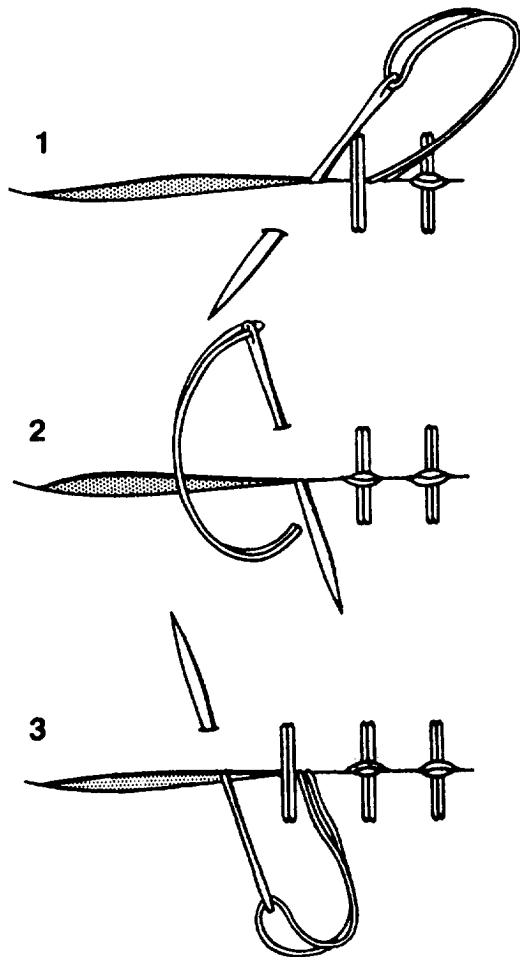

Figure 3-37.—Herringbone stitch.

the canvas as shown in figure 3-38. Carefully observe these points when sewing on bolt ropes.

1. Keep the rope taut and the canvas slack.
2. Do not bunch the canvas, but hold your needle at such an angle that it goes through the canvas a fraction of an inch ahead of where it comes out from under the strand.
3. Sew each strand to the canvas, making sure the needle goes under, not through, the strands.
4. Do not let your stitches start to creep up around the rope, but keep them coming out of the rope in a straight line along the underside. If you let them creep, the canvas begins to curl around the rope.
5. **SEW THE BOLT ROPE TIGHT.**

AWNINGS

Awnings are canvas or synthetic coverings spread over the decks of a vessel to protect the crew from sun and weather. The center of an awning is held up by a strong fore-and-aft wire rope jackstay supported by intermediate stanchions. There may be a wooden strongback in place of the jackstay and others leading from it to the rail. The edges of the awning are hauled out and secured to ridge ropes along the rail. The ridge ropes in turn are supported by specially braced stanchions that usually can be taken down when the awnings are not in use. Edges of some awnings are secured to the ridge rope by lacings reeved around the ridge rope and through grommets in the awning or through awning hooks sewn to the bolt ropes. Other awnings are equipped with stops and earrings (short lengths of line) spliced into the grommets. Earrings are larger and longer lines than the stops. They are spliced to the corner grommets and to the grommets that line up with the ridge-rope stanchions.

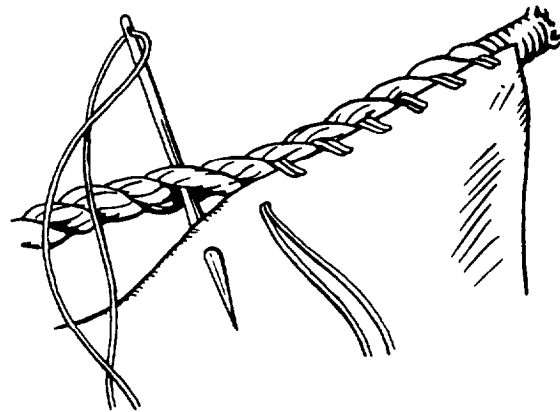

Figure 3-38.—Sewing a bolt rope to canvas.

When you are spreading an awning, haul it over the jackstay and spread it out fore and aft. If the awning is large and heavy, it may be necessary to rig a block and tackle to haul it taut. Next, man and reeve the earrings around the ridge rope. Pull them taut and secure them temporarily to the ridge ropes. Reeve, set taut, and secure the stops temporarily to the ridge ropes. It will be necessary to go back and tighten all stops and earrings to take the sag from the awning. Earrings and stops are secured by wrapping their bitter ends around the parts reeved through the grommets and around the ridge rope, tucking the ends between the parts.

During rains, awnings must be housed to allow them to shed water better. This is done by casting off two or more stops between earrings and securing them lower down to the lifeline. When awnings are secured by long lacings reeved through a number of grommets, it is almost impossible to house them. It may be to your advantage to replace the lacings with earrings and stops.

In particularly windy weather, awnings sometimes are furled. To furl an awning, you cast off the stops and earrings and haul one edge across the jackstay to the other side. Then roll the awning up and secure it to the jackstay with marline hitches.

GROMMETS

Many repair facilities today such as shore intermediate maintenance activities (SIMAs) routinely manufacture canvas items such as awnings and gun covers. However, you may still have to insert grommets. For this reason you should have a basic knowledge of grommets.

Handsewing Grommets

Metal grommets have almost replaced the handsewn type, but if you should ever be caught without the proper size of metal grommets, you should know how to make them by hand. Handsewn grommets are almost as strong as the metal type when they are properly made and sewn to the canvas.

The first step is to fashion a two- or three-strand grommet of marline. Stretch this over a fid to make it round and firm. Double your sail twine, twist the two parts together, and wax it adequately. Then punch a hole slightly smaller than the grommet in the canvas. Sew the grommet into the hole using a round stitch. Pass the needle through the canvas, well back from the edge. After completing the stitches, shape the grommet again with a fid.

Using Metal Grommets

Several different types of metal grommets are in use, but the two that are most familiar are pictured in figure 3-39. The one in view A is called the eyelet-and-ring type; it comes in sizes 6 to 15, inclusive, with inner diameters from 3/4 inch to 2 inches. View B shows the spur type. It is in sizes 0 to 6, inclusive, with inner diameters from 1/4 to 3/4 inch.

The cutting punches shown range in diameter from 1 inch down to 7/16 inch in the double bow type (view C), and from 3/8 to 1/8 inch in the single bow type (view D). When you are using these to punch holes in canvas, lay the canvas on a piece of heavy sheet lead, and they will cut a neat, clean hole.

The grommet-inserting punches and dies are available in sets in the same sizes as the grommets; that is, from 0 to 15. Use the same size set as the size of grommet. In figure 3-39, view E shows the punch and view F shows the die.

The proper way to insert the spur type of grommet is to push the eyelet part of the grommet through the hole in the canvas. Place the eyelet on the die and the spur over the eyelet. The punch fits inside the eyelet and, when struck with a hammer, curls the edge of the

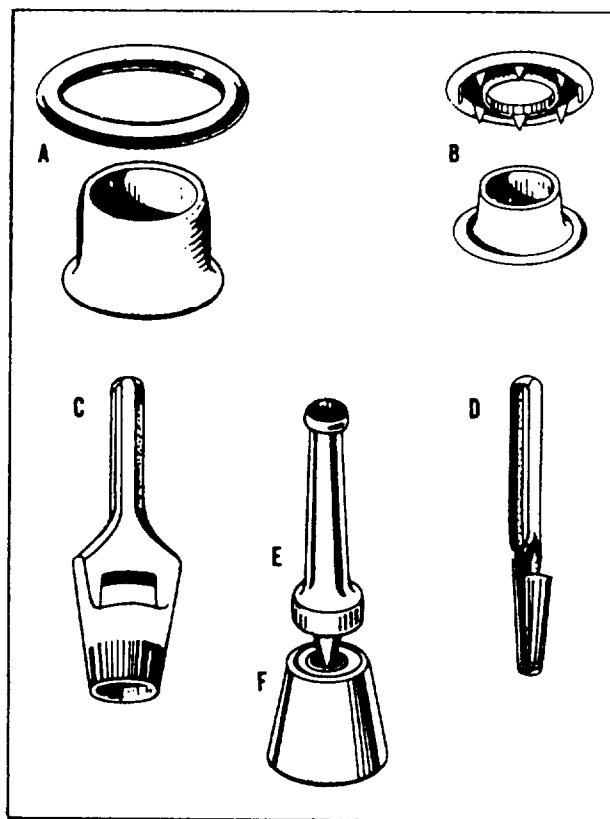

Figure 3-39.—Grommets, cutting punches, and inserting punch die.

eyelet down over the spur. Do not pound too hard on the punch because that causes the grommet to cut through the canvas and later it may pull out.

The eyelet and ring type of grommet is especially for awnings and sails. Properly used, this is the best of all types. The ring part is sewn to the canvas the same as the handmade grommet. Then the eyelet is placed in the ring and set with the punch and die.

LEATHER

*LEARNING OBJECTIVES: Define leather:
Explain the use and care of leather.*

Hides and skins, being of animal origin, vary in area, thickness, and weight. Subsequent tanning and finishing processes further alter these features. The following information concerning the areas, thickness, and weights is, therefore, only approximate.

The types of leather include rigging, harness, shoe, chamois, kid, lacing, belting, and various artificial leathers. Of these, the three you are most likely to need are rigging, belting, and artificial leathers.

Rigging leather is designated by weight as light, medium, or heavy, ranging from 6 ounces per square foot to 10 ounces per square foot. It is issued by the pound.

Belting is either round or flat and is issued in any desired length by the linear foot. Round belting comes in two widths, 1/4 inch and 3/8 inch. Width is used instead of diameter because, despite the name, it is oval rather than round. Flat belting may be either single- or double-ply. Single-ply belting is in 1- to 6-inch widths; double-ply, 2- to 12-inch widths.

The most common types of artificial leathers are used for upholstery and are issued by the square foot.

CARE OF LEATHER

Leather exposed to the elements should be kept well oiled or waxed. Any oil that does not contain harsh chemicals is suitable, but the best is neat's-foot oil. Leather in such places as on lifelines may be kept well-preserved by the application of paste wax. Saddle soap, an excellent preservative and cleaner, can be used on holsters, and on shoes, jackets, and other leather wearing apparel. If leather becomes badly soiled and stained, wash it with a mild soap and water solution, rinse well, and dry in a spot away from intense heat.

After it is dry, apply saddle soap or neat's-foot oil to replace the natural oils of the leather.

Leather is especially subject to mildew and rotting. It is also highly susceptible to accidental cutting, gouging, and abrading. Excessive heat causes it to shrink considerably, with consequent rending and cracking. Acids, corrosives, or their fumes have a disastrous effect upon leather.

The foregoing conditions should be borne in mind when stowing leather. Rolls must have top stowage to prevent crushing. Stowage must be well clear of any liquids or greases that might stain. To prevent sticking, paper should be placed between hides stowed one on top of the other. Original moistureproof wrappers should be left on as long as possible to prevent mildew. Stowage should always be in a dry, well-ventilated compartment.

SEWING LEATHER

On leather, the line along which the stitches are to run on each edge should be grooved so as to countersink the stitches below the surface. When joining two pieces of leather by sewing by hand, first draw a line parallel and close to the edge first, then make your groove with a grooving tool (a dull knife will do). Use a block of wood for a straightedge. Next, punch holes along the grooves for the stitches.

The shoemaker's or cobbler's stitch is shown in figure 3-40. A variation of this stitch is to cut the leather carefully so that the edges abut. Angle the grooves toward the edges of the leather and sew through the

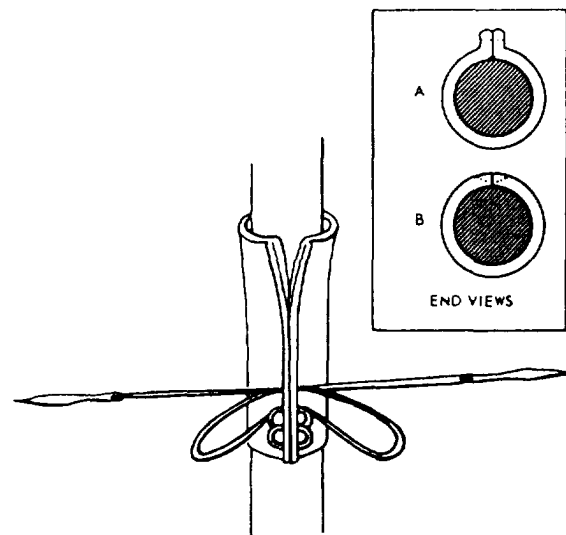

Figure 3-40.—Shoemaker's stitch.

edges. Inset A of figure 3-40 shows the end view of the regular shoemaker's stitch. Inset B shows the variation.

Leather, of course, handles and sews much easier if it is soaked in water for a few minutes.

SUMMARY

In this chapter, we discussed the purpose and use of various knots, bends, and hitches, and the correct method of applying seizing to wire rope and whipping

on a line. We also discussed the uses of the eye and short splices.

During your naval career, you will be called upon to act quickly in an emergency or during routine duties to have proficiency in the act of tying knots, bends, and hitches.

Your ship's leading Boatswain's Mate, who is well qualified from years of experience, will help you in mastering any of these procedures. Do not hesitate to seek assistance if you need it.

CHAPTER 4

DECK SEAMANSHIP

In general, rigging is a large part of deck seamanship. The ship's standing rigging consists of lines, wires, turnbuckles, and other gear supporting and attached to the stacks, the masts, and the topside structure. Running rigging includes the rigging used in hoisting and lowering heavy weights or in positioning and operating movable deck gear.

GROUND TACKLE

LEARNING OBJECTIVES: Define ground tackle. Identify and describe equipment associated with ground tackle.

Ground tackle is all equipment used in anchoring and mooring with anchors and buoy mooring with chain and appendages. The following are defined as ground tackle:

- Anchors
- Anchor chain, wire rope, synthetic line, or combinations of these materials, when used with anchors
- Appendages consisting of connecting shackles or links, detachable links, pear-shaped links, end links, bending shackles, mooring shackles, mooring swivels, detachable-link tool sets, clear hawse pendants, dip ropes, chain stoppers, wrenches for chain stoppers, outboard swivel shots, chain cable jacks, mooring hooks, chain hooks, anchor bars, and anchor buoys

Ground tackle is one of the most vital parts of a ship's equipment. The vessel's safety frequently depends upon the proper use of this gear; suitable ground tackle has saved many ships and lives.

The anchor windlass, equipped with capstan head or gypsy heads, is a vital part of the ship's ability to handle its ground tackle and use the capstan or gypsy heads in mooring and warping operations.

SHIPS' ANCHORS

All anchors are designed to take hold as quickly as possible after they hit bottom. They take hold in one of

two ways: either by hooking into the ground with one or both of their sharp flukes or by burying themselves completely. When an anchor is let go in fairly deep water, it strikes the bottom *crown first*. From this position, any drag on the chain causes the flukes, if properly set, to dig into the bottom. As the drag continues, the fluke is forced further into the bottom. If the proper scope of chain is used, the heavier the drag, the deeper the fluke will dig in, developing the full holding power of the anchor.

CHAIN AND WIRE ROPE CABLES

Chain, wire rope cables, or cable composed of both chain and wire rope for use with ships' anchors is a part of the ship's ground tackle. *Ground tackle* is the collective term applied to all equipment used in anchoring. It includes the anchors, their chain or cables, connecting fittings, and all associated equipment used in anchoring, mooring with anchors, buoy mooring, being towed, or securing or letting go anchors in or from their hawsepipes.

ANCHORS

LEARNING OBJECTIVE: Identify and describe the anchoring equipment used aboard ships.

Anchors used in the Navy today are grouped according to type. The most common types used are stockless anchors, lightweight (LWT) or stock-in-crown anchors, and two-fluke balanced-fluke anchors. Stock anchors (old-fashioned) and mushroom anchors are no longer specified as a part of Navy ship ground tackle.

STOCKLESS ANCHORS

Though there are a number of different designs of modern stockless anchors, all share the same distinguishing feature—they are stockless.

Three designs of stockless anchors are in use on naval ships: commercial, standard Navy, and the Mark 2 (Mk 2). These are shown in views A, B, and C of

figure 4-1. Of the three, the Mk 2, with its long flukes, has the greatest holding power. It is made only in the 60,000-pound size for use aboard aircraft carriers. The short, commercial-type flukes have the least holding power.

The stockless feature of these anchors provides many advantages, not only in easing handling and stowing, but also in allowing the anchor to be hoisted directly into the hawsepipe and secured, ready for letting go.

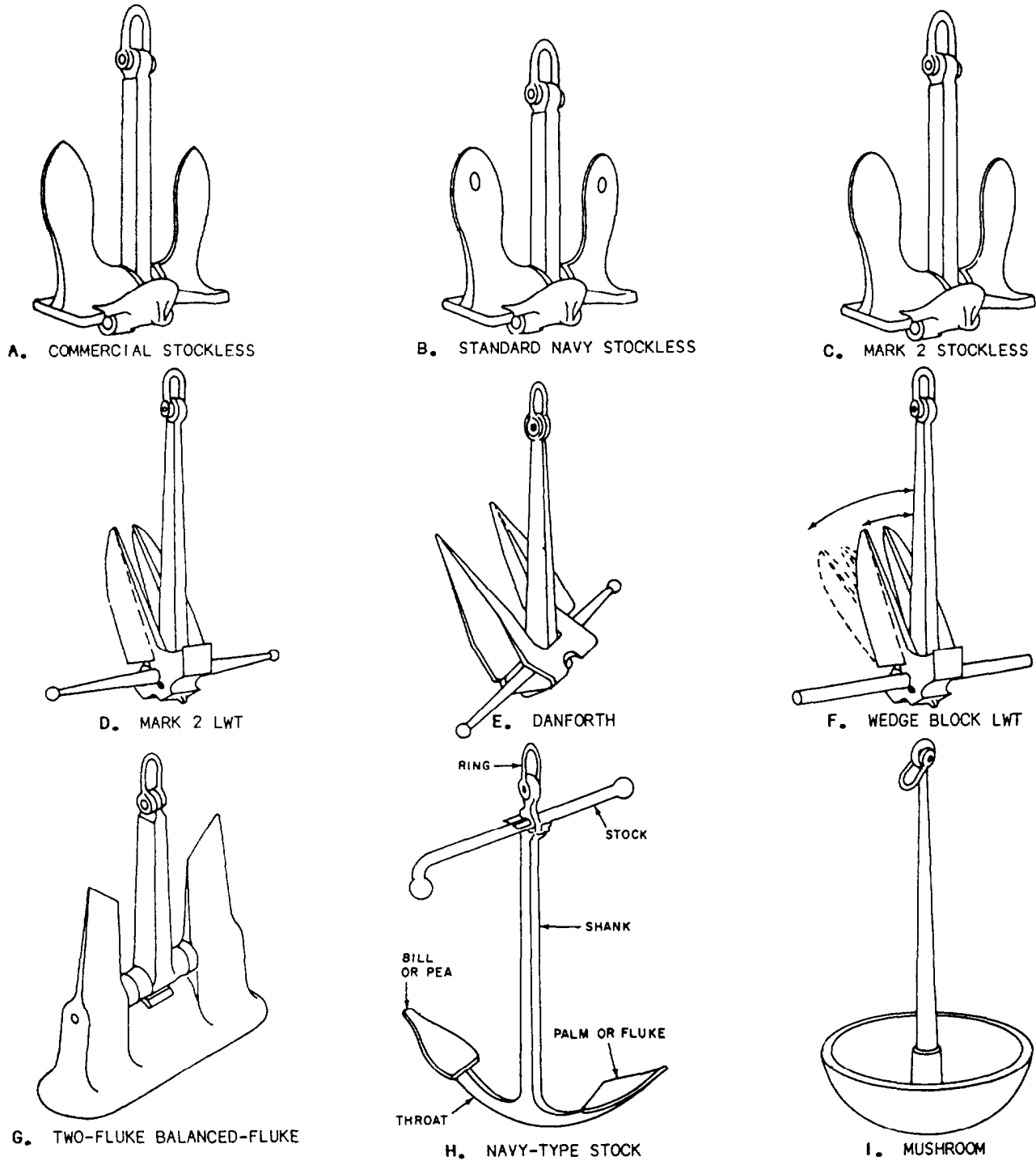

Figure 4-1.—Types of anchors.

The stockless anchor consists of a heavy head in which the crown, tripping palms, and flukes are forged in one piece. This unit is pivoted on the shank so that it can swing from 45° to either side of the shank. The flukes are large and long, and projecting shoulders or tripping palms are cast at the base of the flukes to make them bite. As the force of the drag exerts itself, the shoulders catch on the bottom and force the anchor to take hold by pushing the flukes downward into the bottom. Because an upward pull on the shank of a stockless anchor has a tendency to break out the flukes, a long scope of chain must be used to make sure the shank remains on the bottom when the anchor is set. With too short a scope, or even under a steady pull with a long scope, a stockless anchor may still disengage its flukes as a result of gradually turning over and rolling out. Under this condition, the anchor can offer no resistance to dragging except by its weight.

LIGHTWEIGHT ANCHORS

Two types of lightweight anchors are used on Navy ships: the Mk 2 LWT and the wedge block LWT anchor. These are shown in views D and F of figure 4-1.

Lightweight anchors are constructed of comparatively light metal, but are very strong in tension. They gain their holding power by digging deep into the bottom rather than lying as a deadweight.

Both the Mk 2 LWT anchor and the wedge block LWT anchor have high holding power for their weights. The 30° fluke angle on the wedge block LWT anchor is most effective in sand bottoms; and the 50° fluke angle, in mud bottoms. For example, both 10,000-pound LWT anchors are designed to have a holding power in a sand bottom slightly higher than the 22,500-pound standard Navy stockless anchor. They are used as bower and stern anchors and may also be used as stream or kedge anchors. Anchors less than 150 pounds are normally used as small boat anchors.

The main characteristic of the LWT anchor is the placement of large flukes at such an angle that they drive deep into the bottom to ensure good holding power. The crown is designed to lift the rear of the flukes and force their points downward into the bottom. Good stability is also obtained by placing the flukes close to the shank.

These anchors are extremely useful in any situation where *lightweight but good holding power* is essential. They have even been cast up to 3,000 pounds for use as stern anchors on LSTs. For Navy use, LWT anchors are made in approximate weights from 8 pounds to 13,000

pounds, for the Mk 2 LWT 6,000 pounds and 30,000 pounds for the wedge block LWT. The commercial Danforth anchor, shown in view E of figure 4-1, is used on some Navy craft and small boats.

TWO-FLUKE BALANCED-FLUKE ANCHORS

The two-fluke balanced-fluke anchor (view G of figure 4-1) is used for anchoring some surface ships and the newer submarines and is normally housed in the bottom of the ship. This anchor is used on certain combatant-type surface ships in place of a bower anchor, which could interfere with the ship's sonar dome.

STOCK ANCHORS

Old-fashioned, or stock, anchors (view H of figure 4-1) have been abandoned by large merchant and Navy ships because they are extremely cumbersome and difficult to stow. Because of their superior holding power, stock anchors are still used on some boats, and yachtsmen use them for small craft.

MUSHROOM ANCHORS

Mushroom anchors are shaped like a mushroom with a long narrow stem serving as the shank. Because of their excellent holding ability, they are used for permanent moorings and as anchors for channel buoys and other navigational aids. The mushroom anchor (view I of figure 4-1) is used to anchor buoys and torpedo testing barges. The rounded part, or crown, strikes the bottom first, and the upper surface of the mushroom is cupped to provide a biting surface. As the anchor shifts back and forth under strain, it digs itself deeper into the bottom, thereby increasing its holding power. Consequently, it takes a firm hold and remains fixed under the most adverse conditions. Because the mushroom anchor has no projecting stock or flukes to foul, the moored object can swing freely around a mushroom anchor. However, since a mushroom anchor will break out if the direction of pull is reversed, it is normally used only in groups of three or more, surrounding the central mooring point. Certain older class submarines use this type of anchor.

CHAIN AND APPENDAGES

Present day Navy anchor chain of the flash butt welded type is the Navy standard for new ship constructions and replaces die-lock chain as required

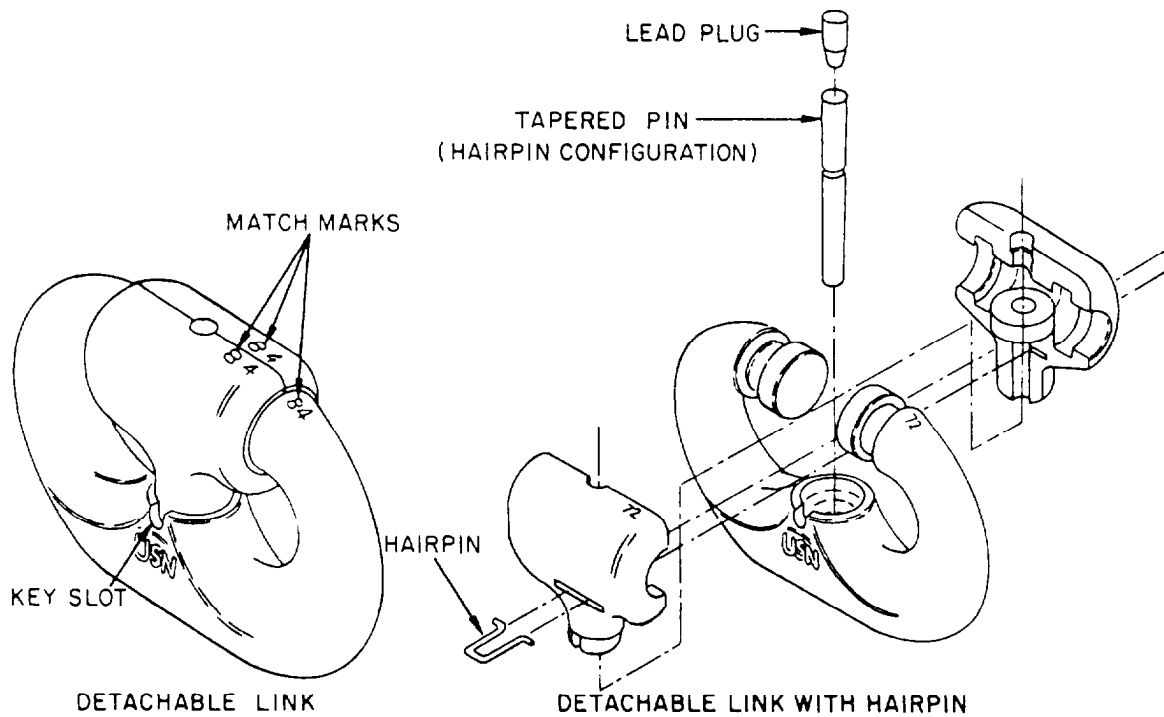

Figure 4-2.—Detachable link.

for back fit. All links are studded; that is, a piece of steel is placed in the center of the links. Studs prevent the chain from kinking and the links from pounding on adjacent links. The *Naval Ships' Technical Manual* lists standard sizes from 3/4 inch to 4 3/4 inches, and details the method of fabrication. The size of the link is designated by its nominal diameter, which is called wire diameter. Wire diameter is measured at the end of the link a little above the center line. The length of a standard link is 6 times its wire diameter, and its width is 3.6 times its wire diameter.

An anchor chain is made up of many parts besides common links and requires a variety of equipment and fittings to use and maintain the chain. The following descriptions will acquaint you with the details of anchor chain and some of the equipment associated with using and maintaining the chain.

Standard Shot

The lengths of chain that are connected to make up the ship's anchor chain are called shots and are made up with an odd number of links. A standard shot is 15 fathoms (90 feet) long. At the time of its manufacture, each shot of the chain usually bears a serial number stamped, cut, or cast on the inner side of the end links of each shot. If an end link is lost or removed from a shot, this identification should be cut or stamped on the

inside of the new end link of the altered shot. Chapter 581, *Naval Ships' Technical Manual*, defines in considerable detail chain make-up, fittings, replacement, maintenance and rejection criteria.

Detachable Links

Shots of anchor chain are joined by a detachable link, shown in figure 4-2. The Navy-type detachable link consists of a C-shaped link with two coupling plates that form one side and stud of the link. A taper pin holds the parts together and is locked in place at the large end by a lead plug. Detachable link parts are not interchangeable, so matching numbers are stamped on the C-link and on each coupling plate to ensure its identification and proper assembly. You will save time and trouble trying to match these parts if you disassemble only one link at a time and clean, slush, and reassemble it before disassembling another. The present day slush, a preservative and lubricant, is a mixture of 40 percent white lead and 60 percent tallow by volume. Other slush mixtures are being investigated to replace the white lead. When you re-assemble a detachable link, make sure the taper pin is seated securely. This is done by driving it in with a punch and a hammer before inserting the lead plug over the large end of the pin. Detachable link toolbox sets contain tools, including spare taper pins and lead plugs, for assembling and disassembling links and detachable end links.

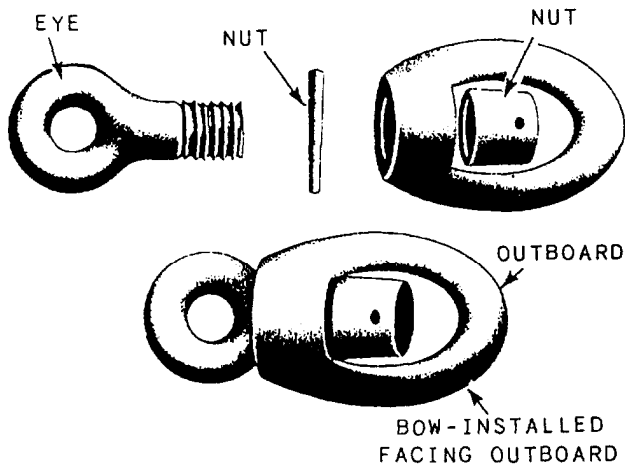

Figure 4-3.—Chain swivel.

Chain Swivels

Chain swivels (fig. 4-3) are furnished as part of the outboard swivel shot. They reduce kinking or twisting of the anchor chain.

Bending Shackles

Bending shackles (fig. 4-4) are used to attach the anchor to the chain.

Outboard Swivel Shots

Standard and alternate outboard swivel shots also called “bending shots,” consist of common links and fittings as shown in figure 5-4. They are fitted to attach the 15 fathom shots of anchor chain to the anchor. They also make it possible to stop off the anchor outboard of the swivel and break the chain at the detachable link inboard of the swivel. This allows the anchor chain to be used as part of the towing gear. Outboard swivel shots vary in length, but they usually do not exceed 5 fathoms. The taper pins in the detachable links in the outboard swivel shot are additionally secured with a U-shaped, stainless steel wire-locking clip (sometimes called a hairpin). This hairpin, inserted in holes drilled through the coupling plates, engages a keyway or groove on the taper pin and is mandatory. (See figures 4-2 and 4-4.)

Riding, Housing, and Towing Chain Stoppers

Riding and housing chain stoppers consist of a turnbuckle inserted in a couple of links of chain. A pelican hook is attached to one end of the chain; a shackle is attached at the other end. The housing stopper is nearest the hawsepipe and must be installed outboard of the swivel; the riding stopper is farther inboard. These stoppers are secured by the shackles to permanent pad eyes on the ship's deck. Chain stoppers

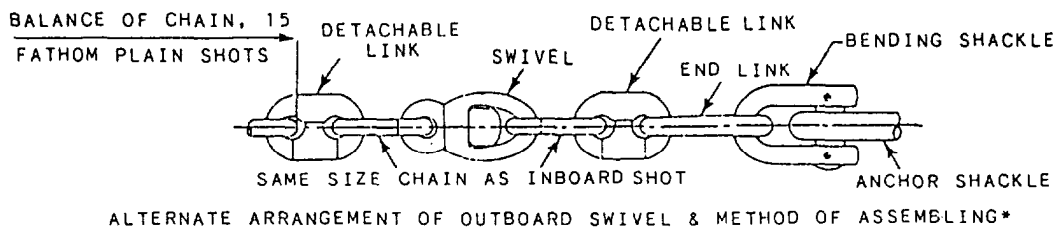
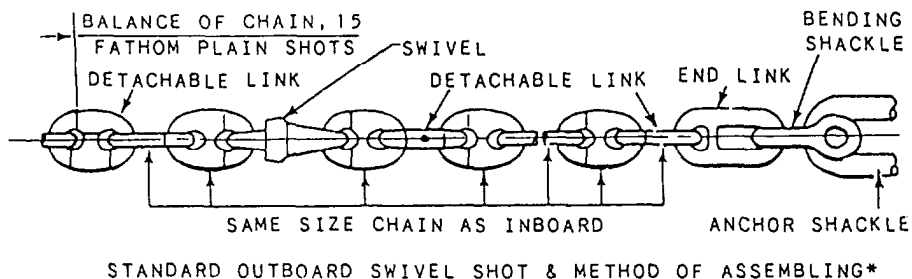

*** NOTE**

STANDARD AND ALTERNATE OUTBOARD SWIVEL SHOTS SHOWN REFLECT LATEST DESIGN ON LATER SHIP CLASSES USING FLASH BUTT WELDED CHAIN. VARIOUS ARRANGEMENTS WILL EXIST ON OTHER SHIPS USING DIE-LOCK CHAIN WITH COMMON LINES ON EACH SIDE OF THE SWIVEL.

Figure 4-4.—Outboard swivel shot arrangement.

are used to hold the anchor taut in the hawsepipes, to ride to an anchor, or to hold the anchor when the anchor chain is disconnected for any reason.

When in use, a stopper is attached to the anchor chain by passing the tongue over a link of the chain and securing it by engaging the bail of the Pelican hook and passing a toggle pin. When riding to anchor with more than one stopper on the chain, the strain must be equalized in the stoppers by adjusting the settings of the turnbuckles. Large chain stopper wrenches are used for this purpose. Special housing chain stoppers, such as devil's claw or pawl-type stoppers, normally are used with horizontal windlasses and where space limitations do not permit use of Navy standard stoppers. Although stoppers alone are more than adequate for holding the anchor, they should be backed up with the wildcat brake. Upon anchoring, first the wildcat brake band should be set up tight, then the stoppers should be passed. The wildcat should be left disconnected from the windlass. A Navy standard chain stopper is shown in figure 4-5.

Towing chain stoppers are similar to riding chain stoppers and housing chain stoppers except towing chain stoppers have locking plates added. These locking plates prevent the towing chain stoppers from unscrewing when they are subjected to the shock and vibration loading of the towing hawser. Chapter 581 of the *Naval Ships' Technical Manual* has detailed information on towing chain stoppers.

Mooring Shackles

Forged steel mooring shackles (fig. 4-6) are used to attach the anchor chain to mooring buoys. All mooring shackles, regardless of size, have a standard opening of 7 inches. Mooring shackles are not to be used for any other purpose.

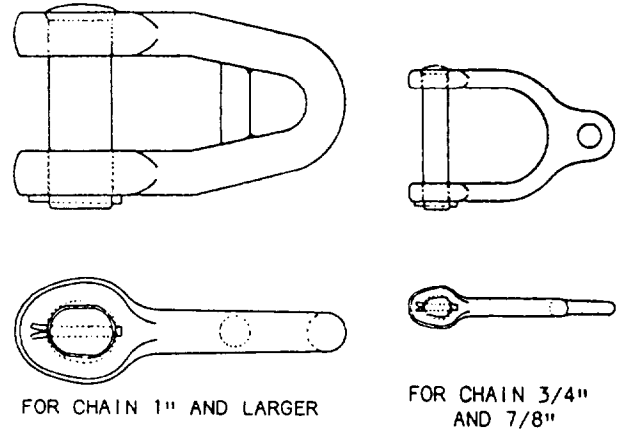

Figure 4-6.—Mooring shackles.

Mooring Swivels

Forged steel swivels, with two links attached at each end, are used to moor with anchors. They are inserted in the chain outboard of the hawse and serve to keep the chain from twisting as the ship swings. Mooring swivels are attached in the chain with the eye end outboard, or down, to prevent them from hooking on the outer lip of the hawse when they are heaved back aboard. However, ships today have large rounded lips on the hawsepipes, making it unlikely that a reversed swivel will catch. A mooring swivel is shown in figure 4-7.

Chain Cable Jacks

A cable jack (fig. 4-8), consisting of a lever mounted on an axle and two wheels, is used to handle anchor chain of 2 3/4 inches, or larger, in size. It is used to pick the chain up to pass a chain stopper. A pinch-point crowbar type of anchor bar is issued for smaller sizes of chain.

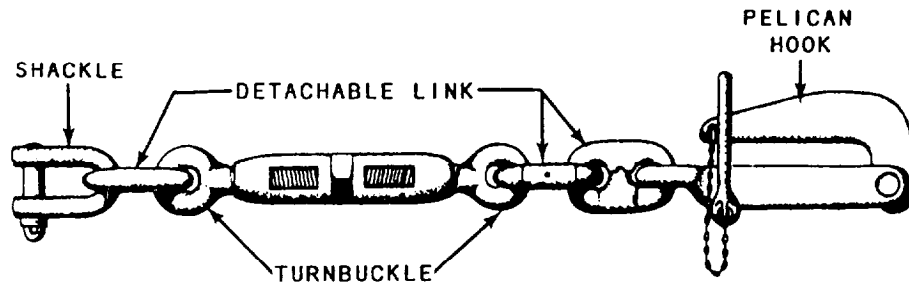

Figure 4-5.—Navy standard chain stopper.

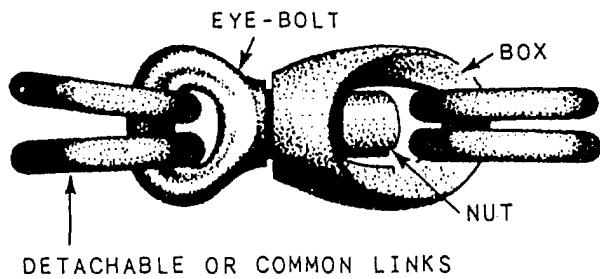

Figure 4-7.—Mooring swivel.

Clear Hawse Pendants

A clear hawse pendant is a wire rope pendant, 5 to 15 fathoms long, with a thimble at one end and a pelican hook attached to a length of open-link chain fitted in a thimble at the other end. This pendant is used to clear a hawse fouled by the anchor chain. See figure 4-9.

Dip Ropes

A dip rope is a fiber or synthetic rope pendant, 14 to 36 fathoms long, fitted at one end with a thimble and a dip shackle large enough to engage a link of the anchor

chain. A dip rope is used when mooring or clearing a hawse.

Chafing Chain or Pendant

A short length of chain and/or a wire rope pendant is inserted between the anchor and the anchor buoy line. This prevents the anchor buoy line from chafing on the anchor and parting.

Anchor Chain Markings

The detachable links of anchor chains are painted red, white, or blue as follows: red for 15 fathoms, white for 30 fathoms, blue for 45 fathoms, red for 60 fathoms, white for 75 fathoms, and so on.

At the 15-fathom mark, one link on each side of the detachable link is painted white, and one turn of wire is wrapped securely around each stud. At the 30-fathom mark, two links on each side of the detachable link are painted white, and two turns of wire are wrapped around each of the last white studs. At 45 fathoms, three links on each side of the detachable link are painted white, and three turns of wire are wrapped around each

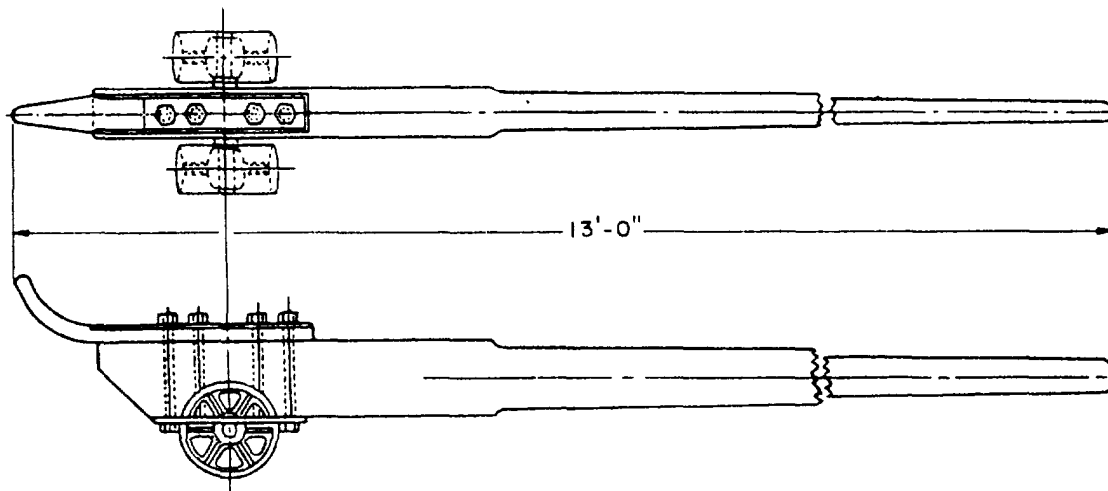

Figure 4-8.—Cable jack.

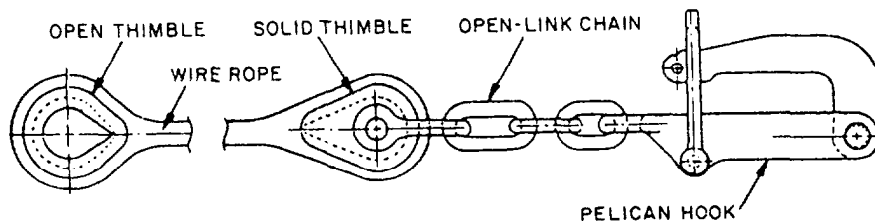

Figure 4-9.—Clear hawse pendant.

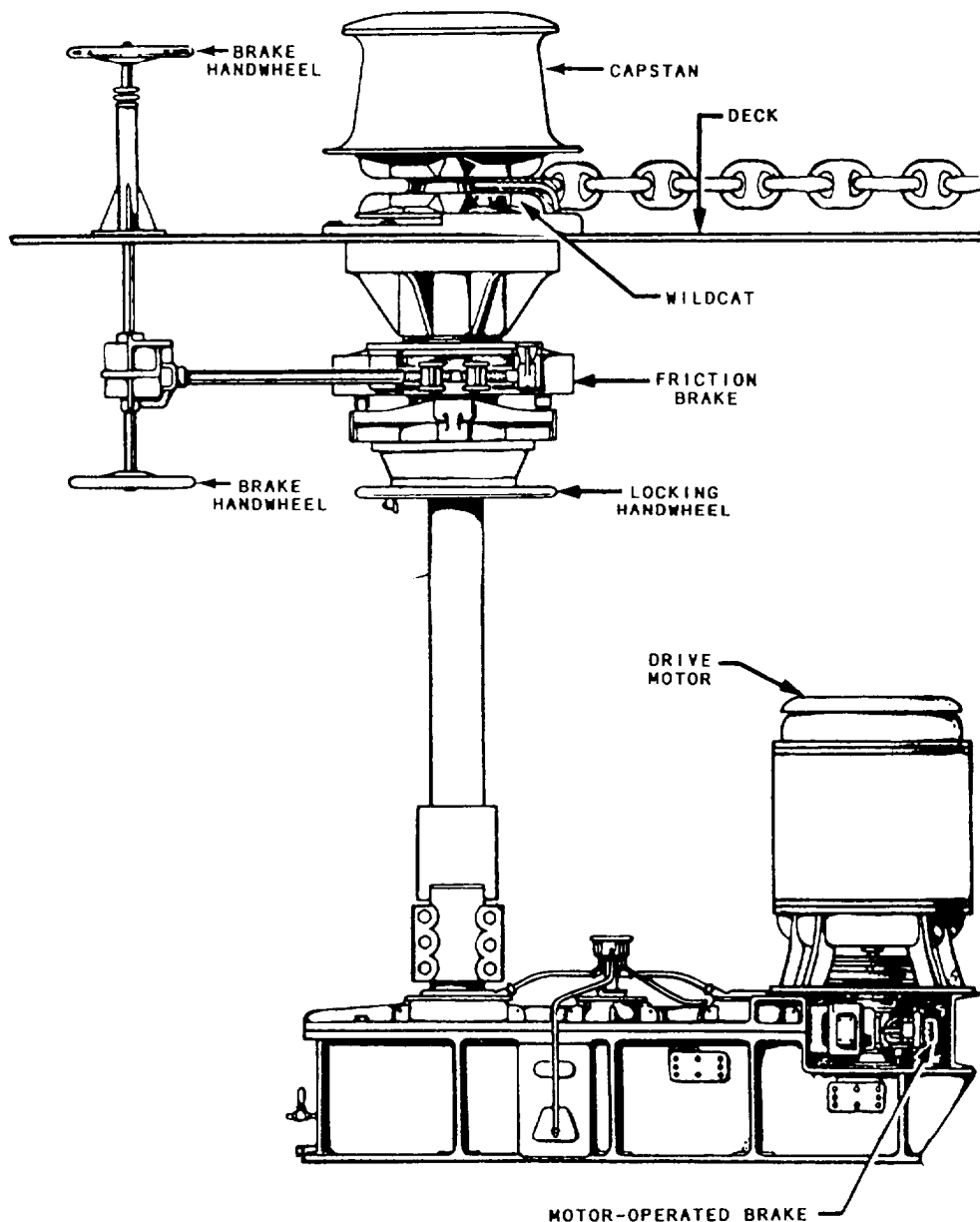

Figure 4-10.—Vertical shaft anchor windlass.

of the last white studs. At 60 fathoms, four links on each side of the detachable link are painted white, and four turns of wire are wrapped around each of the last white studs; and so on for each shot.

Each link of the entire next-to-last shot is painted yellow. The last shot is entirely red. These last two shots give warning and danger signals of the approach of the bitter end of the anchor chain.

CARE OF GROUND TACKLE

Anchors, chains, and appendages must be kept in good condition by the ship's force. The chain is

overhauled by the ship's force whenever necessary, and precautions are taken to see that the various shots are properly marked and in good order. Two competent petty officers are detailed to examine the chain as the chain comes in, when getting underway, from an anchorage. Each link is examined for cracks and other defects.

Once each quarter, and more often if subjected to normal use, all anchor chains in sizes up to and including 1 1/2 inches are laid on deck and their entire lengths examined. The deck pad eyes and chain stoppers are inspected for cracks, deformation, and

excessive wear at this time. If necessary, they are scaled and cleaned of rust and other foreign matters, checked for excessive wear or corrosion and, where conditions warrant, replaced with new ones.

Disassembly of detachable links in the outboard swivel shot with hairpins requires removal, and probable destruction, of the lockwire. The availability of replacement wire of the same type should be established before removal for inspection of the detachable link. Replacement hairpins can be fabricated on board ship from corrosion-resistant steel.

Anchor chain and appendages are carefully examined for cracks, excessive wear, distortion, or other defects. Parts that require coating are painted with anchor chain gloss black paint. Shackles, bolts, locking pins, and swivels are examined carefully and put in order. The turnbuckles in chain stoppers require frequent attention to keep them clean, free from rust, and well lubricated with a graphite grease.

Chain of sizes by more than 1 1/2-inch wire diameter is overhauled, wire brushed, and placed in a good state of preservation as often as required. At least once every 18 months all anchor chain, regardless of size, (including all fittings) is examined, overhauled, and placed in a good state of preservation (5 years for carriers). To distribute the wear uniformly throughout the length of the chain, the shots are shifted to a new position as necessary during this inspection. If, during overhaul of the chain, significant defects are discovered, they are brought to the attention of the Naval Sea Systems Command. If it is not practical to make immediate replacement, the defective shots are shifted to the bitter end of the chain. Chapter C6, Volume 2 of OPNAVINST 5100.19 (series) (*NAVOSH Program Manual for Forces Afloat*) contains safety precautions on ground tackle.

ANCHOR WINDLASS

Windlasses are installed on board ships primarily for handling and securing the anchor and chain used for anchoring the ship and for handling anchor chain used for towing the ship. Most windlasses have capstans or gypsy heads for handling line in mooring and warping operations.

Windlasses can be located on the stern of the ship for stern anchoring, but are usually located in the bow of the ship for handling bower anchors. Windlasses also handle bottom-mounted braided fluke anchors (keel anchors) used on submarines (stern) and some surface ships (bow).

Landing ships capable of beaching have a separate anchor winch to handle the stern anchor used for retracting from the beach.

Two general types of windlasses are installed on naval ships. They are the vertical shaft and the horizontal shaft types. See figures 4-10 and 4-11. These two types are subdivided into classes, depending on the power source. These classes are electrohydraulic drive and electric drive. The essential parts of a typical windlass, regardless of its type and class, are the drive motor, wildcat, locking head, hand brake, capstan or gypsy head, and control.

Horizontal shaft windlasses are usually made as a self-contained unit with the windlass and drive motor mounted on the same bedplate. Vertical shaft windlasses have their power source located below deck with only the wildcats and capstans mounted above deck.

The windlass wildcat is a special type of drum or sprocket constructed to handle the anchor chain links. The outer surface has flats (or pockets) which engage chain links. At each end of the pockets, lugs (known as whelps) are provided, which contact the end of the flat link. A central groove in the outer surface accommodates the vertical links which are not in contact with the wildcat at any point.

Windlass wildcats have a locking head for disengaging the wildcat from its power source. The locking head permits free rotation of the wildcat when you are "paying out" the chain. Locking heads usually consist of two sliding block keys that may be shifted to key together a drive spider and the wildcat. The drive spider is keyed to the windlass's shaft, while the wildcat

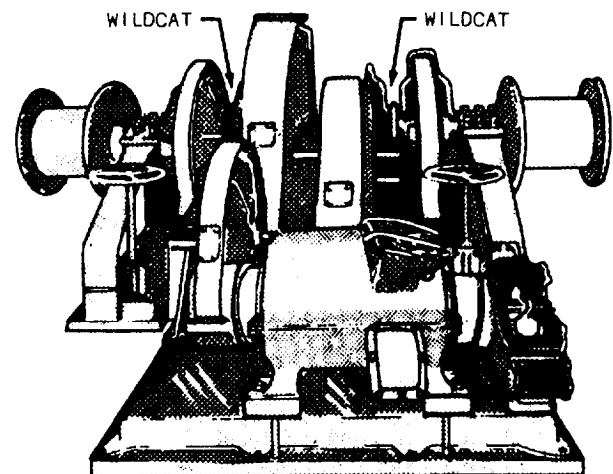

Figure 4-11.—Horizontal shaft anchor windlass.

is carried on bearings and is free to rotate, except when the locking head keys are engaged or when the wildcat's brake is set.

Each wildcat has an externally contracting flat hand brake operated by a handwheel. This brake may be used to hold the anchor and chain and to control the speed of descent when the anchor and chain are payed out.

Capstan and gypsy heads fitted on windlasses are keyed to the drive shaft and rotate when the windlass power source is turning. When using the heads, apply the wildcat hand brake, then disengage the wildcat locking head. The heads will now operate independently of the wildcats. When the wildcats are used, however, the capstan heads will always rotate.

Letting Go

When anchoring and weighing anchor, the ship's first lieutenant is in charge on the forecastle. Aboard most ships, the first lieutenant's assistant is the ship's Boatswain or Chief Boatswain's Mate.

The Boatswain's Mate in charge of the anchor detail musters the detail and makes sure all necessary gear is ready and available for use.

The exact procedure may vary for making the anchor ready for letting go, but the following tasks must be performed. The windlass is tested, the anchor in the hawse is freed, the anchor is walked out if anchoring is in deep water or if the bottom is rocky; the brake is set; and the wildcat is disengaged. All but one stopper is taken off and the anchor buoy line is shackled to the chafing chain or pendant.

The chain locker is checked for loose gear that may become wedged in the chain pipes or come flying out, endangering personnel on deck. An order then is given to stand clear of the chain. For obvious reasons, it is urgent that all hands obey this order!

At the command "STAND BY" the brake is released and two Seamen—one with a sledgehammer or maul—take stations at the stopper outboard side of the chain. When the command "LET GO" is given, one Seaman pulls the pin from the stopper tongue.

The Seaman with the maul knocks the bail off the tongue of the pelican hook and steps clear. As soon as the Seaman is clear, the brake is fully released. If for some reason the stopper does not fall clear, the chain can still be controlled by the brake.

The Seaman tending the anchor buoy tosses it over the side and the jack is two-blocked (hoisted all the way up). On the signal bridge, the anchor ball is hoisted.

The anchor buoy indicates the actual position of the anchor to which it is attached by floating above it. The buoys are painted a distinctive color; green for the starboard anchor, red for the port anchor, and white for the stern anchor.

If an anchor buoy floats on the surface, it is said to be "watching." An anchor buoy may fail to watch because its line is too short or the line is fouled in the chain. Before anchoring, the line attaching the buoy to the anchor should be adjusted to a length that is a couple of fathoms greater than the depth of the water at anchorage. This extra length allows for slight fouling, tide variations, or the sinking of the anchor in mud, which might cause the actual depth to be greater than that shown on the navigational chart being used. The anchor buoy and line must be laid up along, and outboard of, the lifelines. It should be put overboard, well clear of the ship the instant the anchor is let go.

On ships with power assist hand brakes, the power assist mechanism must be adjusted so when the brake is applied, the chain will not jump off the wildcat when it comes to a stop.

An anchor buoy is a valuable time-saver in locating an anchor lost in weighing or one that is slipped in an emergency. Slipping an anchor happens when unexpected circumstances do not permit time to weigh anchor.

As soon as the anchor hits bottom the brake is set so the chain will not pile on it. As the ship gains sternway, the brake is released to lay the chain out evenly on the bottom and to control any running movement of the chain.

As each chain marking passes the wildcat, the report "(Number) FATHOM ON DECK" is made to the conning officer on the bridge. The direction the chain is tending is indicated by pointing the arm and/or reporting "CHAIN TENDING (number) O'CLOCK."

If the chain tends around the stem, the situation is reported to the bridge. The chain must be allowed to run freely or the sharp bend around the stem may damage a link. Detachable links are particularly susceptible to damage in this regard.

If the anchor chain starts to get near the sonar dome, this situation is reported to the bridge, because anchor chain rubbing against the sonar dome can cause serious damage to it.

When the desired scope of chain is out, the conning officer gives the order "PASS THE STOPPERS." The brake is set and the stoppers are applied and evened up, the brake is taken off, and the chain is slacked between the windlass and stopper. The brake is set, and the wildcat is left disengaged. Before securing, all gear is picked up and stowed.

Weighing Anchor

When you are weighing anchor, the same gear must be available on the forecastle as for anchoring. In addition, there is a grapnel (a small four-armed anchor) used to retrieve the anchor buoy. A hose is rigged to wash mud from the anchor and the chain. The windlass is energized and tested, and then the wildcat is engaged. The brake is then released and the wildcat is tested. The brake is set, and all stoppers but one are cast off. When ready, the report "READY TO HEAVE IN" is made to the bridge.

On the command "HEAVE AROUND," the brake is taken off and the chain is heaved in enough to take the strain off the stopper. The stopper is then cast off and heaving is resumed. Reports are made to the bridge periodically on the direction the chain is tending, the amount of chain remaining out, and the degree of strain on the chain. If the command were "HEAVE AROUND TO SHORT STAY" the chain would be heaved in just short of breaking out the anchor (pulling the anchor loose from the bottom). When the chain is at short stay, it is reported to the bridge. On the command "HEAVE AROUND AND UP," start heaving. When the flukes have broken out, and the crown still rests on the bottom, the report "ANCHOR IS UP AND DOWN" is made. When the anchor is free of the bottom, it is said to be "AWEIGH" and is so reported. At this time the jack and anchor ball are hauled down and the ship is legally underway. When the anchor comes into view and its condition can be noted, the report "ANCHOR IN SIGHT, CLEAR (or FOUL) ANCHOR" is made. The anchor is reported as housed when the shank is in the hawsepipe and the flukes are against the ship's side. The anchor buoy is recovered as soon as possible, and a report is made to the bridge when the anchor buoy is on board. The anchor again is made ready for letting go and kept that way until the anchor detail is told to secure it after the ship is outside the harbor or channel.

To secure the anchor for sea, set the brake, then pass the stoppers and even them. Take the brake off, then slacken the chain between the wildcat and the stopper. The brake is set and the wildcat is disengaged. To prevent water from entering the chain locker, secure buckler plates over the chain pipes for those ships with open decks.

Stowing Chain

As the chain comes aboard, it passes along the deck, on metal flash plates, around the wildcat, and down into the chain locker. The chain goes into a locker as shown in figure 4-12. The bitter end is secured to a pad eye (ring) on the bulkhead of the chain locker.

All chain lockers on Navy ships are of the self-stowing type. However, when working small chain, at least two Seaman will be assigned to guard against any possible pileup in the chain locker. The chain can be kept from piling up by pushing any accumulation over with a length of 2 by 4 lumber.

Securing

A stockless type anchor is housed in the hawsepipe as shown in figure 4-12, and it is secured by passing the stoppers. The anchor must be drawn taut in the hawsepipe by the outboard stopper to prevent the flukes from banging the sides. Stoppers are attached to the chain by straddling a link with the tongue and strong back of the pelican hook. The bail is then closed on the pelican hook. The toggle that keeps the pelican hook closed must then be inserted in the tongue of the pelican hook and the lanyard secured around the bail to prevent the toggle pin from coming out. The turn buckles must be adjusted so each stopper will take an equal strain.

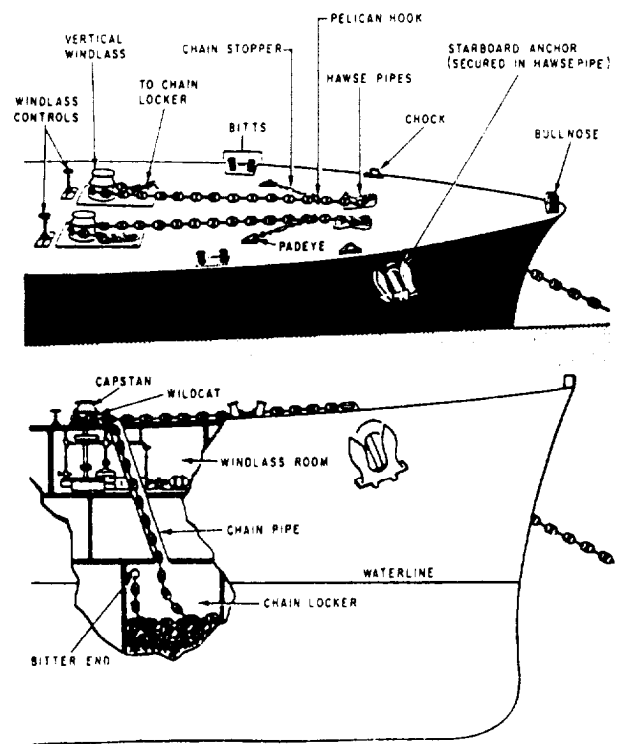

Figure 4-12.—Stowage of chain.

CAPSTANS

Capstans are mounted on deck to ease the handling of large, heavy mooring lines and wires. These capstans may be separate machinery units or part of the anchor windlass. The capstan's spool-shaped drum keeps the lines from slipping, especially when wet.

Most capstans are electrically driven. Depending on the class of ship and its size, capstans may be located any place on the deck, but they are usually found on the forecastle and fantail.

HEAVING LINE

A heaving line is a light line used to get a hawser ashore when mooring a ship to the dock or in passing a heavy line for any purpose. One end of the heaving line is fitted with a monkey fist to assist in getting distance when heaving. After making the heave, the other end of the heaving line is bent to the hawser with a bowline. The heaving line is coiled carefully with about two-thirds of the coil held in the right (casting) hand and the rest in the left hand.

In heaving, the right arm should be held straight, and the line in the left hand allowed to run out freely. Frequently the problem in not getting a long heave is that the coil in the left hand is not arranged clearly for running. Prewetting the line is done to improve distance and handling. To become proficient in heaving, you must practice frequently. Every Seaman should practice making casts. A poor cast is always a reflection on the ability of the Seaman.

BOAT DAVITS

LEARNING OBJECTIVE: List and explain the different types of boat davits and the safety devices.

A boat davit is a device that is designed specifically for handling a ship's boat or boats. The boat davit is designed to handle the ship's boats from the stowed position, through the lowering and hoisting evolutions, and returning the boat to stowage.

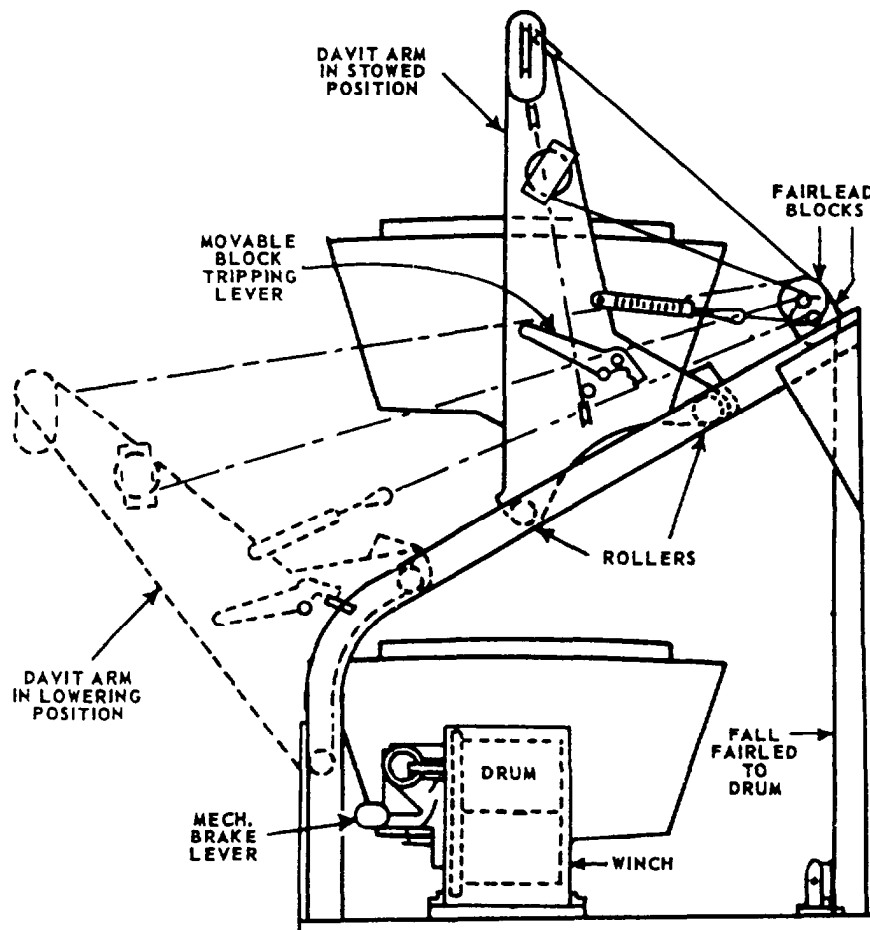

Figure 4-13.—Trackway gravity davit.

The typical boat davit system is made up of five major subsystems. These subsystems are the electrical system, the winch system, the boat davit arms and sheaves system, the boat falls system, and the stowage system. The primary function of the davit arm, (or arms, as applicable) is to swing out the boat from the inboard position to a point outboard of the ship's side from which the boat may be lowered. The reverse of this process occurs when the boat is hoisted. Hoisting operations are controlled by the winch and boat falls from which a hoisting hook (or hooks) is (are) suspended. The number of hoisting hooks is dependant on whether the boat davit is the single arm or double arm configuration. The falls lead from the boat davit winch (the source of power), through the boat davit arms and sheaves to the hoisting hooks. A drum type winch is used with all boat davits having a wire rope fall or falls. A gypsy type winch is used with some boat davits when the falls are synthetic fiber rope. Boat davits are either of gravity or mechanical type.

A gravity boat davit requires only the force of gravity to move a boat suspended from the hooks at the inboard position to the outboard position and down to the water. The lowering evolution from the inboard position to the water is controlled at the winch through the boat falls. The winch's manual brake controls the boat's descent speed and prevents the davit arms from slamming into the outboard stops. The manual brake is also used to stop the boat before it reaches the water to

allow the coxswain to start the boat's engines. The power to hoist the boat from the water is provided by the winch. Handcranks can be attached to the winch for hoisting the boat by hand if a loss of electrical power should make it necessary. Gravity boat davits are either of the overhead suspended, trackway, pivoted, or pivoted link type, and may be of the single or double arm configurations. Figure 4-13 depicts the typical operation of a trackway gravity boat davit.

The mechanical boat davit requires the application of an external force to move the boat and davit arms from the inboard to the outboard position in preparation for lowering the boat to the water. Movement of the boat outboard with mechanical boat davits is not under control of the boat falls. Mechanical boat davits of the pivot sheath screw (occasionally called crescent) and radial designs are no longer being built for Navy ships. However, these older design mechanical boat davits are still used on some Navy and merchant vessels. The newest type of a mechanical boat davit being used by the Navy is the slewing arm boat davit. This boat davit is often called the SLAD and it handles the rescue boat called a rigid inflatable boat (RIB).

The double-link davit generally handles two boats. The double-link configuration can handle both the larger and heavier types of boats (officer/personnel, utility cargo) as well as the lighter weight rescue boat. A double-link pivoted gravity davit is shown in figure 4-14.

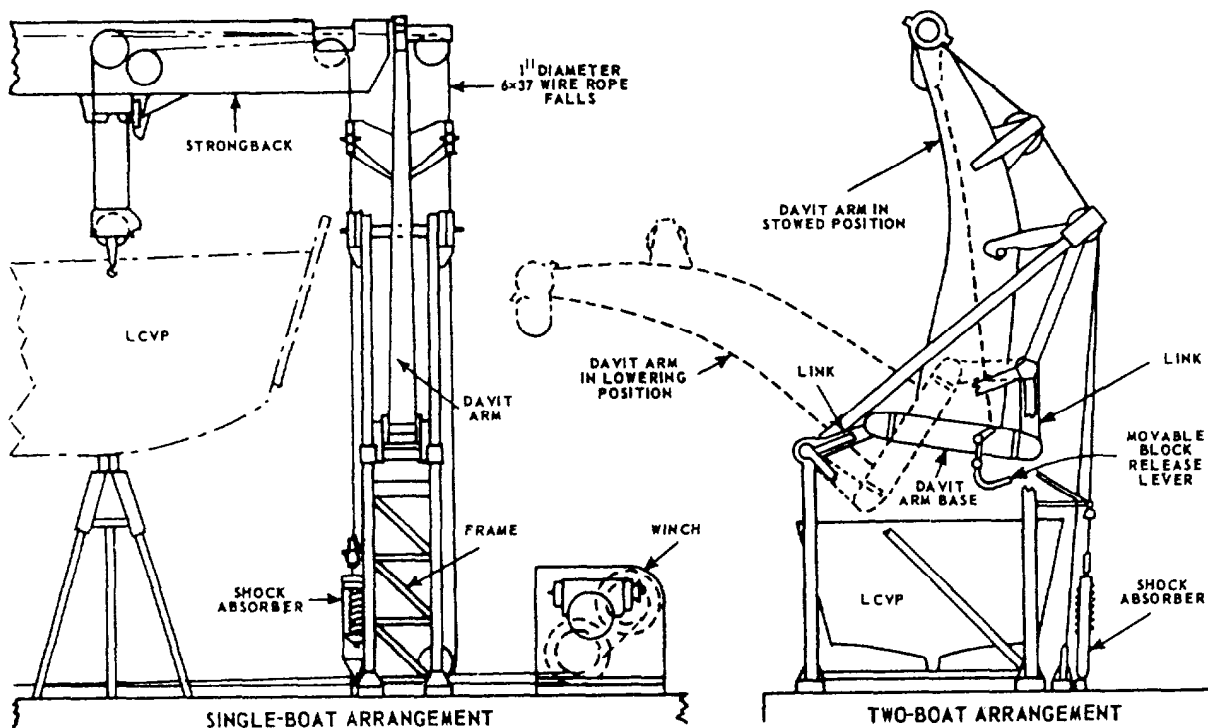

Figure 4-14.—Double-link pivoted gravity davit.

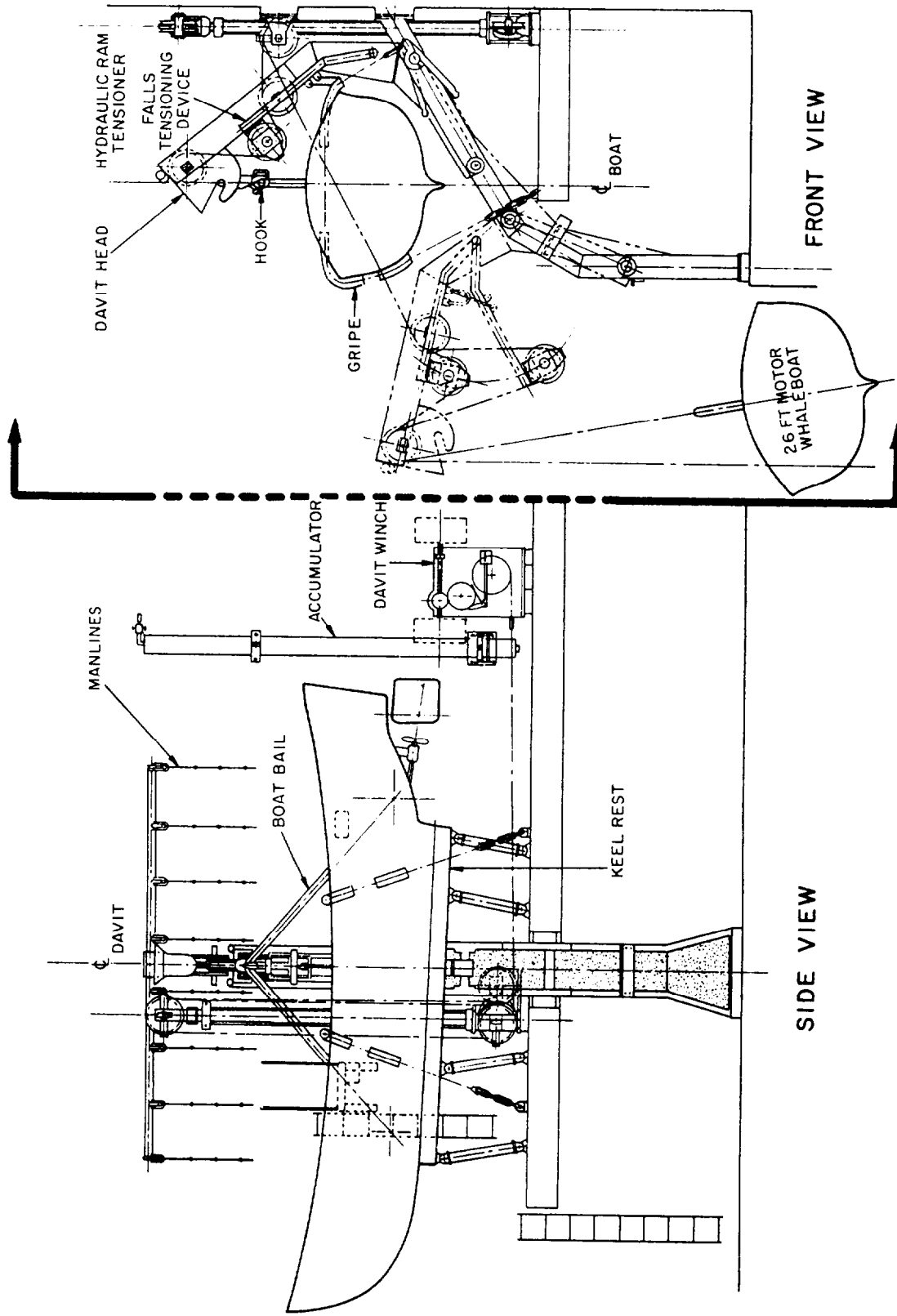

Figure 4-15.-Single-arm trackway gravity davit.

The single arm boat davit handles only one boat, normally the lightweight rescue boat. It uses a special boat bail or sling to enable lifting at a single point. Hence, the relatively dangerous and time-consuming process of threading two hooks through bow and stem hoisting rings is eliminated. A typical single arm trackway boat davit arrangement is shown in figure 4-15.

BOAT DAVIT TYPES AND CONFIGURATIONS

There are seven design types of boat davits currently in use for handling boats aboard Naval ships. Each of these design types comes in several different configurations. Table 4-1 shows a list of the design types and configurations.

Overhead Suspended Boat Davits

Overhead suspended boat davits consists of two sets of sheaves mounted beneath a sponson or other overhang. The boat falls are reeved through the sheaves and connected to a double drum boat winch for power hoisting. The boat is stowed suspended from hooks directly over the water. The boat is lowered using only

the force of gravity and it is hoisted by the winch. Overhead suspended boat davits are used mainly on aircraft carriers and amphibious helicopter landing ships.

Pivoted Boat Davits

Pivot boat davits can be either the single-arm configuration or the double-arm configuration. The arm(s) pivot(s) around a single axis to move inboard or outboard. Pivot single-arm boat davits handle one boat. Pivot double-arm boat davits may handle one or more boats, depending on the application. Depending on the configuration, one boat may be stowed gripped in against the arms, or two boats may be stowed one over the other between the arms. Depending on the model, the boat davit arms are connected by either a strongback or a span wire. The single-arm configuration and the double-arm configuration are gravity boat davits.

Pivoted Link Boat Davits

The pivoted link boat davits are double-arm boat davits designed to lower, to hoist, and to store one or more boats. Two davit frames, one forward and one aft, are mounted to the ship's deck. Each frame supports a davit arm. The arms are connected to the frames by pivoting links. The arms then pivot around the multiple axes of the links to move the boat(s) inboard and outboard (fig 4-14). Depending on the configuration, one boat may be stowed gripped in against the arms, or two boats may be stowed one over the other between the arms. Depending on the model, the boat davit arms are connected together by either a strongback or a span wire. Pivoted link boat davits are gravity boat davits.

Slewing Boat Davits

Slewing boat davits have a single arm mounted on a pedestal, which in turn is mounted to the ship. The arm slew rotates about the vertical axis of the pedestal to move the boat inboard and outboard. This boat davit design, commonly called a slewing arm davit (SLAD), is used to handle rigid inflatable boats (RIB). The boat or boats are stowed on the deck of the ship next to the pedestal. The slewing boat davit is electrically powered and it is also a mechanical boat davit.

Trackway Boat Davits

A trackway boat davit can be either of single arm or double arm configuration. The trackway boat davits may handle one or more boats depending on its

Table 4-1.—Boat davit and configurations

DAVIT DESIGN TYPE	CONFIGURATION
OVERHEAD SUSPENDED	Double arm, fixed
PIVOTED	Single arm Double arm, span wire Double arm, strongback
PIVOTED LINK	Double arm, span wire Double arm, strongback
PIVOTED SHEATH SCREW	Double arm, span wire
RADIAL	Double arm
SLEWING	Single arm, standard Single arm, non-magnetic Single arm, overhead
TRACKWAY	Single arm Double arm, span wire Double arm, strongback

application. Each arm is mounted on rollers which run on an inclined trackway that is mounted on the deck. The incline on the trackway(s) is sufficient for gravity to cause the boat and arm(s) to move down the trackway(s) from the inboard position to the outboard position so the boat may be lowered into the water. Depending on the model, the boat davit arms are connected by either a strongback or a span wire (fig. 4-13 and 4-15). Trackway boat davits are gravity boat davits.

BOAT DAVIT SAFETY DEVICES

Boat davit installations have various safety and protective devices. These safety devices are visual, electrical, and mechanical in nature. We will describe some of the safety devices in the following paragraphs.

Safe Hoisting Position Stripes

Safe hoisting position stripes are usually red in color and 2 inches wide, and they are used as a visual aid for the boat davit operator. They are painted on the davit frame and the davit arm(s) at a minimum distance of 8 inches from either the two-blocked position or the solidly compressed position of the buffer spring. They indicate when the electric motor must be de-energized during hoisting to avoid a two-blocked condition. A two-blocked condition is where the boat fall(s) are prevented from movement either by design or obstruction. Continued hoisting against a two-blocked condition

could result in over stressing or failure of davit components.

Slewing Position Stripes

Slewing position stripes are used for a slewing boat davit (SLAD) as a visual aid to indicate when to de-energize the electric motor during slewing. There are three stripes, usually red in color and 2 inches wide. One stripe is painted on the arm and two stripes are painted on the pedestal. One of the two pedestal stripes indicates when the arm is slewed to the STOW position and the other indicates when the arm is slewed to the LOWERING position.

Emergency Disconnect Switch

The emergency disconnect switch is located at the boat davit operation station to allow the operator to interrupt power to the motor. It is used in an emergency situation to prevent a two-blocked condition if another control component fails to function properly.

Double Break Feature

Electrical contacts subjected to momentary jogging service are prone to sticking or welding. This can cause uncontrolled operation of the winch. The double break feature is the arrangement of two independent contactors in the supply leads to protect against this danger. When the motor power supply is interrupted by the master switch the supply leads are opened in two places by contactors which are not interlocked. In the

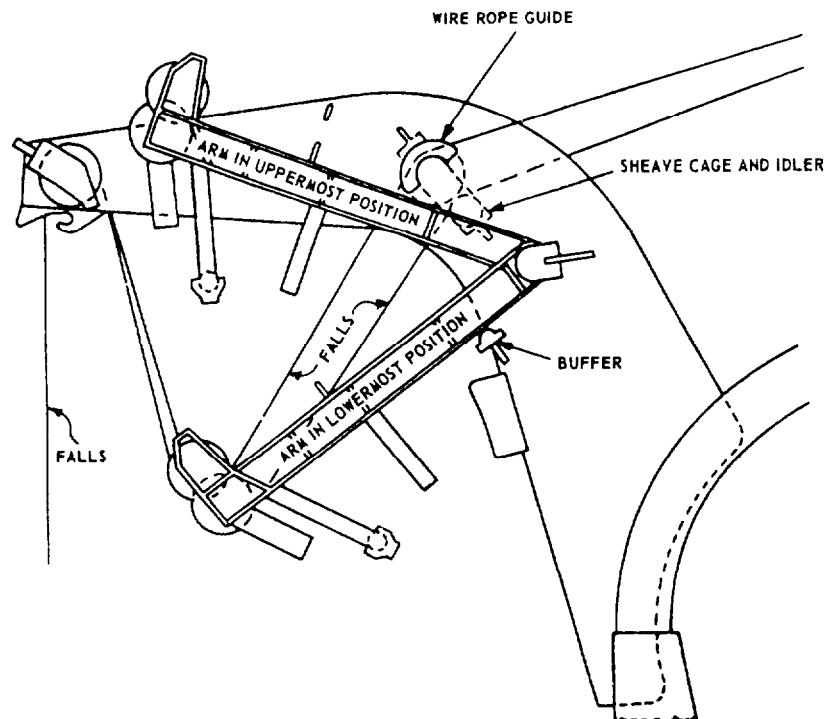

Figure 4-16.—Fall tensioning device.

event that the master switch is moved to OFF and one contactor sticks, the second contactor should interrupt the power.

Fall Tensioning Device

The fall tensioning device keeps the hook above the heads of the boat crew before boat hookup and after release. This reduces the danger to the boat and to the crew from a swinging hook assembly. When the hook is cast off during launching, the fall tensioning device counter-weighted sheave causes the hook to rise clear of the boat and crew. Figure 4-16 is an example of a fall tensioning device.

Fluid Brake

A fluid brake is attached to the output shaft of the electric clutch on the SLAD hoist drive motor. The purpose of this fluid brake is to regulate the speed of a descending boat thus preventing any damage to the equipment or personnel.

Safety Handcranks

Safety handcranks include an overriding mechanism. This mechanism functions in such a manner that, if

a winch motor is energized while the winch is being manually cranked, no force is exerted on the crank handle from the winch side and thus prevents back drive. This device may be used in place of handcrank electrical interlock switches. For the SLAD, the formlock clutch prevents the back drive of slewing and hoist handcranks and thus both drives can be power driven with the handcranks being engaged.

DECK FITTINGS

LEARNING OBJECTIVE: Recognize common deck fittings found aboard ships and explain their purpose.

Deck fittings are the various devices attached to the hull that assist in handling the ship.

The most common fittings are found around the weather decks. A brief description of some common deck fittings (fig. 4-17) follows.

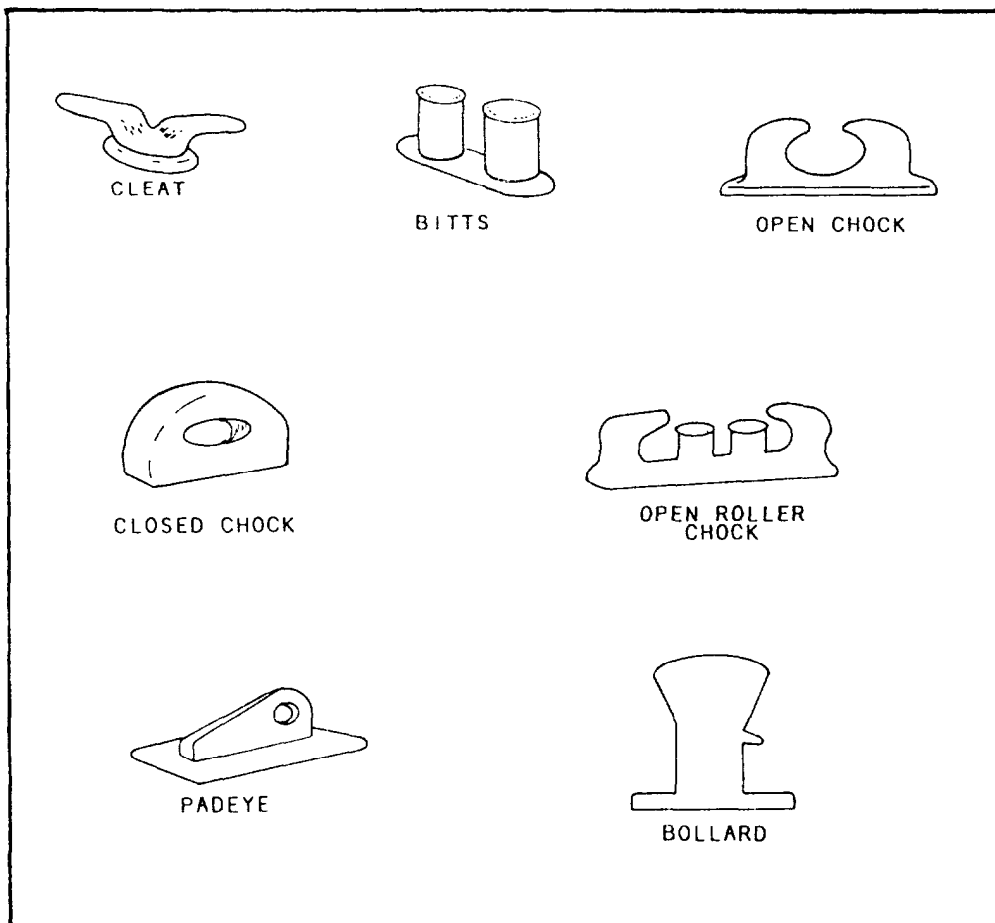

Figure 4-17.--Various deck fittings.

CLEATS

A *cleat* is a device consisting of a double-ended pair of projecting horns used for belaying a line or wire.

BITTS

Bitts are heavy vertical cylinders, usually arranged in pairs, used for *making fast* lines that have been led through chocks. The upper end of a bitt is either larger than the lower end or is fitted with a lip to keep lines from slipping off accidentally. As bitts are required to take very heavy loads, extra frames are worked into their foundations to distribute the strain. Usually there is a set of bitts forward and aft of each chock. When constructed in pairs, each bitt is sometimes called a barrel.

CHOCKS

A *chock* is a heavy fitting with smooth surfaces through which mooring lines are led. Mooring lines are run from bitts on deck through chocks to bollards on a pier when the ship is moored. There are three types of chocks: An open chock is a mooring chock that is open at the top. A closed chock is a mooring chock, closed by an arch of metal across the top. A roller chock is a mooring chock that contains a roller for reducing friction.

PAD EYES

A *pad eye* is a plate with an eye attached, welded to the deck to distribute the strain over a large area and to which a block can be hooked or shackled. A pad eye is also used in towing operations.

BOLLARDS

A *bollard* is a strong cylindrical upright on a pier, over which the eye (or bight) of a ship's mooring line is placed.

ACCOMMODATION LADDERS

LEARNING OBJECTIVES: Define accommodation ladder. Identify the construction and use of the accommodation ladder.

Ships are fitted with accommodation ladders that can be rigged and lowered over the side. These ladders provide a convenient means for boarding or leaving an

anchored vessel. Some accommodation ladders can be modified for use on a pier or barge.

Large Navy ships have forward and after accommodation ladders, two on the starboard side and two on the port. If more than one ladder is rigged, the forward accommodation ladder is the quarterdeck and reserved for officers and ceremonies. The after ladder is used by work details and crew liberty parties. Some aircraft carriers are fitted with an accommodation ladder in their transom (on the stern of the ship).

The accommodation ladder, figure 4-18, has an upper and lower platform that is connected by the ladder and supported by either a chain or wire bridle and bail hanging by a pendant. Another method is the use of a metal bail shaped like an elongated upside down letter U which holds the ladder by a pendant rigged to the side of the ship or from a J-Bar davit.

The lower platform of the accommodation ladder has additional parts that must be rigged. An H-Frame equipped with fenders is rigged to the outboard side of the lower platform. This H-Frame is where boats can come alongside to pick up or discharge passengers. The inboard side of the lower platform is fitted with ports called shoes, that when rigged hold the ladder in the proper position off the side of the ship. The shoes have pads attached to their ends to help prevent damage to the ship or the ladder. The lower platform also has turnbuckles, and in some cases, pendants to restrict the fore and aft movement of the ladder.

The upper platform is supported by a brace known as a wishbone. A single-sheave block is attached to the underside of the forward outboard corner of the upper platform. A line is rigged through this block which acts as a sea painter to keep a boat alongside in position with the accommodation ladder. A toggle between the strands of the line prevents the line from running up into the block and becoming inaccessible to a boat.

There may be some accommodation ladders made of steel still in service, but for ease of handling, the Navy has changed to aluminum.

When an accommodation ladder is secured for sea, everything is rigged in, disassembled in most cases, and stowed in brackets either on the rail or along a section of the superstructure. All of the smaller portable parts are stowed in a gear locker close to where the ladder is rigged. Care must be taken so that this essential gear is not carried off for other purposes.

When an accommodation ladder is rigged, the first you must do is follow the ship's plans. You should make

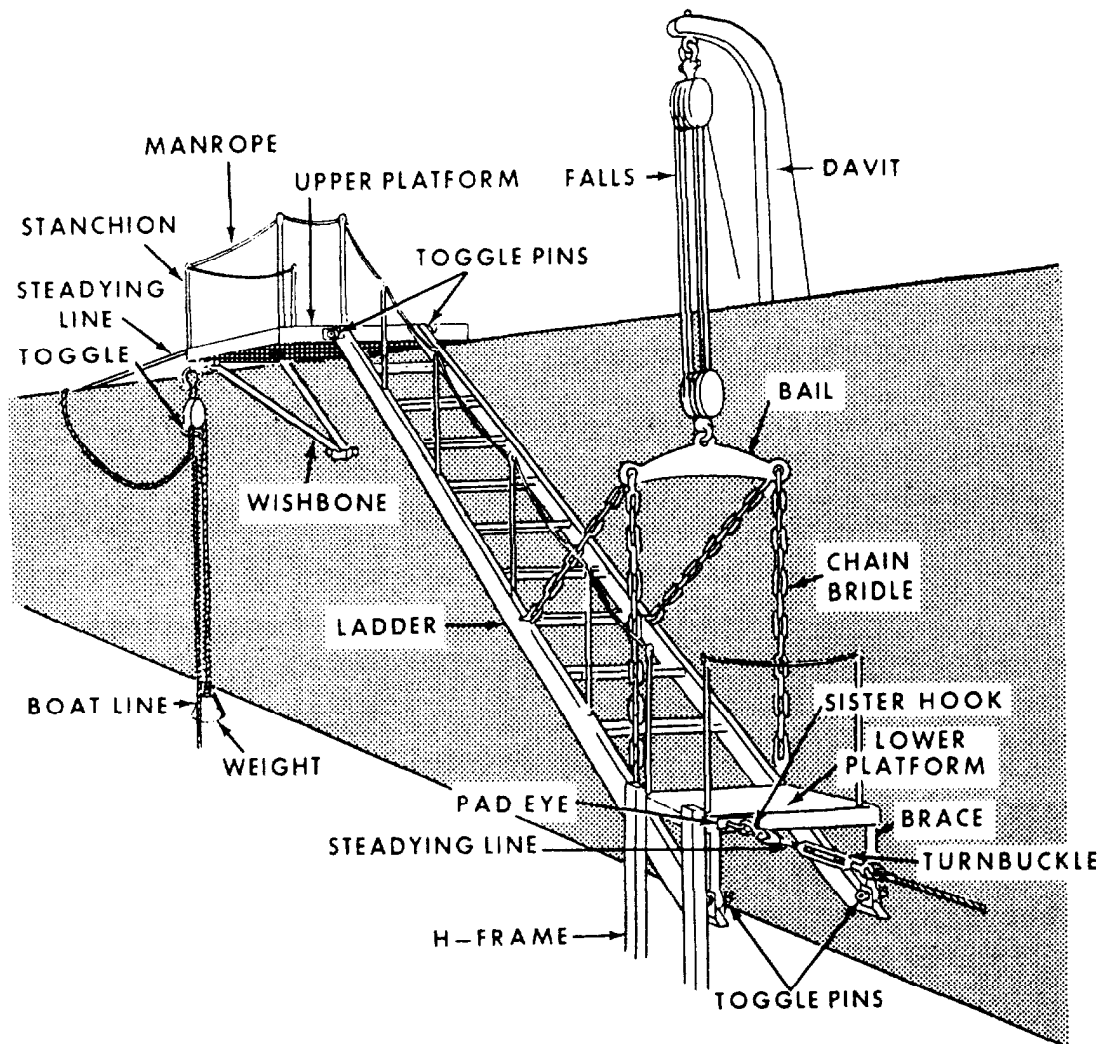

Figure 4-18.—Parts of accommodation ladder.

sure all parts are on hand and that the toggle pins and bolts are seized with short sections of wire and attached to the ladder to prevent them from being lost over the ship's side.

The next step is to rig the upper platform. Remember to be careful in lining up the brackets when you are engaging the bolts. Many a hand injury has occurred from careless or unsupervised rigging operations.

Once the upper platform is in place, the next step is to secure the ladder to it. This is an area where the ship's plans and design must be followed. Some ships have the ladder stowed against the rail. To attach this type ladder, you use a series of outriggers (arms swung out from the ship) to lay the ladder on and seat the ladder to the upper and lower platforms. On ships that do not have outriggers, the J-Bar davit can be used to support the ladder over the side to attach it to the upper platform. Another method is to use a ladder that engages pad eyes

on the side of the ship and holds them in place by a two-fold rigged to the superstructure.

Depending on the type and class of the ship, rigging procedures will vary. Again, the ship's rigging plans must be used.

Now that the ladder is attached to the upper platform, the lower platform and the H-Frame must be rigged. It is easier if the H-Frame is rigged to the lower platform while it is still on deck. Once the H-Frame and the lower platform are rigged on deck they must be worked over the side to attach to the ladder. This can be done by using the falls from the J-Bar davit or from some other suitable attachment point.

The ladder is now taking shape and nearly ready to lower. Rig the bail and bridle to the ladder and attach the wire pendant between the bail and the J-Bar davit. On some ships, the pendant is rigged between the bail and a pad eye alongside the ship.

With this equipage rigged, we are ready to lower the ladder. Attach the falls to a sling on the lower platform. Make sure the hook is moused so the sling does not fall out of the hook.

If outriggers were used or if pad eyes and two-fold are holding the ladder, we must lay back on the falls to take the weight of the ladder off of them. Swing the outriggers in and or disengage the ladder from the pad eyes and remove the two-fold. The weight of the ladder is now on the falls attached to the lower platform and the attachment points of the upper platform.

The accommodation ladder should be lowered smoothly and it must always be controlled in its descent. As the ladder lowers into position, the pendant will extend itself between the attachment point and the bail. Keep an eye on the bridle and bail to make sure that they are not fouled as the ladder is lowered. The weight of the ladder will shift to the pendant, the bail, and the bridle when the ladder is in its down position. A crew member must now go down the ladder and rig the shoes. Shoes on an accommodation ladder are posts that slide out from the lower platform and act as fenders to keep the ladder in the proper position off the side of the ship. The shoes are secured by pins set in from the top of the lower platform into pre-drilled holes in the shoes. Turnbuckles are now rigged from the lower platform to the side of the ship. They prevent the fore and aft movement of the ladder.

While this is being done, another sailor rigs the boat line. The boat line is nothing more than a block rigged under the forward outboard corner of the upper platform. It acts as a sea painter to help boats making landing at the ladder.

The rails of the ladder are not set up and secured into position.

Remember that in some of these rigging procedures, personnel will be working outside of lifelines and over the side of the ship. It is absolutely necessary for these personnel to be in life jackets and safety harnesses with proper safety lines rigged. While underway, the Commanding Officer must give permission before anyone can work over the side.

Pneumatic fenders are now lowered over the side of the ship. They are positioned fore and aft of the accommodation ladder to protect the ladder and the ship from boats coming alongside.

When you complete the steps in rigging the accommodation ladder, you are ready to receive boats alongside. One of the marks of a smart efficient ship,

when going to anchorage is not only the proper use of her ground tackle but the timely manner in which she has her accommodation ladders and boat boom rigged.

As previously mentioned, some accommodation ladders can be modified for use on a pier or barge. To do this, the lower platform and the H-Frame are left off, and a roller and a safety step are installed at the bottom of the ladder, as shown in figure 4-19. The safety step assembly eliminates the foot hazard caused by the ladder roller.

BOAT BOOMS

*LEARNING OBJECTIVES: Define boat boom.
Describe the purpose of the boat boom.*

Ships that are at anchor, or are moored to a buoy, rig out their boat booms for the purpose of mooring their boats well clear of the side. This method of securing is known as "hauling out to the boom." Forward booms are called lower booms, after booms are called quarter booms.

The boat boom (fig. 4-20) is a spar secured by a gooseneck to a pin on the side of the ship, which allows free motion fore and aft. The outboard end of the boom hangs from a wire and tackle combination called the topping lift. Nylon or wire rope forward and after guys control the fore-and-aft motion.

A strong line called a guess-warp leads from well forward on the ship, out through a block in the end of the boom, and ends in a metal thimble through which boats can Reeve their bow lines. A toggle is seized between strands of the guess-warp above the thimble to keep it from running up (out of reach) when a boat lets go. One or more Jacob's ladders from the boom permit boat crews to come aboard.

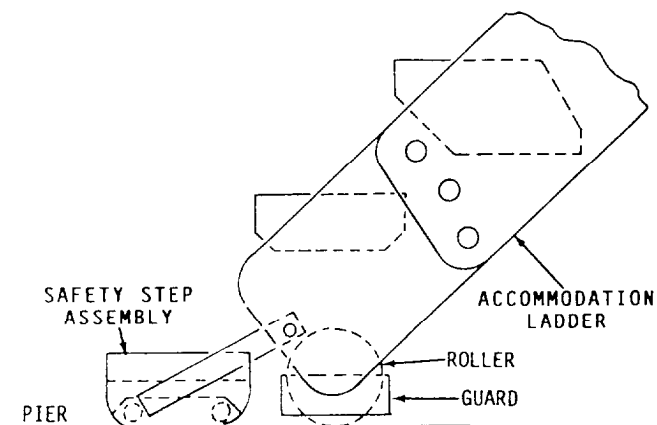

Figure 4-19.—Accommodation ladder rigged to pier.

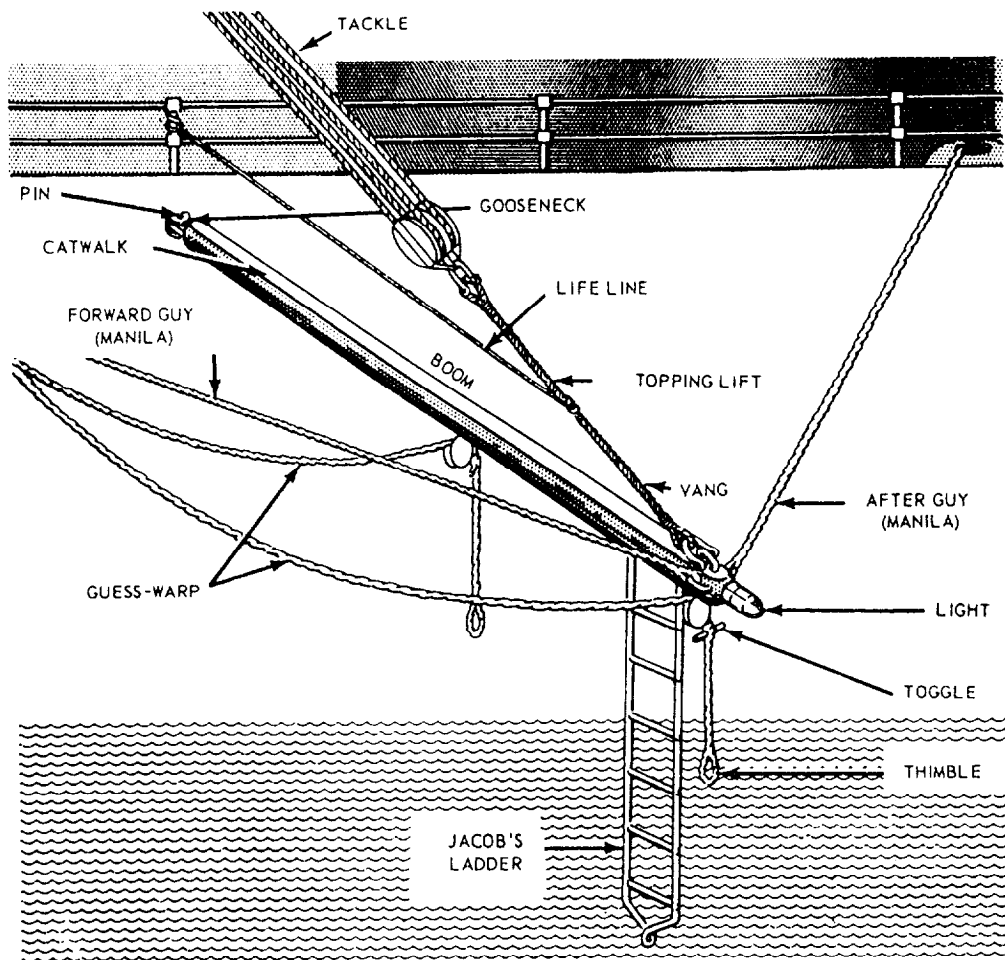

Figure 4-20.—Parts of a boat boom.

Rigging the boat boom is a simple matter. Ladder, guys, and guess-warp are attached, and the guys are led out fore and aft. The after guy usually is marked at the point where it secures, then it is made fast at this point first. Next, the boom is started out by a shove with a boat hook, or anything else suitable, and the forward guy is heaved around on until the after guy is taut and then secured.

You will find it easier to climb the Jacob's ladder hand over hand from one side, as you would climb a rope, instead of facing it as you would a rigid ladder. Be certain you have a good hold on the lifeline before you transfer from the ladder to the boom, and keep hold of it as you come in to the side. If you fall off, you are as likely to injure yourself against the boat as you are by falling in the water. Always wear a properly secured life jacket when traveling over the boom. You may be a good swimmer, but you cannot swim if you are unconscious.

In making fast to the guess-warp by the boat painter, always reeve the painter through the thimble and secure its end back in the boat, so you will not have

to get at the thimble to let go. Always have the boat ride to a long lead on the painter. The shorter the painter, the more up and down the strain, and the more the boat's weight will come on the boom as it dives down on a swell.

CARGO-HANDLING EQUIPMENT

LEARNING OBJECTIVE: Describe cargo-handling equipment, including winches and hand signals used in the cargo handling evolution.

The Navy is always studying and experimenting to make all phases of cargo handling faster, safer, easier, and more economical. There are many ships designed for specific tasks that have rigs peculiar to those types. The following discussion on cargo-handling equipment is brief. For more detailed information, consult *Boatswain's Mate, Volume 1*, NAVEDTRA 10101, or *Naval Ships' Technical Manual*, chapter 573. Figure 4-21 shows you the typical rig for the yard-and-stay

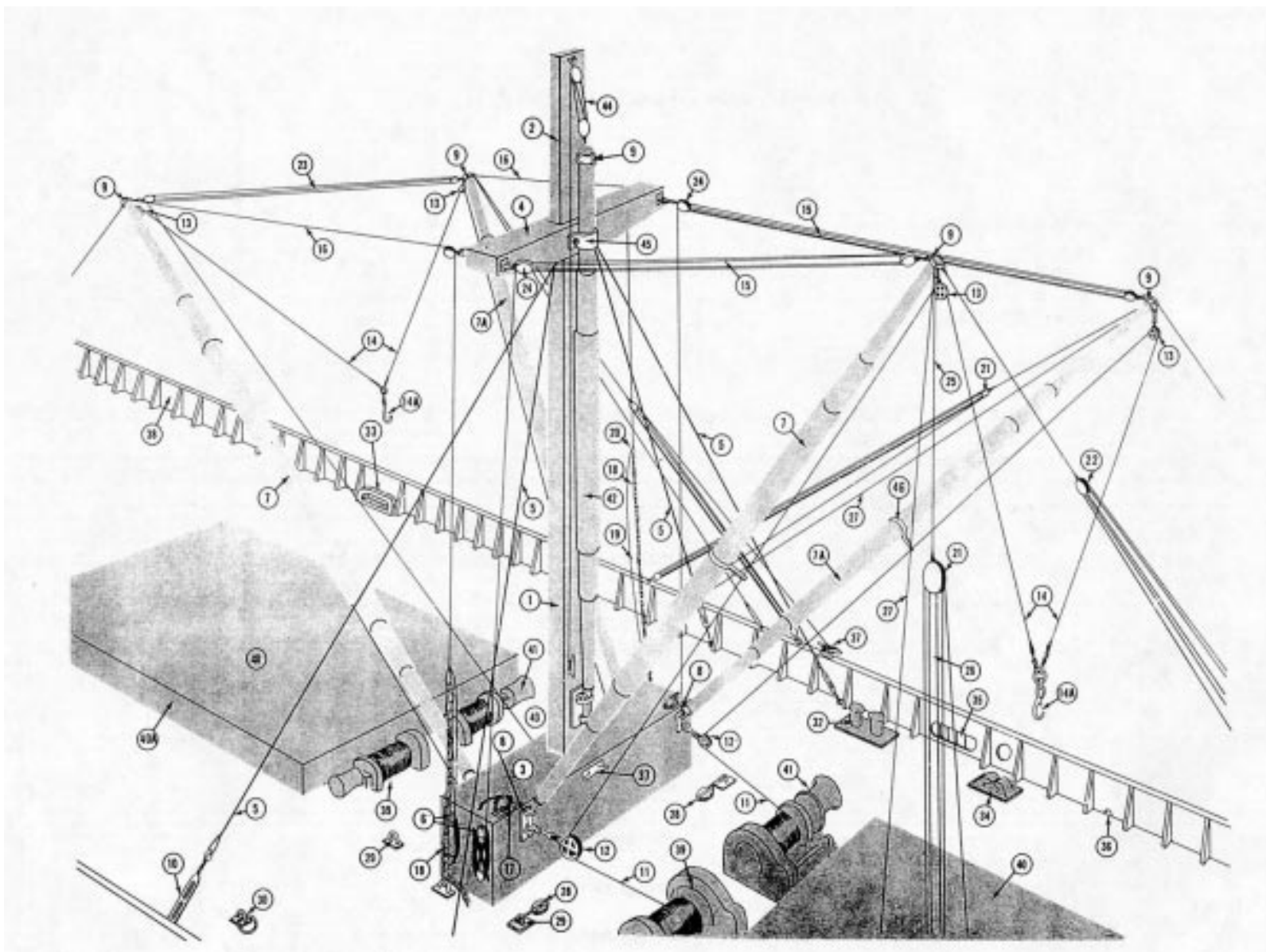

Figure 4-21.-Yard-and-stay rig.

1. Mast
2. Topmast
3. Mast table
4. Crosstree
5. Shroud
6. Topping lift cleat
7. Hatchboom
- 7A. Yard boom
8. Gooseneck
9. Linkband
10. Turnbuckle
11. Cargo whip
12. Heel block
13. Head block
14. Cargo whips
- 14A. Cargo hook
15. Topping lift (multiple)
16. Topping lift (single)
17. Stopper chain
18. Bull chain
19. Bull line
20. Flounder
21. Outboard guy
22. Inboard guy
23. Midship (schooner, lazy) guy
24. Topping lift block
25. Guy pendant
26. Guy tackle
27. Preventer
28. Snatch block
29. Pad eye
30. Pad eye and ringbolt
31. Shackle
32. Bitts
33. Closed chock
34. Open chock
35. Freeing port
36. Scupper
37. Cleat
38. Bulwark
39. Hatch winch
40. Cargo hatch
- 40A. Hatch coaming
41. Yard winch
42. Jumbo boom
43. Gooseneck and step of jumbo boom
44. Breasting-up tackle
45. Boom gate collar
46. Slack-wire fairlead

Figure 4-21.—Yard-and-stay rig-Continued.

method of cargo handling. Two booms are used. One boom plumbs the hatch, and it is called the hatch boom. The other boom is called the yard boom, and it is rigged over the side so that it plumbs the dock or pier. Booms are spotted in working position by hauling on the guys. The cargo whips coming from the hatch and the yard winches are run through heel and head blocks and are shackled to the same cargo hook. The outboard guys and preventers are balanced in proportion to the load and in the working position of the boom.

Cargo whips are shackled to the cargo hook, and a load is picked. The load is raised until the angle formed by the whips is about 120 degrees. The outboard guys and preventers are equalized by easing off the guy tackles. As outboard guys and preventers are being equalized, all slack is taken in on the inboard or midships guys. It is a good practice, when originally spotting the booms, to swing them slightly wider than desired. When guys and preventers are equalized, the booms will move inboard into position.

The winch controls for the yard and stay are usually located so that one person can operate both winches and have an unrestricted view of the hold. When you are moving a load from the hold to the pier, the yard whip is kept slack as the hatch whip hoists the load from the hold and clear of the hatch coaming. Then, when you heave around on the yard whip and pay out on the hatch whip, the load is moved across the deck and over the side. When the load is plumbed under the yard boom, the hatch whip is slacked off and the yard whip lowers the load to the pier.

Because topping and lowering booms are dangerous evolutions, safety is always emphasized. Personnel are cautioned to stay away from under the booms while handling operations are in progress. The deck should be kept as clear as possible of obstructions. A clean deck provides the safest working condition.

As a Seaman, you should always watch for discrepancies while a load is being moved, and keep every part of the rig under constant observation. No unnecessary personnel should be in the area. Those involved with the operation must stay alert.

CARGO WINCHES

Winches designed for handling cargo consist of a bedplate and side frames upon which are mounted a horizontal drum shaft, drum and/or gypsy head(s), reduction gearing, and usually the motor that drives the winch. Figure 4-22 illustrates the components of a typical winch. *Drum winches* are those with drums on

which the rope is wound for raising, lowering, or pulling the loads. *Gypsy winches* have one or two horizontally mounted gypsy heads around which turns of line can be taken. *Combination winches* are drum winches with shafts extended to take gypsy heads on either side or on both sides. Preceding every winch operation, operators should review all general operating and safety instructions, among which are the following:

1. Always inspect the area around the winch, and make sure there is a dry, safe place for the winch operator to stand.
2. Inspect the rigging, making certain that the standing rigging is taut and that the running rigging is not fouled.
3. Inspect the equipment, making sure the clutch levers are locked in place.

Although the engineering department is responsible for maintaining winches, the winch operator and the petty officer in charge must make certain that the required maintenance is actually performed.

Coordination is essential for good winch operation. After sufficient practice, winch operators should be able to pick a draft from the hold and deposit it on the pier in one smooth, constant motion. However, during the early stage of training, the draft should be handled with three distinct movements: hoisting, moving, and lowering. In hoisting, one winch supports the entire load and the other maintains slack. When the draft is clear of the rail or coaming, it is carried across the deck by both winches. This is called moving. When a draft is in position to be lowered, the other winch supports the entire load and the first whip is slacked. It is vital that the right amount of slack be left in the nonworking whip during the hoisting and lowering phases of the load's cycle. If the whip is kept too tight, the draft will strike against the side of the ship or the coaming of the hatch. If the whip is allowed excess slack, loose turns will pile up on the drum of the winch, and these must be rewound before operations are resumed.

When cargo is being hoisted or lowered, swinging should be avoided if possible. A wildly swinging draft often results in damaged cargo and endangers the lives of personnel working in the hold, on deck, or on the pier. Swinging can usually be prevented in the hold or on the pier by dragging or touching the draft until it is directly under the head of the boom before hoisting. Occasionally, a draft will start to swing athwartships while being carried across the deck. This swinging must be stopped before the load can be landed. It can be done easily with a little practice. When moving outboard, wait

until the draft is at the highest point of its arc swinging outboard, then slack the hatch whip quickly so the slings supporting the draft assume the usual perpendicular position. For safety reasons, you should practice stopping the swing of a draft with an empty pallet.

At least two steadying lines should be attached to heavy or unwieldy loads. These should be handled by personnel in the hold until the load is hoisted above the coaming, then passed simultaneously to personnel on deck.

HAND SIGNALS

Hand signals to winch or crane operators by Signalmen provide continuous communications. The approved hand signals, shown in figure 4-23, are found in the *Naval Ships' Technical Manual* (NSTM). These

hand signals are used when you are conducting crane operations afloat. Additional hand signals may be necessary for specific commands; however, no signal used should conflict with, or alter the meaning of, the hand signals contained in the *Naval Ships' Technical Manual*.

UNDERWAY REPLENISHMENT (UNREP)

LEARNING OBJECTIVES: Define underway replenishment (UNREP). Explain the various equipment used during an underway replenishment.

Underway replenishment (UNREP) is a broad term applied to all methods of transferring fuel, munitions,

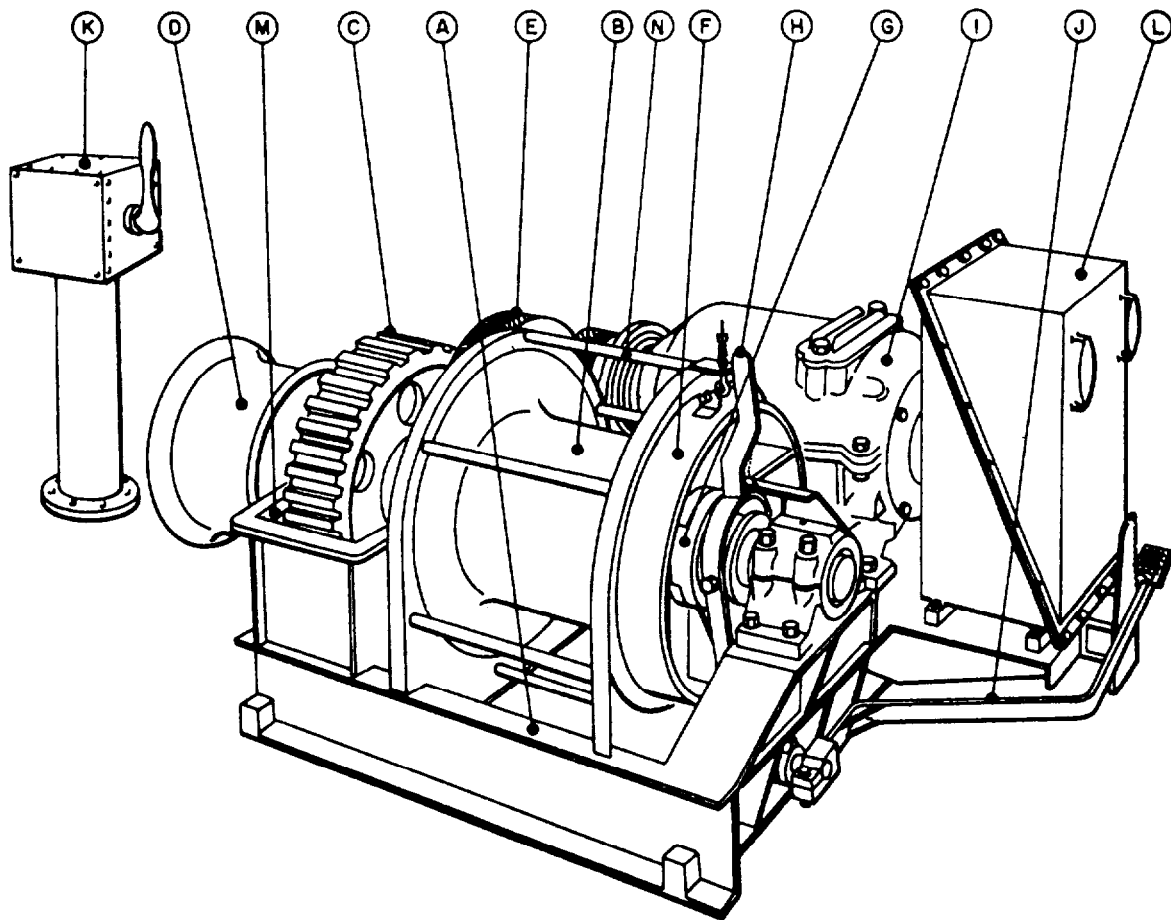

- | | | |
|----------------------|---------------------|-------------------|
| A. Bedplate | F. Drum brake | K. Speed control |
| B. Drum | G. Drum clutch | L. Electric brake |
| C. Drum gear | H. Clutch lever | M. Oil bath |
| D. Gypsy head | I. Drive motor | N. Rope guard |
| E. Reduction gearing | J. Drum brake lever | |

Figure 4-22.—A typical winch.

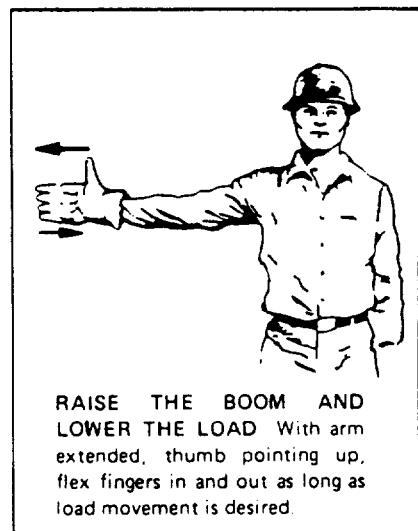
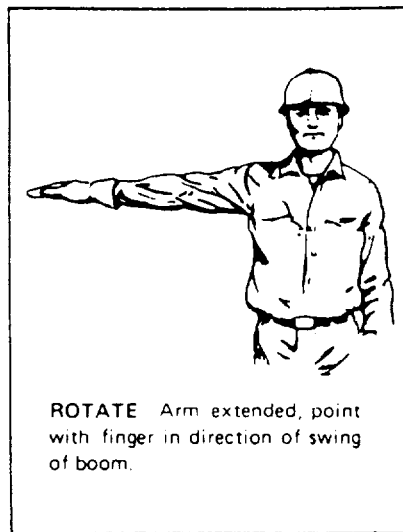
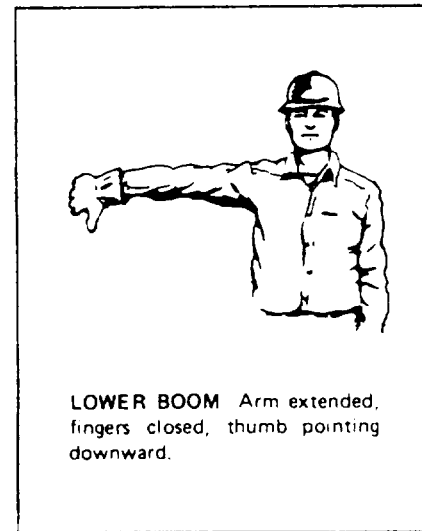
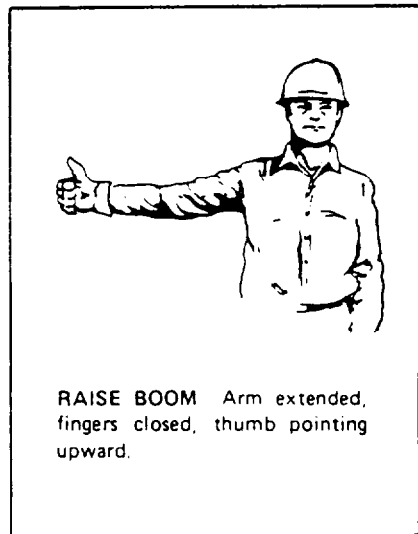
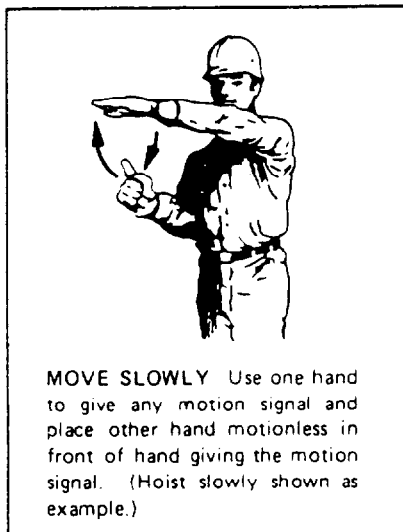
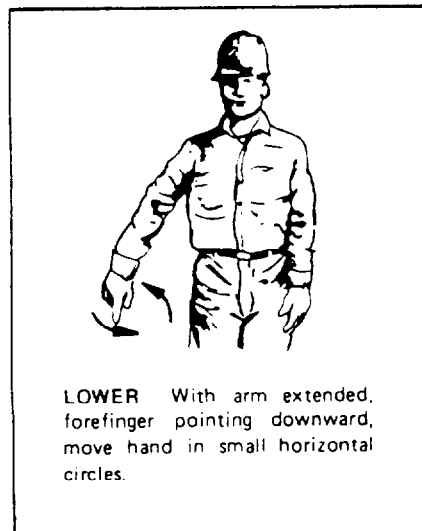
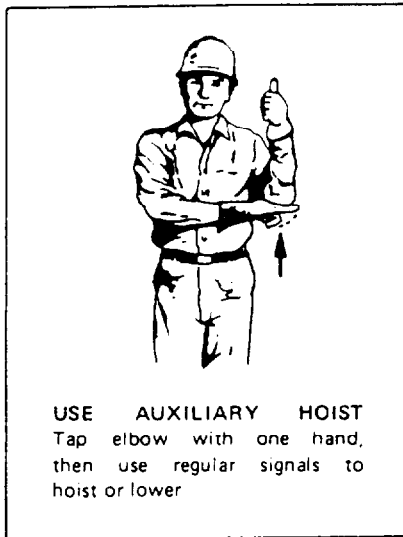
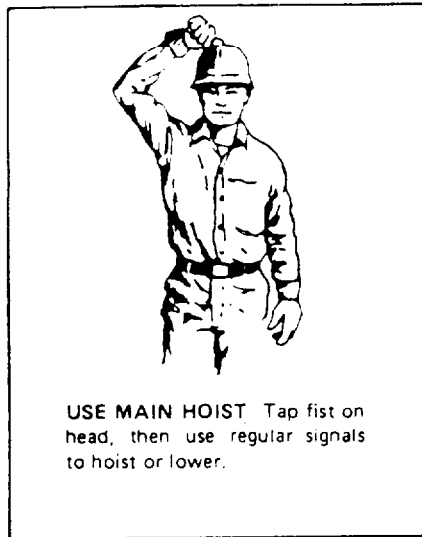

Figure 4-23.—Hand signals used in crane operations, sheet 1.

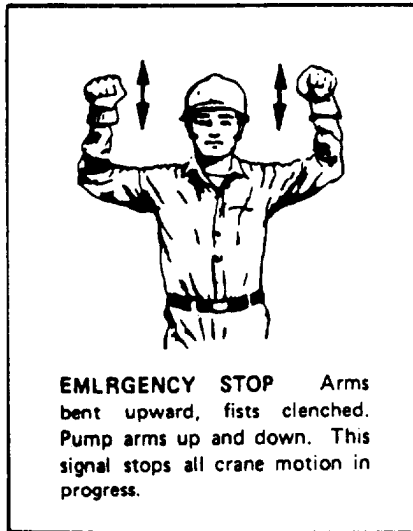
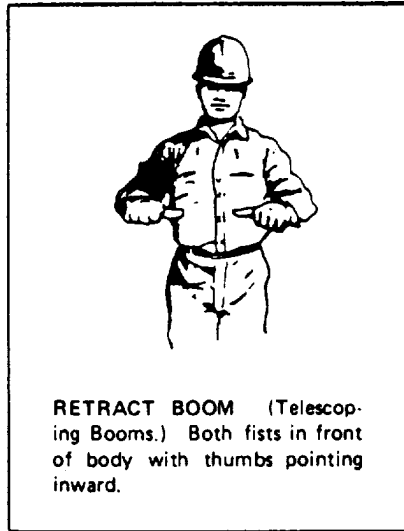
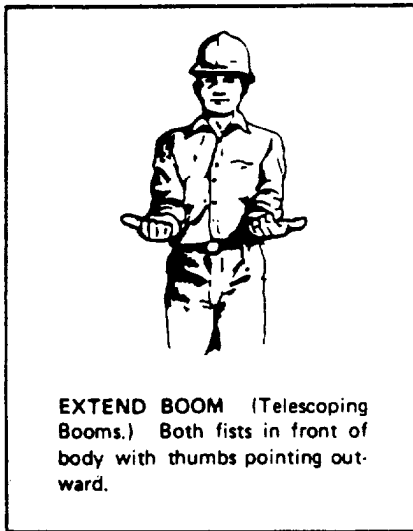
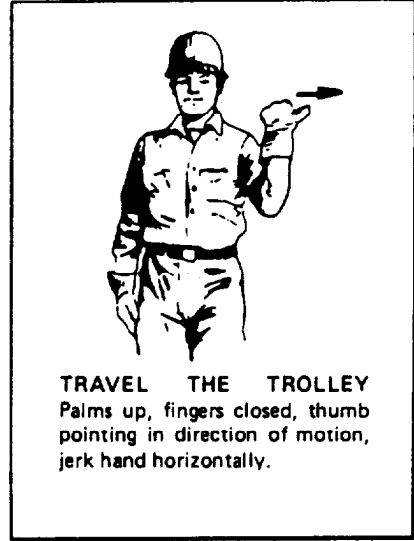
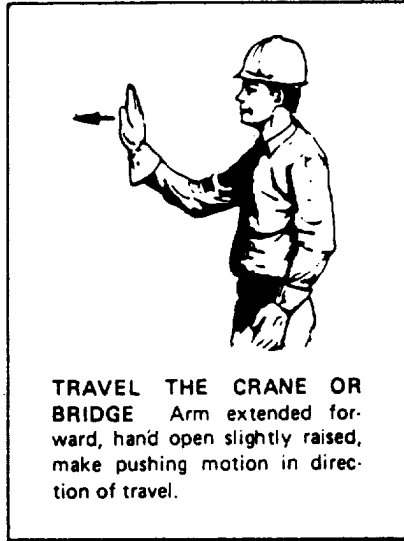
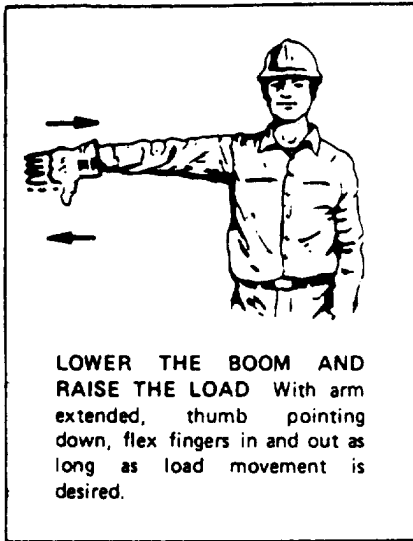

Figure 4-23.—Hand signals used in crane operations, sheet 2.

supplies, and personnel from one vessel to another while ships are underway. The term *replenishment at sea*, formerly used in this sense, applies to all methods except those for fueling at sea.

Before the techniques of UNREP were developed, a ship that ran low on fuel, supplies, or ammunition had to return to port, or the fleet had to lie to while the ship was partially replenished by small boats. If several or all the ships were in need, the whole fleet had to return to port. The disadvantages were obvious. The effectiveness of a fleet was reduced by every ship that had to leave, and a ship or small group of ships detached from a fleet were in greater danger of being sunk or captured. A fleet lying to in order to replenish was more vulnerable to attack, and a fleet heading back to port left the way open for an enemy fleet to accomplish its mission. With underway replenishment, a whole fleet can be resupplied, rearmed, and refueled in a matter of hours while proceeding on its mission.

The first significant replenishment operation ever performed at sea by the U.S. Navy was in 1899, when the U.S. Navy collier *Marcellus*, a coal carrier, while towing USS *Massachusetts*, transferred coal to it. Since that time, many methods have been tried and abandoned. Those methods described in this section have been adopted as the most feasible and are currently used in the fleet.

The equipment and procedures used in replenishment operations are only briefly described in this section. They are discussed in more detail in *Boatswain's Mate, Volume 1*, NAVEDTRA 10101; and "Replenishment at Sea," NWP 14 (series).

Two general methods of UNREP are used: connected replenishment (CONREP) and vertical replenishment (VERTREP). They may be used singly or at the same time. In CONREP, two or more ships steam side by side, and the hoses and lines used to transfer the fuel, ammunition, supplies, and personnel connect the ships. VERTREP is carried out by helicopters. The ships may be in the proximity or miles apart, depending on the tactical situation and the amount of cargo to be transferred. CONREP concerns two processes: refueling and resupply. In fueling at sea (FAS), fuel is pumped from a delivering ship that may be a replenishment oiler (AOR), oiler (AO), fast combat support ship (AOE), or a large combat ship. Other replenishment ships, such as the combat store ship (AFS) and the ammunition ship (AE), can deliver lesser amounts of fuel, since their primary purpose is to deliver solid cargo (supplies and ammunition) by the methods now referred to as replenishment at sea (RAS).

The most common refueling rigs are the span-wire and the close-in rigs. Both rigs, and other variations, will be discussed in more detail later in this chapter. The span-wire rig has several variations: single hose, double hose, and probe. The span wire may be either tensioned or untensioned. Tensioning the span wire is accomplished by a ram tensioner. A tensioned span wire or highline, as it is called in RAS, is also used when the standard tensioned replenishment alongside method (STREAM) of transfer is used. STREAM transfer consists of an all-tensioned rig, highline, outhaul, and inhaul. The method of fairleading the outhaul is a traveling standard UNREP fixture (traveling SURF). The SURF is used with two STREAM rigs, the regular traveling SURF and the SURF traveling-actuated remotely (STAR) rig. STREAM with tension highline has an alternate method when the UNREP ship experiences difficulties with the outhaul winch. This rig is called a Burton outhaul and is sent to ships having Burton whip capabilities.

Other common methods of RAS include manila highline, Burton housefall, and modified housefall.

You must be familiar with the various equipments and procedures used during replenishment. Making rough sketches of the equipment and labeling the various parts might help you to remember the various rigs.

The illustrations in this section, and the procedures described, are representative only. For example, many items of rigging, such as guys and preventers, have been omitted from illustrations for clarity. Consult NWP 14 and the *Underway Replenishment Hardware and Equipment Manual* to determine the details of rigging and the personnel and tools required for each rigging situation. Ship's plans show rigging details, while the ship SORM fixes responsibility for the various functions to be performed.

The *Underway Replenishment Hardware and Equipment Manual* provides a catalog of the equipment used in the transfer of solid cargo and bulk fluids, and a description of the methods used in UNREP. The manual permits the user to identify the equipment and establishes the intended use. It also makes reference to additional detailed technical information related to the configuration, operation, maintenance, safety features, installation, and procurement of UNREP equipment.

Your worth as a Seaman will be judged largely on how you conduct yourself during evolutions, such as fueling at sea. Make sure that every piece of gear required is at your station. Do not forget such things as

buckets and drip pans, rags for wiping up spilled oil, buckets of sand to spread on slippery decks, spare stops, etc.

It is the responsibility of the officer in tactical command (OTC) to select a suitable course and speed, taking into consideration the mission of the group and the condition of the sea.

Generally, the delivering ship takes station, and the receiving ship maneuvers to come alongside and maintain position during the operation. When replenishing large CVs, however, replenishment ships may complete the final phase of the approach, because of obstructions

to view from the bridge of aircraft carriers. During replenishment, individual flaghoists are displayed as shown in figure 4-24.

Because of the danger of hitting aircraft on deck, CVs, LPHs LHAs, and other ships with aircraft on deck fire the shot lines to the delivering ships.

Except for the gear actually rigged on the receiving ship, such as fairlead blocks and riding lines, and for the distance line and Burton whips, the delivering ship furnishes all the equipment. An exception to this practice is when carriers and cruisers are alongside replenishment ships and personnel are to be transferred.

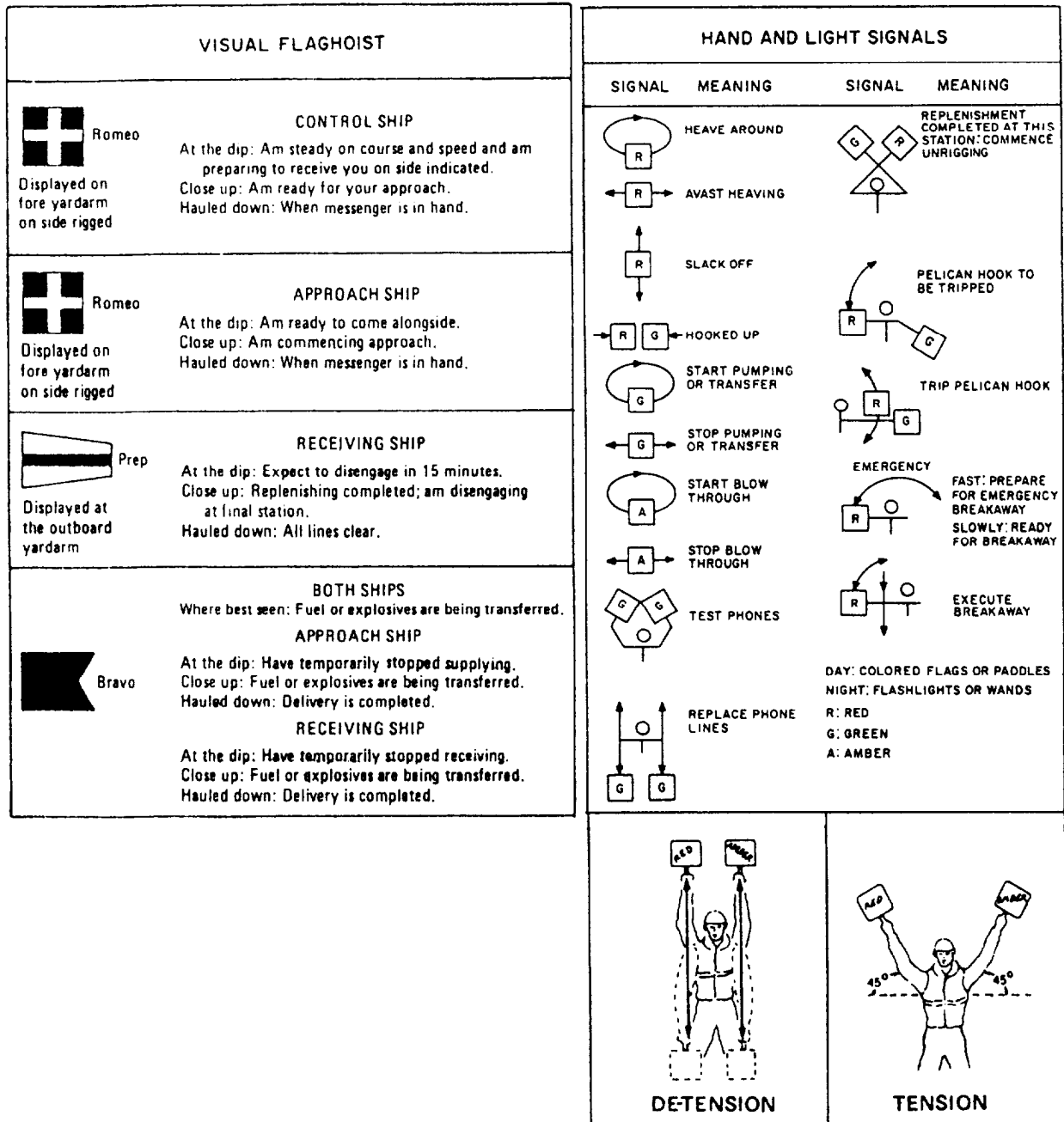

Figure 4-24.—Replenishment operations signals.

In this case, the combatants must furnish and tend the highline.

Each replenishment station has a telephone line to the corresponding station on the other ship. Necessary commands are transmitted by telephone, and a Signalmen also gives them by the hand or by light signals as shown in figure 4-24. It is a good idea to post these hand signals at the replenishment stations or, better yet, to stencil them on the backs of the paddles.

PHONE/DISTANCE LINE

The zero end of the distance line (fig. 4-25) is secured at or near the rail of the delivering ship, and the other end is hand-tended on the receiving ship. Embedded in the polypropylene distance line are the conductors for the sound-powered (S/P) telephone line, which provides the communication link between the bridges of the two ships.

A bridge-to-bridge (B/B) combination phone/distance line and station-to-station line are normally provided by the receiving ship. The line is fitted with a

double jackbox at each end labeled B/B PHONE. Markers attached to the line indicate the distance between ships, enabling conning officers to know immediately when the ship is opening or closing distance. Daylight markers (marker flags) consist of 8-inch by 10-inch numbered colored cloth, nylon-coated fabric, or painted canvas squares spaced 20 feet apart. At night, a red flashlight or red chemical light is fastened at the leading edge of each daytime marker with the exception of the blue lights indicated in figure 4-25. The zero end of the line is secured to the rail of the delivery ship at a right angle to the ship's centering in view of the conning officer. During night replenishment, the line tender keeps the conning officer informed on the distance.

Electric megaphones are used during the approach until telephones are connected. After the telephones are connected, the megaphones are the main standby method of communicating.

SOUND-POWERED TELEPHONES

Sound-powered telephones are the principle means of passing information. Although the receiving ship

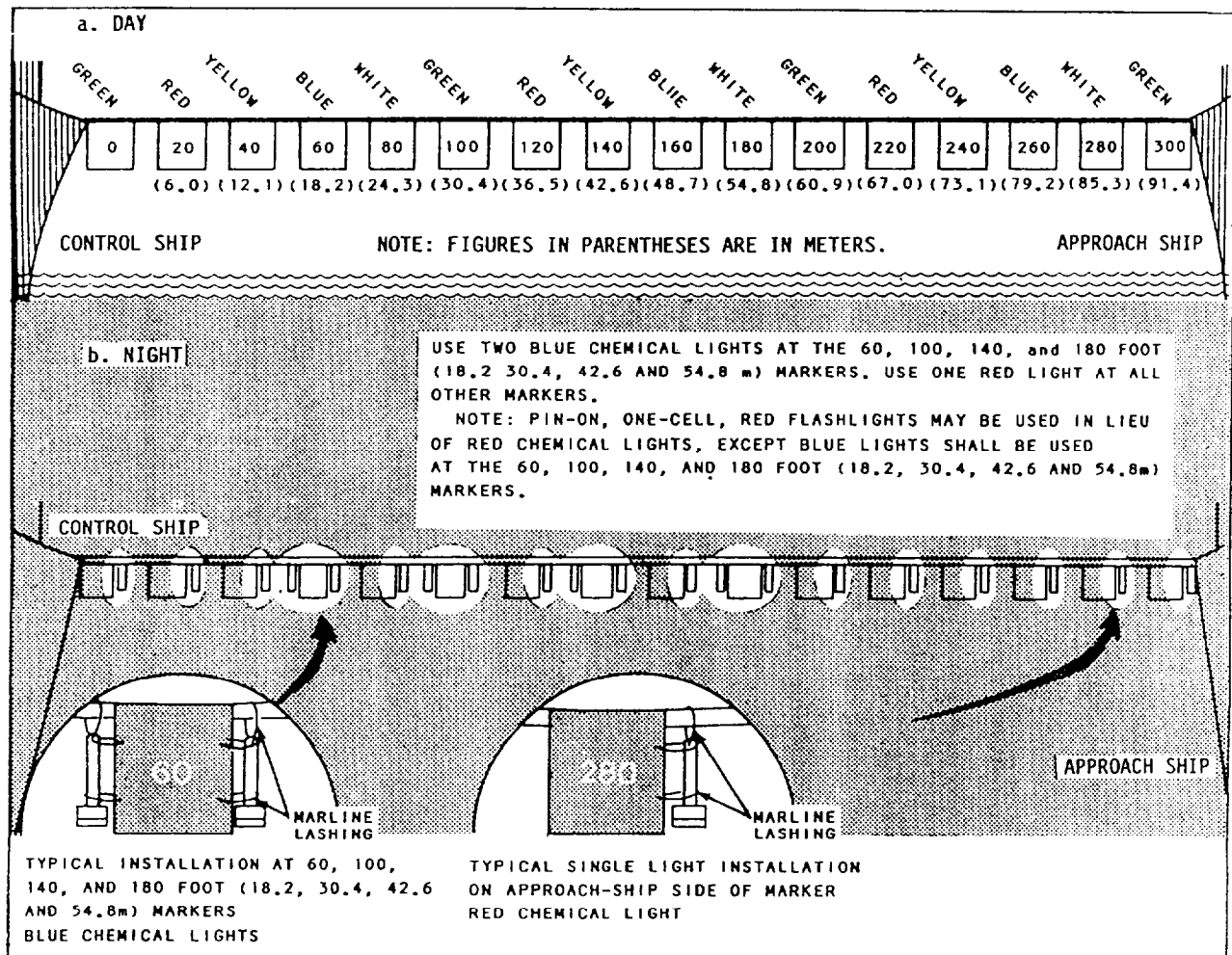

Figure 4-25.—Bridge-to-bridge phone/distance line markings.

normally provides individual telephone lines between conning stations, either ship may provide station-to-station phone lines for use between transfer stations. Talkers must ensure that telephone leads are ready to establish communications as soon as jackboxes are received aboard. To prevent injuries resulting from rapid surging of ships while they are alongside, talkers on the intership lines do not wear telephone neck straps; the telephone lines are hand-tended.

Careful attention should be given to the matter of jackbox covers. They must be secured tightly by wrapping the phone boxes in plastic bags when the telephone lines are being passed between ships. Experience shows that a replenishment-at-sea operation can be slowed by lack of attention to this small, but vital, detail. Hand paddle and light signals at replenishment stations parallel orders passed over the sound-powered telephones. During daylight, replenishment station Signalmen render hand signals with 12- by 12-inch paddles; at night, red, green, and amber flashlights or colored wands are used.

At each replenishment station both ships indicate the commodity being handled.

LINE-THROWING GEAR

Line-throwing guns or bolos are used to pass shot line between ships. Normally, this is done by the delivery ship except for carriers and other ships with aircraft on deck. The line-throwing gun fires an illuminated projectile. The bolo, which is preferred for passing the shot line in daylight, consists of about 10 ounces of lead with rounded corners. It is well padded, encased in rubber or leather, and attached to the end of a nylon shot line. A 2-inch toggle is secured to the line about 5 feet from the weight. To use the bolo, you must grasp the toggle and whirl the weight about your head several times to gain momentum before letting go. Utmost caution should be exercised when a line-throwing device is used because of the potential for possible injuries to personnel. A shot line is returned at the earliest possible time to facilitate preparation of the line for another relay, if needed.

Line-throwing gunners and bolo heavers must be well trained, and they must be outfitted in red helmets and red jerseys or red vests. Before firing or heaving the lines, the word is passed on both ships over the IMC and/or by electric megaphone (bull horn) as follows:

FIRING SHIP: "ON THE (name of receiving ship), STAND BY FOR SHOT LINES. ALL HANDS TOPSIDE TAKE COVER."

RECEIVING SHIP: "ON THE (name of own ship), STAND BY FOR SHOT LINES AT (station(s) concerned). ALL HANDS TOPSIDE TAKE COVER."

Before firing the shot, each station on the delivering ship sounds one blast on a whistle. When ready to receive the shot line, each station on the receiving ship replies with two blasts. These two signals must be sounded each time the shot line is fired. The messenger is the main line used in hauling a rig between ships.

If the delivering ship has difficulty getting its shot lines across, the receiving ship uses its own line-throwing guns when requested to do so by the delivering ship. The shot or bolo lines are used to haul over the messengers and then passed back at the earliest convenience to the ship furnishing them.

Replenishment stations are marked according to the commodity delivered or received. These station markers are shown in figure 4-26.













COMMODITY TRANSFERRED	CODE	
	DAY 3 ft ² (91.4 cm ²) BUNTING OR PAINTED AREA	NIGHT LIGHT BOX
MISSILES	INTERNATIONAL ORANGE	
AMMUNITION	GREEN	
FUEL OIL	RED	
DIESEL OIL	BLUE	
DIESEL FUEL MARINE (DFM)	RED & BLUE TRIANGLES	
JET FUEL (JP-5)	YELLOW & BLUE TRIANGLES	
WATER	WHITE	
STORES	GREEN WITH WHITE VERTICAL STRIPES	
PERSONNEL AND/OR LIGHT FREIGHT	GREEN WITH WHITE LETTER "P" CENTERED	
FUEL OIL AND JP-5	RED/YELLOW & BLUE TRIANGLES	
DFM AND JP5	RED/BLUE & YELLOW/BLUE TRIANGLES	
BRIDGE-TO-BRIDGE PHONE/DISTANCE	GREEN WITH WHITE LETTER "B" CENTERED	

Figure 4-26.—Station markers.

A complete set of working tools and repair equipment must be maintained in a location that can be readily accessed by transfer station personnel. Tools and equipment should be inventoried and checked for proper operation before each replenishment. Each transfer station should maintain, as a part of station equipment, a listing of all items (tools, spares, and so forth) that may be required to repair the station, together with the stowage location of such items.

REPLENISHMENT RIGS

LEARNING OBJECTIVE: Identify the common replenishment at sea and fueling at sea rigs.

Replenishment at sea is conducted by using a span wire to support the fuel hose rig between the two ships. The span-wire rig or close-in method may be used. The method used is determined by the type of ship delivering the fuel and the conditions under which the delivery must be made. The main difference between

the rigs is in the method of extending the hose to the receiving ship. Of the two, the span wire is preferred.

Ships not equipped to transfer by span wire must do so by the close-in method.

SPAN-WIRE METHOD

In the span-wire method of fueling at sea, the hose is carried between ships on a span wire that may be tensioned or untensioned. The untensioned span wire, normally is referred to as the conventional span-wire rig. The tensioned span-wire method is referred to as STREAM. STREAM rigs are rigged with four saddles and a hose length of approximately 300 feet. The hose hangs from trolley blocks that ride along the span wire. Saddle whips position the hose while fueling, and serve to retrieve the hose after the fueling operation is completed.

The span-wire rig (see fig. 4-27) permits ships to open out from 140 to 180 feet. Such distance is reasonably safe and makes it fairly easy to maneuver

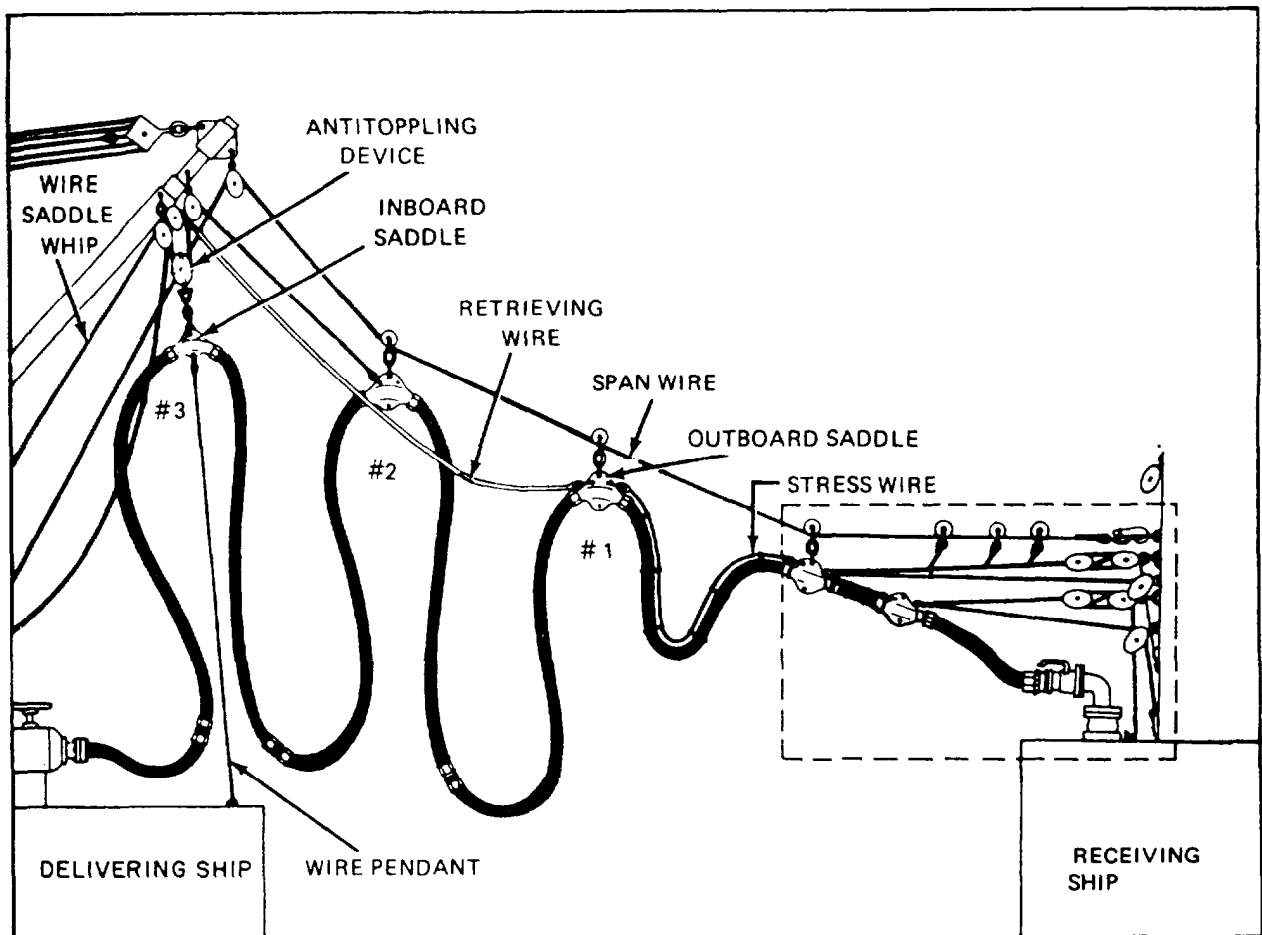

Figure 4-27.—Fuel stream, single hose with probe.

and keep station. These factors not only allow commanders a wider latitude in choosing a fueling course but also facilitate the use of antiaircraft batteries should the need arise. Additionally, the high suspension on the hose affords fair protection for it in rough weather.

Ordinarily, in the span-wire method, saddle whips and the retrieving line are of wire; but when the necessary winch drums are not available and winches with gypsy heads are available, 3 1/2-inch, double-braided nylon line may be substituted for one or more of the whips. A wire rope retrieving whip is mandatory in double-probe rigs.

CLOSE-IN METHOD

As stated before, the close-in method of fueling is used when the delivering ship is not equipped with the span-wire rig or the receiving ship does not have a pad eye strong enough to hold a span wire.

In the close-in rig, the hose is supported by whips leading from the hose saddles to booms, king posts, or other high projections on the delivering ship. When the

rig is used to fuel ships larger than destroyers, the outboard bight of hose may also be supported by an outer bight line (fig. 4-28) leading from the outboard saddle to a high point on the receiving ship. The outer bight line is passed to the receiving ship by means of the hoseline messenger.

On the receiving ship, the same preparations are made as for receiving the span-wire rig except that an additional 12- or 14-inch snatch block must be shackled to a high, convenient, and adequately tested point above where the hose will come aboard. Such other blocks as are necessary to fairlead the bight line to a winch must also be rigged. A small pendant should be reeved through this set of blocks to quickly haul the outer bight line through the blocks and to the winch. The outer bight is used to help haul the hose to the receiving ship and, once the hose is secured, is tended in the same manner as are the saddle whips.

STREAM METHOD

There are several transfer rigs used to replenish provisions and stores. Some are suitable for heavy

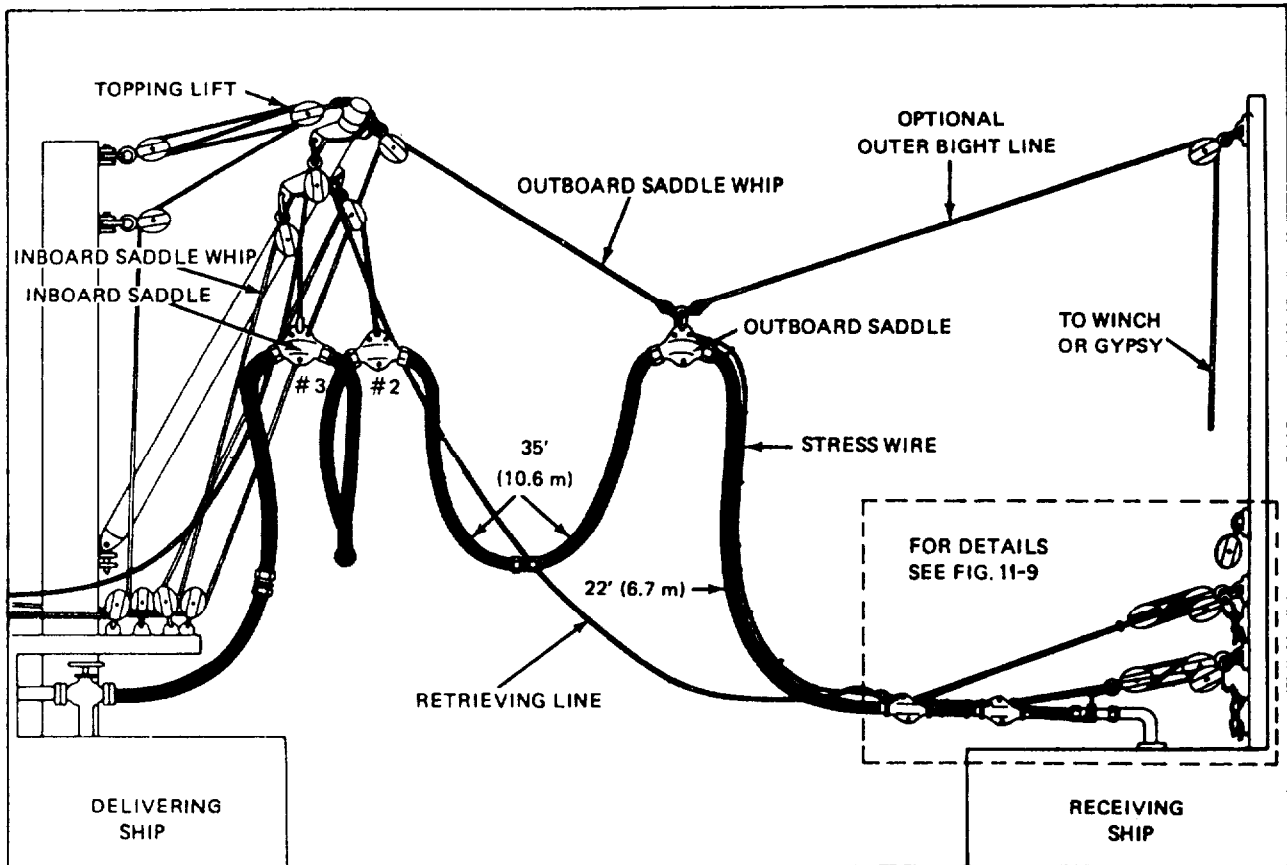

Figure 4-28.—Close-in rig.

loads, while others can be used only for light cargo or personnel transfer. Standard rigs, named here only for familiarization purposes, include the Burton, housefall, and highline.

The standard transfer replenishment alongside method (STREAM) is a high-speed, transfer method developed for transferring cargo and missiles between ships at sea. Passing a STREAM transfer rig is done in much the same manner as passing other rigs. During transfer, the missile is suspended from a combination strongback and trolley. The fundamental difference between STREAM and the conventional methods is the preset and controlled tension in the highline wire that allows STREAM to handle loads up to 9,000 pounds. A brief description of the major STREAM equipment follows.

Ram Tensioner

The ram-tensioned system employs an air-hydraulic ram unit to maintain constant tension on the span wire or highline, thus improving load control. An electronic control system assists the winch operator in maintaining desired tension on the ram-tensioned highline. The ram tensioner consists of a large hydraulic cylinder (the piston acts as the ram), an air compressor, an accumulator, and air flasks. The highline is reeved through a movable block on the piston and a fixed block on the cylinder and then passed to the highline winch. Air from nearby flasks keeps pressure on a piston in the accumulator cylinder, from which the pressure is transmitted to the ram. As tension on the highline or span wire is relaxed, pressure in the system causes the ram (piston) to extend, taking up the slack.

Sliding Block

The sliding block travels vertically on a king post of the delivery ship. The sliding block lifts the transfer load above bulwark obstructions before transfer. The highline is reeved through the sliding block.

Sliding Pad Eye

The sliding pad eye travels vertically on a king post or bulkhead on the receiving ship. Its function is to pick up and lower loads to the deck of the receiving ship. Other devices are available with STREAM that can perform a similar function.

Various items of specialized equipment have been designed for the STREAM system. These are used to handle missiles and other large or delicate ordnance.

STREAM equipment in this category includes missile strongbacks, dollies and adapters.

BURTON METHOD

Essential elements of the Burton rig are two winches and two whips, one each in each ship. The outer ends of the whips are shackled to a triple-swivel cargo hook, and the load is transferred by one ship paying out on its whip while the other ship heaves in on its whip. A single Burton can transfer loads up to 6,000 pounds.

There are various ways of rigging the delivering ship. Normally, the boom to the engaged side is used for the actual transfer and, with the boom on the opposite (or unengaged) side, for hoisting cargo from the hold. Another Burton method, may be used to transfer cargo when only one set of booms and winches is available at the active hatch.

Burton whips are of 6 x 37, high-grade plow-steel wire rope, 3/4 inch in diameter and 800 feet long. One is tended on the delivering ship and one on the receiving ship. Each ship furnishes its own whip.

SYNTHETIC HIGHLINES

Synthetic highlines are used to exchange personnel, light fleet freight, and mail during scheduled replenishments or as an independent operation.

WARNING

The maximum safe load for transfer by synthetic highline is 600 pounds.

EMERGENCY BREAKAWAY

During underway replenishment, an emergency situation may arise that requires an emergency breakaway. An emergency breakaway is an accelerated standard breakaway, using an orderly and prearranged procedure. The objective is to disengage quickly without damaging the rigs or endangering personnel.

Examples of conditions that warrant ordering an emergency breakaway are as follows:

- When either ship experiences an engineering casualty that affects its ability to maintain the replenishment course or speed
- When an enemy contact is reported that presents immediate danger

- When a carrier must break off for an emergency launch or recovery of aircraft

- When ships separate to the point where hoses appear in danger of parting; when separation distances cause wires to approach the last layer on the winch drums; or when a casualty or equipment failure may result in a tightline condition

- When a rig parts and there is a possibility that the screw will become fouled

- When a person is lost overboard and a lifeguard ship or helicopter is not on station

The order for an emergency breakaway may be given by the commanding officer of either the receiving ship or the delivery ship. Once initiated, the delivery ship will assume control and initiate proper hand signals with appropriate parallel information on the sound-powered phones to the receiving ship. Most important in the execution of an emergency breakaway is to allow sufficient time for the ships to disconnect the rigs in an orderly manner.

Sound-powered phones and hand signals should be the primary means of communication for ordering an emergency breakaway, because of the minimal amount of noise generated. However, 1MC, bull horns, and voice radio circuits should be used, if necessary, to ensure rapid ship-to-ship communications.

The danger signal (at least five short blasts) will be sounded by the ship initiating the emergency breakaway to alert all ships in the vicinity. In sounding five short blasts on the whistle to alert ships near emergency breakaway, due regard should be taken of (1) the tactical situation, (2) the effect on increased noise levels on conning officer-to-helmsman communication, and (3) the disruption to intership and intraship sound-powered phone communications caused by whistle signals. Radio, or even visual means, may be preferred to whistle signals to notify ships in company. Authorization and/or coordination for nonuse of whistle signals should be affirmed between ships involved in the underway replenishment and the officer in tactical command (OTC) before commencement of the underway replenishment.

The OTC and other ships in the formation should be informed immediately of the emergency via voice radio if security permits. Amplifying details must be relayed as soon as possible thereafter. When a condition warranting an emergency breakaway is recognized, the following actions should be taken:

1. Notify the following intraship stations of conditions or situations that require execution of an emergency breakaway:

- Bridge (initiate the danger signal by radio or visual means, if prearranged, or by sounding five short blasts on the ship's whistle)

- Cargo control center

- Fuel control center

- Fueling stations

- Cargo stations

2. Pass the word between ships according to prescribed procedures for the following:

- Bridge to bridge for all ships alongside

- Station to station

- Bridge to OTC and other ships in formation (security permitting)

3. Stop all transfers.

4. Retrieve rigs in accordance with prescribed procedures.

5. When all lines have been released by the receiving ship, both ships maneuver as appropriate to get clear.

VERTICAL REPLENISHMENT (VERTREP)

LEARNING OBJECTIVE: Define vertical replenishment (VERTREP). Identify the time when vertical replenishment is used,

Since vertical replenishment (VERTREP) is discussed extensively in Boatswain's Mate, Volume I, NAVEDTRA 10101, it will be discussed only briefly here.

Vertical replenishment (VERTREP) uses a helicopter to transport cargo from the deck of an underway replenishment ship to the deck of the receiving ship. VERTREP augments or, in some cases, replaces connected replenishment. It can be conducted with the receiving ship alongside during connected replenishment, over the horizon in an ASW screen, firing gunfire support, or at anchor anywhere within range. Range depends upon the helicopter, flying conditions, and the load.

Cargo can be carried internally, but the preferred method is to sling it externally since this method is faster and provides more flexibility. Internal cargo is restricted to cargo that can be handled by an internal winch with a capacity of 600 pounds. Depending on the helicopter and flying conditions, up to 7,000 pounds can be carried externally.

The majority of VERTREP cargo-handling items are identical to, or are adaptations of, ordinary cargo-handling equipment. For example, the forklift and pallet trucks, wooden and metal pallets, and nylon cargo nets used for VERTREP are the same as those used in ordinary cargo-handling operations. Other items that may not be so familiar are cargotainers, cargo wraparounds, special hoisting slings, and various missile containers and dollies.

The same procedures used during the day are used during nighttime VERTREPs, except that increased caution and precision are required. The primary difference between a day and night VERTREP is a reduction in the speed of operations, due to decreased visibility. Ships must be certified and authorized to take part in night VERTREP, and only those with proper lighting will be certified.

GENERAL REPLENISHMENT SAFETY PRECAUTIONS

LEARNING OBJECTIVE: Describe the safety precautions to be observed during underway replenishment (UNREP).

Persons assigned to replenishment stations must be thoroughly schooled in safety precautions and should be so well trained that they observe them almost automatically. Unfortunately, people tend to be careless, particularly when doing familiar tasks. A primary consideration in every shipboard evolution is the safety precautions required, depending upon the equipment used. Additionally, safety precautions must be reviewed immediately before each replenishment and must be observed. Following is a list of general safety precautions according to NWP 14.

- Only essential personnel should be allowed at a transfer station during replenishment.
- Lifelines should not be lowered unless absolutely necessary. If lowered, temporary lifelines must be rigged. Temporary lifelines should be a minimum of 2 inches (50.8 mm) in circumference.

- When the shot line is passed with a line-throwing gun the procedures set forth in NWP 14 are to be followed.
- Personnel assigned to each transfer station, including line and cargo handlers, should remove rings, watches, and other jewelry that could inadvertently be caught in the rigs, blocks, lines, or cargo.
- Personnel must be instructed to keep clear of bights, to handle lines from the inboard side, and to keep at least 6 feet (1.8 m) from the blocks through which the lines pass. If practical, personnel should be forward of the span wire or highline.
- Line-throwing gunners should wear red jerseys or red vests, and Signalmen should wear green jerseys or green vests. Jerseys should be worn under life jackets and vests should be worn over life jackets if personnel are in the water.
- Personnel should be cautioned to keep clear of a suspended load and to stay clear of the rig's attachment points until the load has been landed on deck. Personnel must remain alert and never turn their backs to any load.
- Be careful to prevent the shifting of cargo that might endanger personnel or material.
- Span wires, whips, and wire highlines should be secured to winch drums by one wire rope clip, or specially designed clamp, to lessen the possibility of damage should an emergency breakaway be necessary.
- Deck spaces near transfer stations must be covered with nonskid to provide secure footing.
- Both the delivering and receiving ships must station a lifebuoy watch well aft on each engaged side. The watch must have S/P phone communications with the bridge and must be equipped with two smoke floats and a 24-inch (60.9-cm) ring buoy fitted with a float light.
- All hands must be instructed on the hazards of emergency breakaway.
- Phone talkers on intership phone lines must not fasten their neck straps.
- Cargo handlers should not step on or in a cargo net attached to a cargo hook.
- Personnel involved in VERTREP must wear protective clothing and safety devices as indicated in NWP 14 and NWP 42.

- Easing-out lines, when appropriate, must be rigged immediately upon rig hookup to prepare for a possible emergency breakaway.

- Personnel in the immediate area of the transfer station must wear construction-type safety helmets, equipped with quick-acting breakaway devices. Chin straps must be fastened and worn under the chin. Safety helmets will be color-coded as follows:

WHITE— Officers, CPOs, and supervisors

WHITE (with green cross)— Safety Officer

YELLOW— Rig captain

GREEN— Signalmen and phone talkers

BROWN— Winch operators

PURPLE— Repair personnel

RED— Line-throwing gunners (or bolo heavers)

WHITE (with red cross)— Corpsmen

BLUE— Deck riggers and line handlers

ORANGE— Checkers and supply personnel

GREY— All others

- Except forklift truck operators, topside personnel who are engaged in handling stores or lines or who are in the transfer area must wear properly secured, orange-colored, inherently buoyant, vest-type life jackets with collars. Forklift truck operators will wear inflatable life jackets fully ready for use: life jacket in front, opened, with the yoke over the head (except actual inflation).

- Personnel rigging aloft or working outboard of bulwarks or safety chains must wear a properly secured, orange-colored, inherently buoyant, vest-type life jacket with a buttonhole in the back cover to permit concurrent use of the safety harness and safety and working line. (See *Naval Ships' Technical Manual*, chapter 077, for details for use with a safety harness.)

- Personnel at a transfer station must wear a one-cell flashlight (or green chemical light), whistle, and sea marker (fluorescent) on the outside of their life jacket during night replenishment. Flashlights need not be lighted except at the discretion of the commanding officer. Chemical lights must be lighted, and are not to be discarded over the side during hours of darkness, during the replenishment, or until completely extinguished.

- Personnel involved in cargo-handling operations on both the delivering and receiving ships must wear safety shoes.

- Additional safety precautions to be observed during fueling can be found in NWP 14.

THE SEAMAN ALOFT

LEARNING OBJECTIVE: Describe the rigging used for going aloft.

As a Seaman in the deck division, you will be involved in painting or doing repairs while working either aloft or over the side. To do these tasks safely, you must be able to correctly rig and use both the boatswain's chair and the stage. You must also know the safety precautions involved in working aloft or over the side.

BOATSWAIN'S CHAIR

The boatswain's chair is a hardwood seat attached to a double bridle of stout line, as shown in figure 4-29. It is always bent to the gantline by a double becket. A length of slack end is left hanging, as shown, for use in securing to masts or stays aloft.

For a straight drop, as when painting down a mast, rig the chair for self-lowering. When you are coming down a mast, you will often find that the ladder takes you only to the crosstree. You must be hoisted from there to the truck by personnel on deck. When there is no way of getting to the truck by ladder, a dummy gantline usually is left reeved from the crosstree up through the sheave at the truck and back to the crosstree. The dummy gantline makes it unnecessary for anyone to climb the topmast to reeve a chair gantline through. You must never let the end get away from you and reeve out.

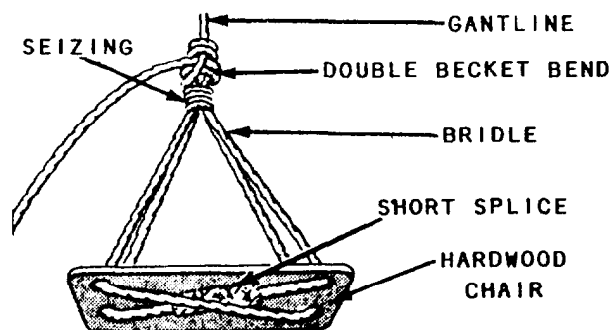

Figure 4-29.— The boatswain's chair.

A recommended method of securing gantlines is diagrammed in figure 4-30. The end of the chair gantline is secured to the end of the dummy gantline by butting the two ends together and seizing with turns of rope yarn back and forth between strands, so everything will pass through the sheave without fouling. The chair gantline is hauled up and through by the dummy gantline, the chair is heaved from the deck to the crosstree, and the hauling part is passed down to the party on deck.

Never attempt to hoist the chair aloft with the dummy gantline. All tools and equipment are attached to the chair so hands are free and to ensure the safety of anyone below from falling objects. When you are ready to go up, and the deck crew is ready to heave around, get in the chair and give a signal for them to pull you up. Help them by hauling down on the hauling part. Keep your hands clear of the part the chair is on or they may get jammed into the sheave when you are two-blocked to the truck. When the desired working height has been reached, signal the crew below and sing out “AVAST HEAVING”. The deck crew will stop pulling and hold the chair in place. Reach above the double becket bend and firmly squeeze the two parts of the gantline together. When you have a good grasp, command the deck crew “UP BEHIND.” This tells them to let go of the gantline. Warning: At this point, your grasp keeps the chair from falling. With your right hand, pull the gantline through the bridle and squeeze them together just above the double becket bend. Now the strain is on the bridle as in the first view of figure 4-31.

With your free left hand, pull up some slack from below so you have enough to pass over your head, clear around the chair, and under your feet, as in the second view of figure 4-31. The maneuver is a bit tricky, especially if you have a bucket or two hanging on the chair, but you will not have any trouble if you have enough slack pulled up. Keep hold of the gantline with your right hand until you have worked the hitch up to the apex of the bridle as shown in the third view of figure 4-31. Then hold the two parts of the gantline

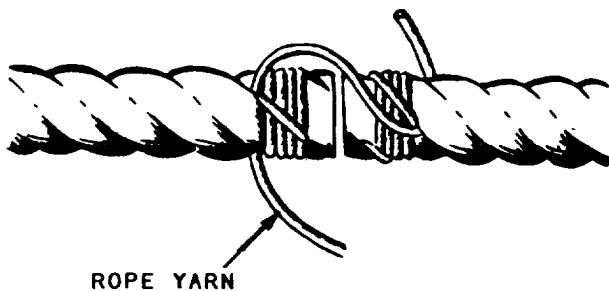

Figure 4-30.—Method of securing gantlines.

above your right hand with your left, and work the rest of the slack down.

You are now in no danger of falling, and all you have to do to lower the boatswain's chair is pull up slack and pass it around. Before you go aloft for the first time, though, you should practice hanging off deck a few times.

RIDING DOWN STANDING RIGGING

Standing rigging usually leads too far out from the mast for you to lower yourself when slushing down. Someone must lower you from on deck.

In riding down standing rigging, bend the tail of your gantline (fig. 4-31) to a shackle placed around the wire. Never place the shackle pin on the wire. It may unscrew as it travels along, and if it opens and lets go, you will swing back against the mast hard enough to injure yourself. Always put the bow of the shackle around the wire.

Personnel must adhere to the following safety precautions when working aloft:

- Obtain permission from the officer of the deck before going aloft.
- Make sure radio and radar units are OFF and that antennas are guarded. A “man aloft chit” is processed to ensure that key personnel are aware of any work being done aloft. The chit is signed by the ship’s electrical maintenance officer (EMO), communications officer (COMMO), and command duty officer (CDO).
- Tools and equipment will be tied to the boatswain's chair to prevent objects from falling on personnel below.
- Wear a safety harness and secure it to a fixed object above you once you are aloft.

WORKING OVER THE SIDE

LEARNING OBJECTIVE: Explain the procedures for working over the side and taking soundings.

Personnel preparing to work over the side should notify the officer of the deck (OOD). Upon securing, personnel should again notify the OOD.

All personnel working over the side of the ship on stages, boatswain's chairs, and on work floats or boats along the side of the ship are required to wear life

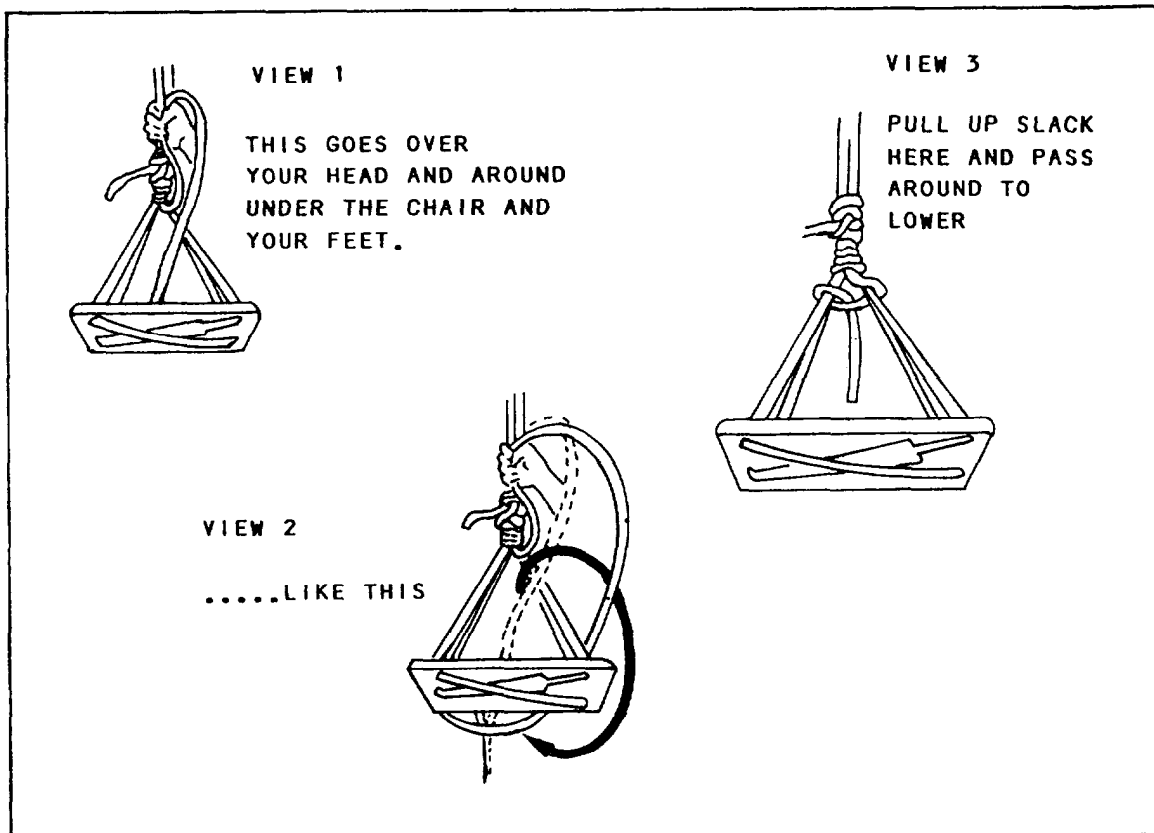

Figure 4-31.—Rigging for self-lowering.

jackets. Except for personnel in boats, personnel working over the side must be equipped with a parachute-type safety harness with safety lines tended from the deck above.

All personnel should be instructed in all applicable safety regulations before they are permitted to work over the side of the ship on scaffolding, stages, or in boatswain's chairs.

A competent petty officer must constantly supervise personnel working on scaffolding, stages, and in boatswain's chairs, and personnel must be assigned to tend the safety lines.

When personnel are doing hot-work such as welding or cutting while working over-the-side or aloft, fiber lines could burn and cause a serious mishap. To prevent this, replace all personnel safety lines and the fiber lines on the staging and boatswain chairs with wire rope. The Navy uses Corrosion Resistant Steel (CRES) wire rope. However, since the Navy supply system does not carry pre-assembled working or safety lines made of CRES, you must make them yourself.

When doing hot-work over the side, replace the nonadjustable, fiber-rope, working lanyard and the fiber-rope safety lanyard (DYNA-BRAKE, if needed) used with the safety harness with a 3/16-inch-diameter CRES wire rope. The wire rope should be 6-feet long (including the DYNA-BRAKE, if needed) with double-locking snap hooks at each end. Secure both hooks directly to the wire rope, using wire-rope thimbles and swaging.

All tools, buckets, paint pots, and brushes used by personnel working over the side of the ship should be secured by lanyards to prevent their loss overboard or injury to personnel below.

STAGE

The stage is a stout plank to the underside of which two short wooden horns are attached athwartships, either by nailing or bolting on, a foot or two from either end. When the stage is rigged properly, all the weight comes on the plank. The chief purpose of the horns is to hold the plank off the side.

The gantlines on your stage may be rigged in one of two ways. The first is by an eye splice in the end of the

gantline (fig. 4-32). Be sure to pass the part between the half hitches under the plank. If you pass it over, there will be nothing holding you up but the horns. The second method of rigging the stage is by the stage hitch shown in figure 4-33. This method is the better of the two because there are two parts of the gantline under the plank instead of one, and there is no need to eye splice the end.

REEVING GANTLINES

The best way to reeve your gantline for lowering is over a smooth surface. Never have your gantlines running over a sharp edge. Place chafing gear wherever the lines from your shackles cross anything sharp.

The following safety precautions should be observed while crew members are working over the side:

1. Lower one end of your partner's stage at a time while your partner keeps the other side secured.
2. Warn your partner before making moves that may jar the stage.
3. Always wear a safety harness and lifeline with dyna-brake when working on a stage.
4. Always wear a life jacket when working over water.
5. Keep clear of overboard discharges.
6. Do not secure safety lines or gantlines to the stations that hold up the lifelines; secure the line to a bitt or cleat.
7. Do not allow more than two persons on a stage at the same time.
8. Secure tools to the stage with small stuff to prevent them from dropping.

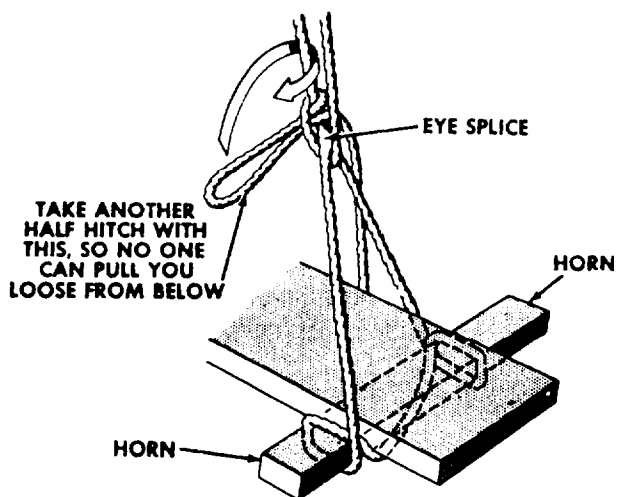

Figure 4-32.—Eye splice rig on a stage.

TAKING SOUNDINGS

Soundings (measuring the depth of water) are taken when the ship is going into or out of port or approaching an anchorage. The hand lead is the most accurate means for obtaining soundings. It is used in shallow water and when the speed of the ship is slow. Even though ships today have modern depth-sounding equipment, leadlines are a mandatory piece of equipment and are routinely inspected during inspections and refresher training periods.

LEAD LINE

The leadline or hand lead consists of a narrow block of lead weighing from 7 to 14 pounds, which is attached to a marked line (fig. 4-34). With the ship making 12 knots, a good leadsman can get reliable soundings down to 7 fathoms. At slower speeds, of course, the lead has time to sink even deeper before the ship moves up to it. The leadline may also be used for determining the direction in which a ship, practically dead in the water, is moving. Direction of movement is found by placing the lead on the bottom, directly below the leadsman, and noting the direction of the motion of the ship as shown by the change of direction of the leadline from the up and down.

Before heaving, the leadsman takes station in the chains, which usually are platforms projecting over each side at the after end of the forecastle. The lead is then lowered over the side and is supported in the heaving hand by a wooden toggle, inserted in the lead line about 2 fathoms from the lead. The spare line is coiled in the other hand, free for running.

To make the heave, start by calling out "WATCH-ON-WATCH" then swing the lead in a fore-and-aft direction outboard of the chains to gain momentum. Then swing the lead in a complete circle. When the force is great enough, let go the lead as it swings forward at a point about level with the deck.

As the ship moves ahead, heave in the spare line rapidly. The marker should be read when the lead is on the bottom and the line hauled just taut, up and down. The ability to heave the lead can be acquired only by practice. It is necessary to practice with both hands because the right hand is used for heaving from the starboard chain; the left hand for heaving from the port chain.

A good heave has no value unless the depth can be read correctly and quickly. Learn the markings of the leadline identified in figure 4-34.

Leadlines often are marked at each half fathom over the range of depth used most and may even have foot markings around the more important depths. Some

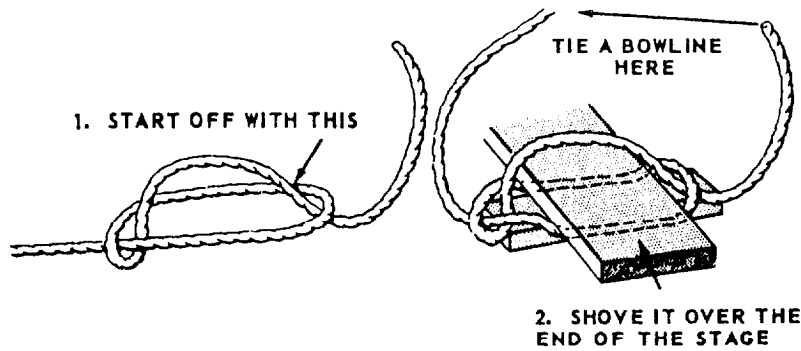

Figure 4-33.—Rigging with a stage hitch.

leadlines are so fixed that the depth may be read at the level of the chains instead of at the water's edge. This procedure makes it easier to take sounds at night. Learn

any special markings of the leadline that may be used on your ship.

Report each sounding to the bridge in a sharp, clear voice. When the sounding agrees with one of the marks, report it by mark as 2, 3, 5.

When it falls on an even fathom between marks, report it as by the deep 4, 5, 8 or 9. If the reading does not give an even fathom, it is reported, for example, as "A QUARTER LESS THREE", "AND A QUARTER, FOUR", "AND A HALF, FOUR." Respectively, these reports mean that there are 1/4 fathom less than 3 fathoms of water, 1/4 fathom more than 4, and 1/2 fathom more than 4. If the bottom is not reached, report "NO BOTTOM AT (number of fathoms)."

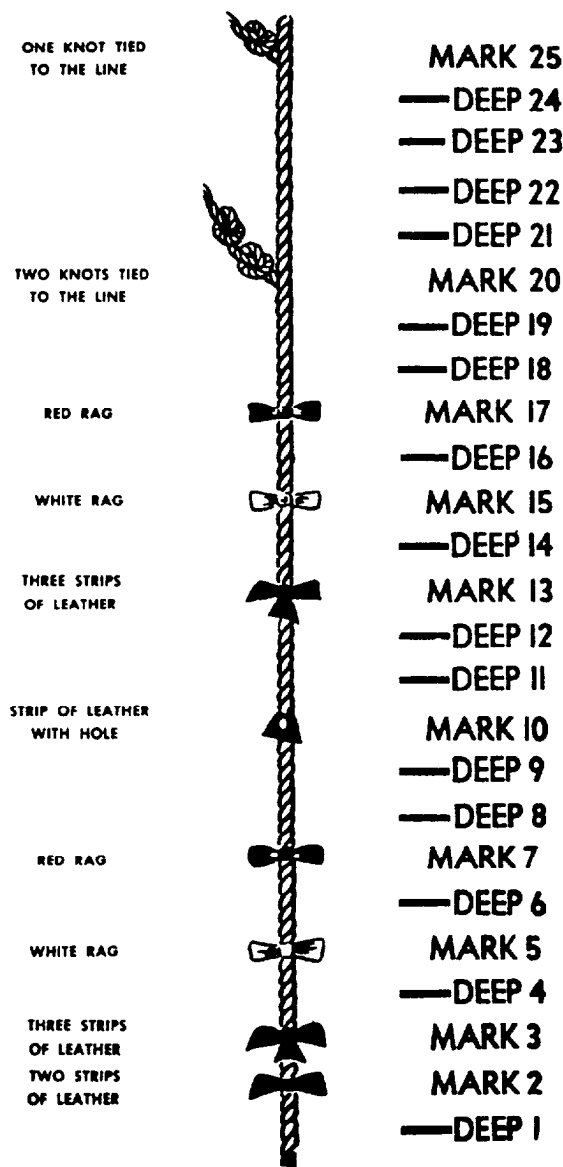

Figure 4-34.—Markings of lead line.

MOORING A SHIP WITH LINES

LEARNING OBJECTIVES: Describe the line-handling procedures to moor a ship. Recognize the difference between standing and running rigging.

The lines used to secure the ship to a wharf, pier, or another ship are called mooring lines. Five-inch synthetic rope is used for mooring lines in destroyers or smaller vessels. Larger ships may use 8-inch or even 10-inch lines. Nylon, polyester, and aramid fiber lines are now common for all types of ships. Aramid fiber rope is lighter and smaller (9 inch circumference nylon reduced to 5 7/8 circumference aramid) for equivalent breaking strength to other synthetic ropes. See figure 4-35. Each mooring line should be faked out on deck near the chock through which it will pass with each eye passed through the chock and looped back over the lifeline, for passing to the pier.

The mooring line that runs through the bullnose or chock near the stem of the ship is called the bow line. The line farthest aft at the stern line is called the stern line. These lines lead up and down the dock respectfully to reduce the fore-and-aft motion of the ship. Other

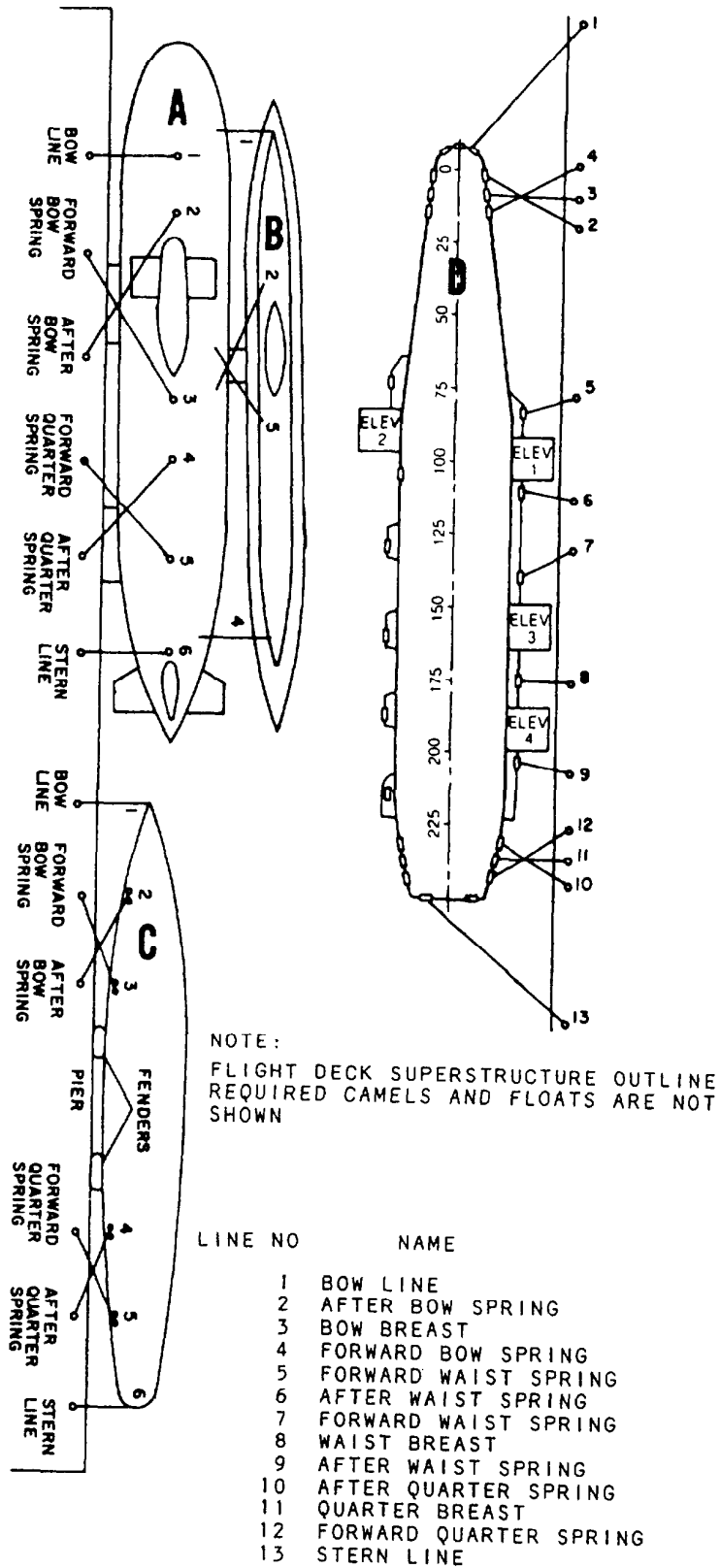

Figure 4-35.-Mooring lines.

Table 4-2.—Orders to Line Handlers

COMMAND	MEANING
PASS ONE (or NUMBER ONE)	Send line number one over to the pier. Place the eye over the bollard or cleat but do not take a strain,
SLACK (slack off) THE BOW LINE (NUMBER ONE)	Pay out the line specified, allowing it to form an easy bight
TAKE A STRAIN ON ONE (or NUMBER ONE)	Put number one line under tension
TAKE IN SLACK ON THREE (or NUMBER THREE)	Heave in on number three line but do not take a strain
EASE THREE	Pay out number three line enough to remove most of the tension
AVAST HEAVING	Stop heaving (taking in)
CHECK THREE	Hold number three line, and allow only enough of it to render around the bits to prevent the line from parting
HOLD TWO	Take enough turns so that number two line will not slip
DOUBLE UP AND SECURE	In addition to single part of a mooring line at each bitt, a bight of line is passed to the pier or other ship which gives three parts of line holding the ship
SINGLE UP	Take in all lines but a single standing part to each station (preparatory to getting underway)
STAND BY YOUR LINES	Man the lines, get ready to cast off or moor
TAKE IN ONE (or NUMBER ONE)	Retrieve line number one after it has been cast off. When used by the conning officer it means to slack one, cast it off, and then pull it aboard. When used by the officer in charge on the forecastle, it is preceded by the command slack one, cast one and cast off one and means merely to retrieve line one and bring it back on deck
CAST OFF	A command to those tending the mooring lines on the pier or on another ship to disengage or throw off the lines from over the bollards or cleats

mooring lines are called either breast lines or spring lines. They are called bow, waist, or quarter breasts and springs, depending on the part of the ship from which they are run.

Breast lines are run at right angles to the keel and prevent a ship from moving away from the pier.

Spring lines leading forward away from the ship at an angle are forward (bow, waist, or quarter) springs. Those leading aft are after (bow, waist, quarter) springs.

To prevent confusion and to increase the efficiency of line handling, lines are numbered from fore to aft, according to the position where they are secured aboard ship.

In securing alongside a dock, wharf, or pier, special attention must be paid to the tide conditions. When securing at low tide, leave ample slack in the lines to

ensure that, at high tide they will not part or cause the ship to list to a dangerous degree.

ORDERS TO PERSONNEL AT THE LINES

When you are handling mooring lines, it is important to observe all safety precautions and to make sure all personnel stay clear of bights of line. All lines are broken out and faked on deck in ample time before sea and anchor detail.

Depending on the class of ship, there is usually a first class petty officer or chief who is in charge of the fantail. The leading Boatswain's Mate and first lieutenant take charge of the forecastle.

Table 4-2 lists some of the orders to personnel assigned at the lines, with an explanation of each.

Be vigilant when you are handling lines by capstan. Warning of a dangerous strain is given by the creaking, stretch and reduction in circumference of the line when you are using nylon lines.

BLOCK AND TACKLE

A block consists of a wooden or metal frame (or shell) containing one or more rotating pulleys called sheaves. When a line or wire is reeved through a block or a pair of blocks, the whole arrangement becomes a tackle. Usually, the purpose of a tackle is to multiply the force applied on the hauling part of the fall. The number of times it is multiplied, disregarding friction, is the mechanical advantage of the tackle.

Every tackle contains a fixed block, attached to some solid support, and a movable block, attached to the load. The force applied at the hauling part is multiplied, excluding friction, as many times as there are parts of the fall at the movable block.

A block ordinarily is referred to by the number of sheaves it contains: for example, single sheave, double sheave, triple sheave. Its size is determined by the length of its frame (in inches). The frame is the main body of the block, and contains the metal strap supporting the pin on which rotates the sheave(s). Multiple-sheave blocks usually have both inner and outer straps. The closed upper end of the strap on a wooden block holds the hook or shackle; the other end accommodates the becket, for securing the end of the fall.

Wooden blocks are used exclusively with line; they are never used with wire. Blocks for wire normally are all-steel, heavy-duty, roller-bearing blocks, either self-lubricating or equipped with fittings for grease guns.

A snatch block is a single-sheave block, a part of which (strap) opens on a hinge so a line may be layed in the block. Fairleading, causing a line or wire to lead angularly around an obstruction and then straight to some desired point, is the usual purpose of a snatch block. See *Boatswain's Mate, Volume 1*, NAVEDTRA 10101, for further discussion on the blocks and tackle.

STANDING RIGGING

Standing rigging, usually of 6 by 19 galvanized high-grade plow-steel wire rope, is used to support the masts. The fore-and-aft supports are called stays, and the supports running athwartships are called shrouds. Stays and shrouds are set up at the lower end with turnbuckles, and those in the line of fire of the guns are also fitted with pelican hooks so they may be moved

quickly. Vibration often causes turnbuckles to back off. To prevent this, keepers are installed on turnbuckles in standing rigging.

All standing rigging is grounded to the ship's structure with a bonding strap to eliminate the effects of charges in rigging induced by electromagnetic radiation. When you make any adjustments to the shrouds and stays, the bonding straps must be disconnected to prevent damage and/or breaking. Upon completion of adjustments they must be reconnected.

If shrouds and stays are allowed to become slack, their effectiveness is reduced. Standing rigging should, therefore, be inspected periodically and tightened if necessary. The following procedure should be observed when considerable adjustments are required:

1. Disconnect bonding straps. Loosen turnbuckles to slack all shrouds and stays so no unbalanced forces are applied to the mast.

2. Take up the slack as uniformly as possible until sag is eliminated from all stays and shrouds, and turnbuckles are hand-tight. Measure the distance between the ends of the turnbuckle bolts.

3. Tighten each turnbuckle so it is shortened by a distance equal to 1 inch for each 60 feet of stay length. Reconnect the bonding straps.

Insulators should present clean surfaces. They should not be painted, tarred, varnished, or coated in any way.

All electrical bond straps on standing rigging should be inspected for damage, broken or missing fittings, and excessive deterioration at points of contact between dissimilar metals as specified by the PMS periodicity and procedures. Deficiencies should be reported to the work center supervisor and/or division officer.

DECK SAFETY

LEARNING OBJECTIVE: Explain the importance of deck safety.

Lines must never be made fast to capstans or gypsy heads, but only to fittings such as cleats or bitts provided for that purpose. When hawsepipe covers are removed for any purpose, a safety guard must be installed forward of each hawsepipe to prevent personnel handling lines from stepping or falling into the opening. When heaving around or veering the anchor cable, only authorized personnel may remain on the

forecastle. In letting go the anchor, the brake operator must wear goggles while handling the brake.

Ring buoys with a line and light attached must be available for use when a sea ladder or a Jacob's ladder is being used.

LIFELINES

Personnel are not permitted to sit or lean on the lifelines at any time. Lifelines are safety barriers to prevent personnel from falling or being washed over the side. When lifelines are removed for any purpose, the officers and petty officers concerned are required to ensure that emergency lines are rigged and that everyone has been cautioned to keep clear. While working over the side in port or at sea, personnel must wear life jackets, safety harnesses with safety, and tending lines attached, and a safety helmet.

When the ship is underway and a crew member has to work outside the lifelines, permission must be obtained from the commanding officer.

At sea, weather decks of ships can be extremely hazardous, particularly aboard small ships. At any moment, the sea can submerge the main deck to a depth of several feet or a wave may come unexpectedly over the bow or fantail.

If your duties do not require you on the main deck, do not go there. Be aware of any locations on deck that present any tripping hazards. Line handlers should stand at least 6 feet away from the block through which the line passes. Always stand clear of the bights of a wire rope or a line.

During heavy weather, don't go on deck unless the officer of the deck gives you permission. Then, work in pairs and wear inherently buoyant (kapok) life preservers, safety harnesses, and safety lines.

CRANES, CAPSTANS, WINCHES, AND WINDLASSES

Only trained personnel and those who have been authorized specifically by the first lieutenant are permitted to operate cranes, capstans, winches, and windlasses. Except in an emergency, operation of the machinery must be supervised by a responsible officer or petty officer. The method of operation and all necessary special instructions must be posted at the place of operation.

Experienced personnel must always supervise the topping and lowering of booms. Before making any repairs or replacing any of the gear, personnel should always lower the booms on deck. Chapter C6, Volume 2 of OPNAVINST 5100.19 (*NAVOSH Program Manual for Forces Afloat*) contains safety precautions on cranes, capstans, winches, and windlasses.

LUBRICATING WEATHER DECK EQUIPMENT

LEARNING OBJECTIVE: List and explain the importance of lubricating weather deck equipment.

All weather deck equipment must be lubricated properly to ensure protection against wear and weather elements. This section deals with the lubrication of the boat davits, standing rigging, running rigging, and the like.

WARNING

All greases, lubricants, and cleaning compounds are hazardous materials. Avoid prolonged skin contact and always wear goggles when using these materials. Use in a well-ventilated area.

BOAT DAVITS

Inspect boat davits as required by the Planned Maintenance System (PMS) schedule. Follow the regular lubrication of the mechanical parts as outlined in the individual manufacturer's manual and PMS. Coat the davit wire rope falls, gripes, and latch-releasing devices with grease. Be sure to apply grease thoroughly to the areas where saltwater would form a pocket. Examples of these areas are next to shackles buttons or cramps, and around the thimble.

STANDING RIGGING

All exposed wire, whether galvanized or not, must be covered with some surface coating for protection against the weather. For wire in standing rigging not subject to wear, weather protection is the only important consideration. The Maintenance Requirement Card (MRC) lists the preservatives needed. You can get them by submitting a supply requisition to the supply department.

RUNNING RIGGING

Wire rope for running rigging, as on cargo winches, must be covered with a mixture that provides lubrication as well as protection against the weather. A preparation of graphite and grease makes an excellent covering for running wire if no prepared mixture is on hand.

SHACKLES AND TURNBUCKLES

Particular attention must be paid to protecting the threads of shackles and turnbuckles. They are the parts that will be eaten away first if not cared for properly. Turnbuckles should be opened out frequently; the threads should be brushed well; and the movable parts should be lubricated with graphite grease.

WINCHES, CRANES, AND ANCHOR WINDLASSES

The maintenance and lubrication of heavy deck equipment, such as winches, cranes, and anchor windlasses, is performed by personnel of the A division of the engineering department. You should bear in mind, however, that the deck divisions work with this

equipment. For your own protection, therefore, you should assist a division as much as possible in the maintenance and lubrication of this equipment.

SUMMARY

In this chapter, we have discussed equipment and safety measures used on the deck of today's naval vessels.

More detailed discussion may be found in *Boatswain's Mate, Volume 1*, NAVEDTRA 10101, and other publications.

You must observe all safety precautions related to your work or duty assignments.

CHAPTER 5

BOAT SEAMANSHIP

The Navy uses thousands of boats, ranging in size from dinghies to landing craft. These boats are powered by diesels and by outboard motors. Most of them are built of steel, aluminum, or fiber glass. The term boat refers to small craft that are limited in use by their size. Usually, they are not capable of making regular, independent voyages of any length on the high seas.

This chapter is important because you, very early in your career, may be assigned as a member of a boat crew and later on as a coxswain.

To assume the duties of a coxswain, you must know the following:

- Who is responsible for each task
- What the duties of other crew members are, and be able to carry them out in an emergency
- The purpose of each piece of boat equipment
- How to read signal flags, so you can return to your ship if recalled

Small boats carried aboard a ship, which are lowered to perform various tasks, are known as the ship's boats.

The distinction between a ship and a boat is largely one of size; boats are carried by ships.

Boat seamanship encompasses more than a knowledge of the kinds of boats in operation in the Navy. Since boat crews are responsible for the upkeep and

maintenance of their craft, they must receive training in a number of other areas.

Some of the techniques to be mastered require considerable practice and experience before a boat crew member can become accomplished in this work.

Included in these skills are the following:

- Hoisting, lowering, and securing methods
- Operating boats properly under all conditions, including a knowledge of the Rules of the Road
- Knowledge of buoy systems
- Boat etiquette

NOMENCLATURE OF BOATS

LEARNING OBJECTIVES: Define boat nomenclature. List the parts of a boat and explain boat construction.

As used in this text, *nomenclature* refers to the names given to the various parts or fittings of a boat.

Most boats in service in today's Navy are of molded fiber glass or of metal skeletons to which metal plates have been attached to form a hull.

Figure 5-1 gives you an idea of how a boat is constructed. The backbone of the skeleton is called a keel, and its ribs are the frames. Bilges are the inner parts

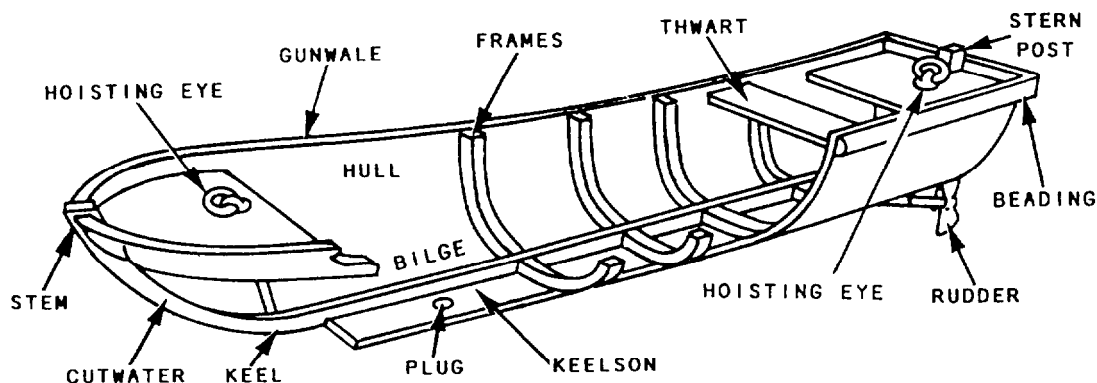

Figure 5-1.—Names of boat parts.

of the hull on either side of the keel up to where the sides begin.

The most forward part of the boat is the stem. The outboard part of the stem that is below the surface is called the cutwater. Starting just abaft the stem and running fore and aft on both sides, there is usually a half-rounded fender, called the beading. Aft the stem is a ring (hoisting eye) and cleats, used for securing the boat's painter (which is the line used to make the boat fast by the bow. A similar line in the stern is called a stern fast.) At the after end is the sternpost.

Somewhere in the bilges forward and aft, adjacent to the keelson (inside upper edge of the keel), every boat has a couple of screw plugs, which permit water to be drained out when the boat is out of the water. Each Navy boat has a set of strong hoisting eyes for attaching slings or boat falls when hoisting. (Large craft have several sets of hoisting padeyes and multiple slings or a rigid for single point pickups.)

All boats are equipped with a rudder for steering when underway. A rudder blade is attached to the rudder stock, which enters the hull through a stuffing box. The

rudder is turned by a steering wheel attached to a system of ropes, push-pull cables, or a mechanically or hydraulically operated arm attached to the rudder stock.

Most boats 50 feet long or under are made of plastic or fiber glass.

TYPES OF BOATS

LEARNING OBJECTIVE: Identify the different types of boats used in the U.S. Navy.

There are a number of types of boats used in the Navy today. We briefly describe a few of the boats most commonly seen, although you will surely see many others during your naval career.

LANDING CRAFT

Landing craft (called boats) are carried by various amphibious ships and are referred to by designation. They are designed to transport personnel and/or cargo from ship to shore. Figure 5-2, view A is a line drawing of an LCP(L); view B is a line drawing of an LCM.

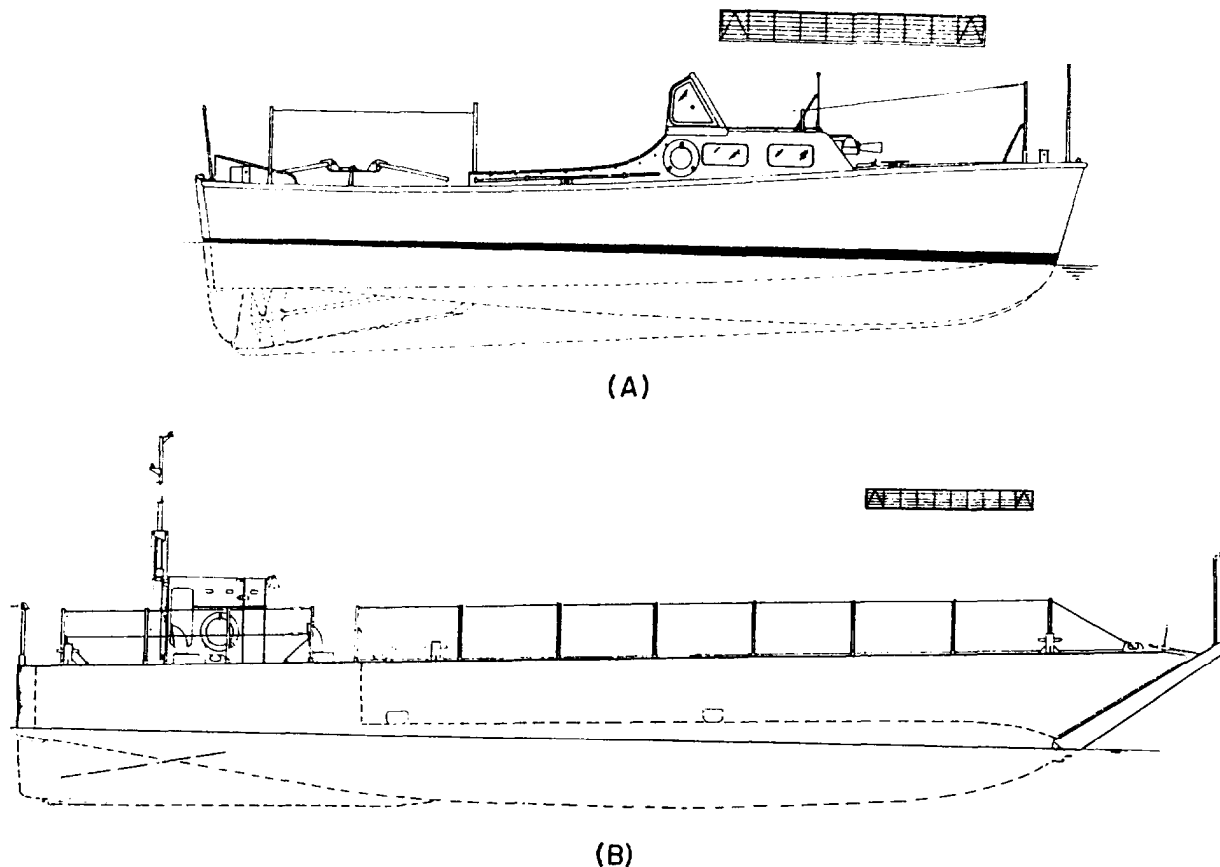

Figure 5-2.--Landing craft; (A) 36-foot LCP(L), (B) 74-foot LCM.

The following amphibious ships carries landing craft for the movement of personnel and cargo from the ship to shore.

- General-purpose assault ships (LHAs)
- Multipurpose assault ships (LHDs)
- Cargo ships (LKAs)
- Landing ships (LSDs)
- Tank landing ships (LSTs)

PERSONNEL BOATS

Personnel boats (fig. 5-3) are heavy-duty, square-sterned boats in various lengths from 26 to 40 feet. They are used to transport officer personnel from

ship to shore, act as the ship mail carrier, and to ferry cargo as needed. The larger personnel boats are divided into four spaces: the cockpit, the engine compartment, and the fore-and-aft passenger compartments. The smaller personnel boat has no fwd passenger compartment. A canopy may be installed over the cockpit during adverse weather conditions.

MOTOR WHALEBOATS (MWBs)

Motor whaleboats (MWBs) are round-bottomed, diesel-powered boats used as lifeboats and shipboard utility boats.

Some ships use MWBs as gigs and officers' boats, in which case they have canvas or herculite canopies. MWBs should never be overcrowded. The Mk 10 MWB

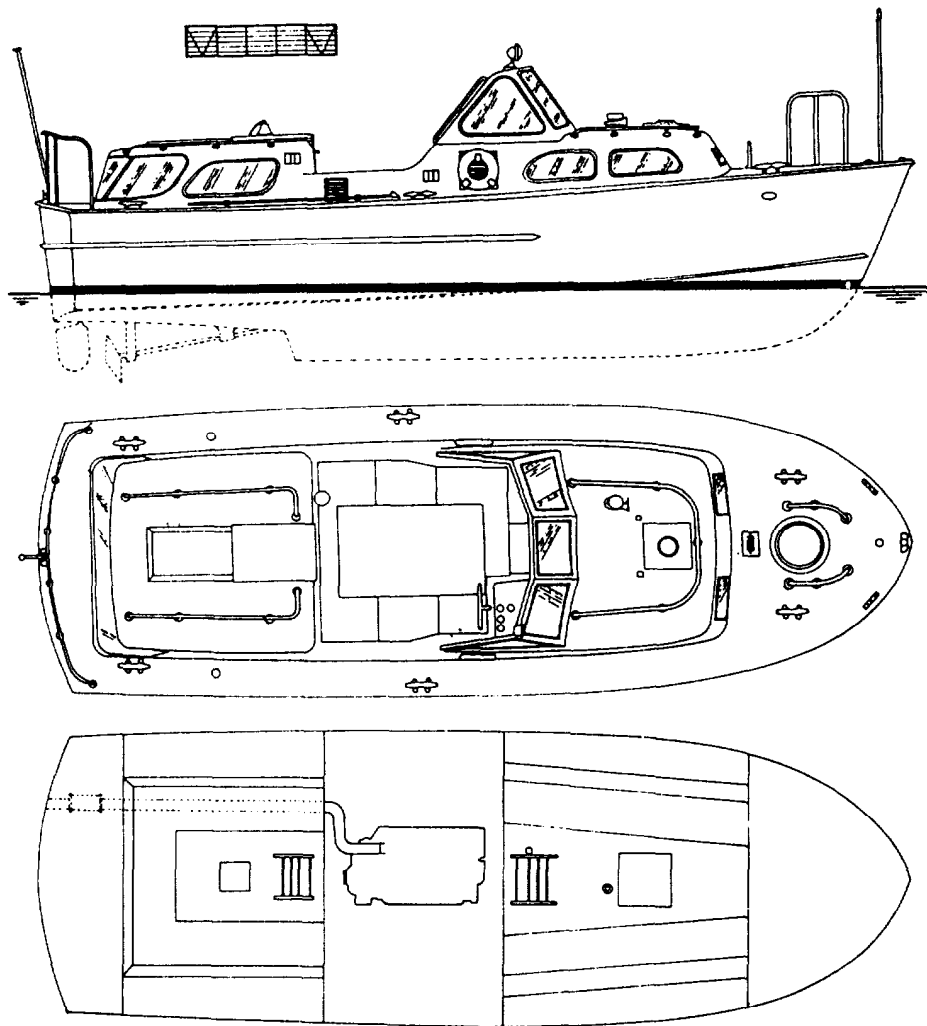

Figure 5-3.-33-foot personnel boat.

(fig. 5-4) is divided into the forward, engine, and after compartments.

UTILITY BOATS

Utility boats (UBs), 22 to 50 feet long, are generally used as cargo and personnel carriers (fig. 5-6) or as heavy-duty workboats. Many Ubs are modified for other operations.

PUNTS

Punts are open square-ended boats 10 or 14 feet long. They are rowed (sculled) and are generally used by side cleaners and paint crews. See figure 5-5.



3.234

Figure 5-4.—Mk 10 motor whaleboat.

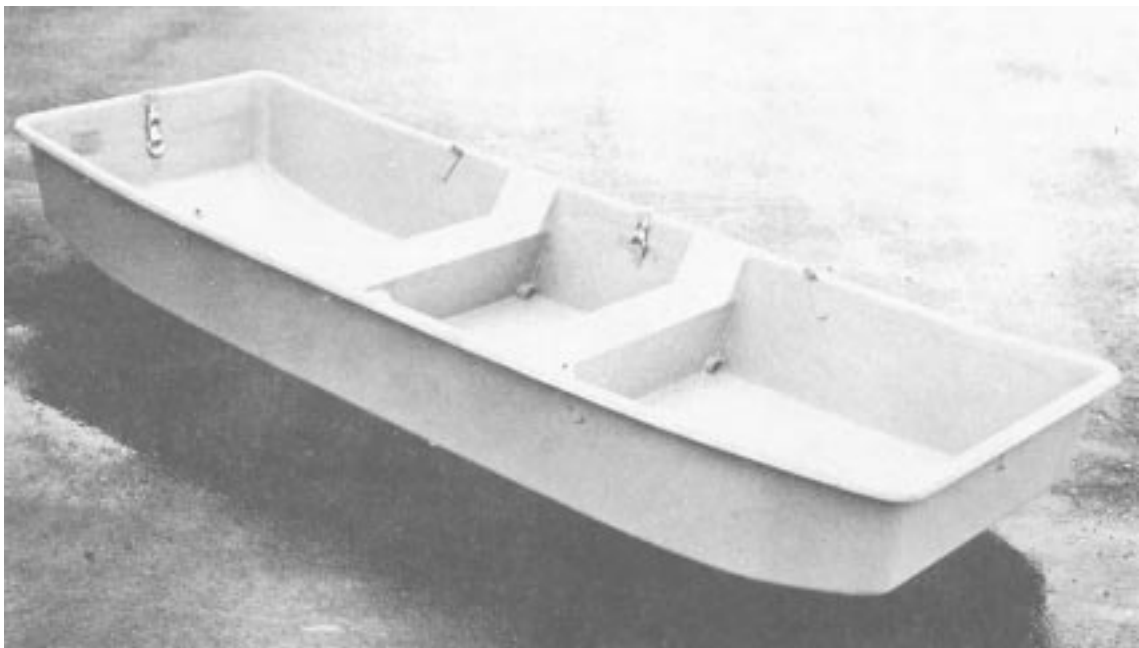

118.47

Figure 5-5.—14-foot punt.

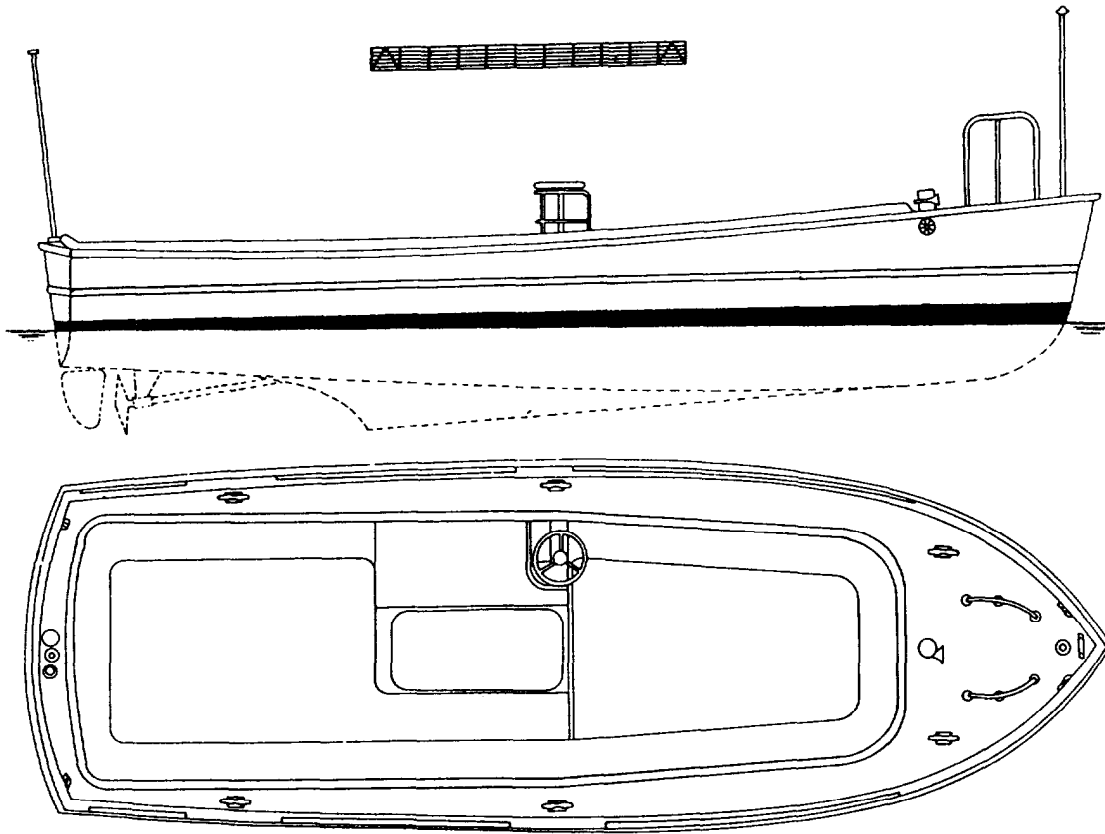

Figure 5-6.-33-foot utility boat.

STANDARD BOAT EQUIPMENT

LEARNING OBJECTIVES: List the standard boat equipment. Explain the upkeep, maintenance and care of small boat equipment.

Every Navy boat in active service is required to have a complete outfit of equipment as designated by the Naval Sea Systems Command (NAVSEASYSKOM), *Naval Ships' Technical Manual*, Chapter 583, "Boats and Small Craft", OPNAVINST 3120.32 B and applicable publications.

The Coordinated Shipboard Allowance List (COSAL) lists all the items required with the boat on the ship (items furnished with the boat) and the items that must be requisitioned. The equipment furnished with each boat, called portable parts, generally consists of the following items:

- Anchor, 30-pound LWT (lightweight)
- Bucket
- Life rings, 24-inch
- Fenders

- Grapnel, No. 4 with 6 feet of 1/4-inch close-link chain
- Boat hook, 8-foot
- Line, anchor, 25 fathoms of 2 1/4-inch line
- Line, grapnel, 15 fathoms of 21-thread line
- Bow, painter, 5 fathoms of 3-inch line
- Stern fast, 5 fathoms of 3-inch line
- Fire extinguisher, 15-pound CO2 portable type

UPKEEP AND MAINTENANCE

During active service, every effort should be made to provide thorough ventilation and drainage and to prevent water leakage. Standing water and oil in the bilges, even in small amounts, is hazardous; therefore, seams must be carefully caulked and maintained watertight. In fair weather, hatches and deck plates of boats afloat should be opened to increase air circulation. Wet dunnage, line, and life jackets in lockers should be removed and aired out. Boat crews should be alert for leaks beneath the covering board and deckhouse area.

CARE OF EQUIPMENT

When boats are removed from the water, propellers and sea suction should be checked and all deficiencies corrected. Engine oil should be changed after every 100 hours of running time, or as required by the Planned Maintenance System (PMS). Gear housings, steering mechanisms, and all moving parts must be kept well lubricated. Avoid spillage of fuel or oil; fumes from these are especially dangerous. The loads supported by gripe pads should be distributed as evenly as possible, to prevent hull deformation/damage.

BOAT CREW DUTIES

LEARNING OBJECTIVE: List and explain the duties of the boat crew.

All members of a boat crew must know their duties and be qualified second-class swimmers to ensure safe handling of the boat. This section covers the duties of the coxswain, the bow hook, the stern hook, the boat keeper, the boat engineer and the boat officer. The duties of the boat engineer are outlined in the latest Fireman TRAMAN. The duties and responsibilities for boat operation are outlined in the Ship's Boat Bill. The coxswain must know the bill and its contents.

DUTIES OF THE COXSWAIN

As the coxswain of a boat, you must assume many duties and responsibilities. It is your duty to be familiar with all details relating to the care and handling of your boat. As a coxswain, you must know the boat's physical characteristics, draft, and cargo and passenger capabilities in both fair weather and foul. These capacities are stamped on the boat label. It is important that the limits not be exceeded. Subject to the orders of the officer of the deck (OOD) and the commanding officer, you, as the coxswain, will have full charge of the boat and its crew.

WARNING

Boat crews entering or leaving the boat via the boat boom must wear inherently buoyant (kapok) life jackets.

The coxswain is responsible for making sure the boat crew and personnel embarked comply with all safety regulations. (Passengers, regardless of rating, must obey the coxswain's orders if they concern the

operation of the boat or the safety of personnel aboard) All boat passengers and crew must wear life jackets when weather conditions are hazardous.

Before operating the boat, the coxswain must inventory the personnel safety equipment and other equipment in the boat equipment to make sure it is all on board.

The coxswain must record courses and en route times, in the appropriate log, to all landings visited under various conditions of tide. The compass course and navigation aids, upon entry to a port, are verified in company with the navigator and/or quartermaster during the first boat run.

The coxswain is responsible to the OOD and the division officer for the boat's cleanliness and readiness for service. Coxswains and boat crews are representatives of the ship and should take pride in their appearance and in the image presented by their boat. The ship's regulations frequently require, for example, that crew members wear clean white sneakers. This is primarily a safety factor, but also aids in keeping boats looking neat.

Supplying oilskins or rain clothes for the boat's crew is the coxswain's responsibility. The gear should be all of one type, if possible, and should be kept in the boat when not in use. Wearing foul weather gear is strictly prohibited for boat crews unless severe weather requires its use. Usually, the senior officer present afloat (SOPA) issues instructions that set the uniform for boat crews. If you are not familiar with these instructions, check with the OOD before reporting for boat duty. Then inform your crew of the proper uniform so that all crew members will be dressed correctly before being called away.

When called away, man your boat promptly. In the absence of a boat officer, the coxswain receives orders from the OOD.

When the boat is underway, the coxswain should station the bow hook in the forward part of the boat to act as a bow lookout. This requirement is of major importance in boats such as LCMs, where the coxswain's vision is severely limited.

A boat coxswain must see that the crew and passengers sit in their proper places and that the crew outside the canopy conduct themselves in a military manner when salutes are exchanged.

Coxswains of powerboats should pay particular attention to canopy curtains. When curtains are not required, they should be rolled and stopped up. When in

use, they should be stopped down to the washboard. It is not "shipshape" to stop down only one corner of a side curtain. When running bow into the sea, it is sufficient to haul down the curtains on the weather side, leaving them furled on the lee side. Under all circumstances, the curtains must be stowed neatly in place. For safety, a ready exit from the boat is essential, and curtain stops should be broken easily from inside.

Coxswains of powerboats must require the stern hook to pay particular attention to the appearance of the boat's stern sheets. Cushion covers must be kept neat and clean. The boat flag, when not in use, should be rolled neatly on its flagstaff and triced up overhead. When a boat is called for the use of commissioned officers, the stern hook should spread the boat cloth neatly in the stern sheets of the boat. The stern hook must see that the foot cloths (or ladder if used) are on the proper side of the boat; that is, the side on which the passengers are expected to enter.

Officers of the deck (OOD) are responsible for the appearance of the ship; and, because they cannot see the ship as it appears from a distance, most will appreciate it if the coxswain quietly informs them of any irregularities noticed about the ship. Some examples are items hanging over the sides, loose gun and gun director covers, and Irish pennants. The coxswain should make it a habit to notice such things when returning to the ship. After the coxswain returns from a run and reports to the OOD, the coxswain, when ordered, properly secures the boat to the boat boom, comes aboard, and waits for the next run (see fig. 5-7).

The crew must never be allowed to be absent from the boat without proper authority while it is at a landing.

The coxswain never permits smoking in boats. When boats are ordered to secure, they are reported as secured to the OOD by the coxswain. The coxswain must know the capacity of the boat in good and bad

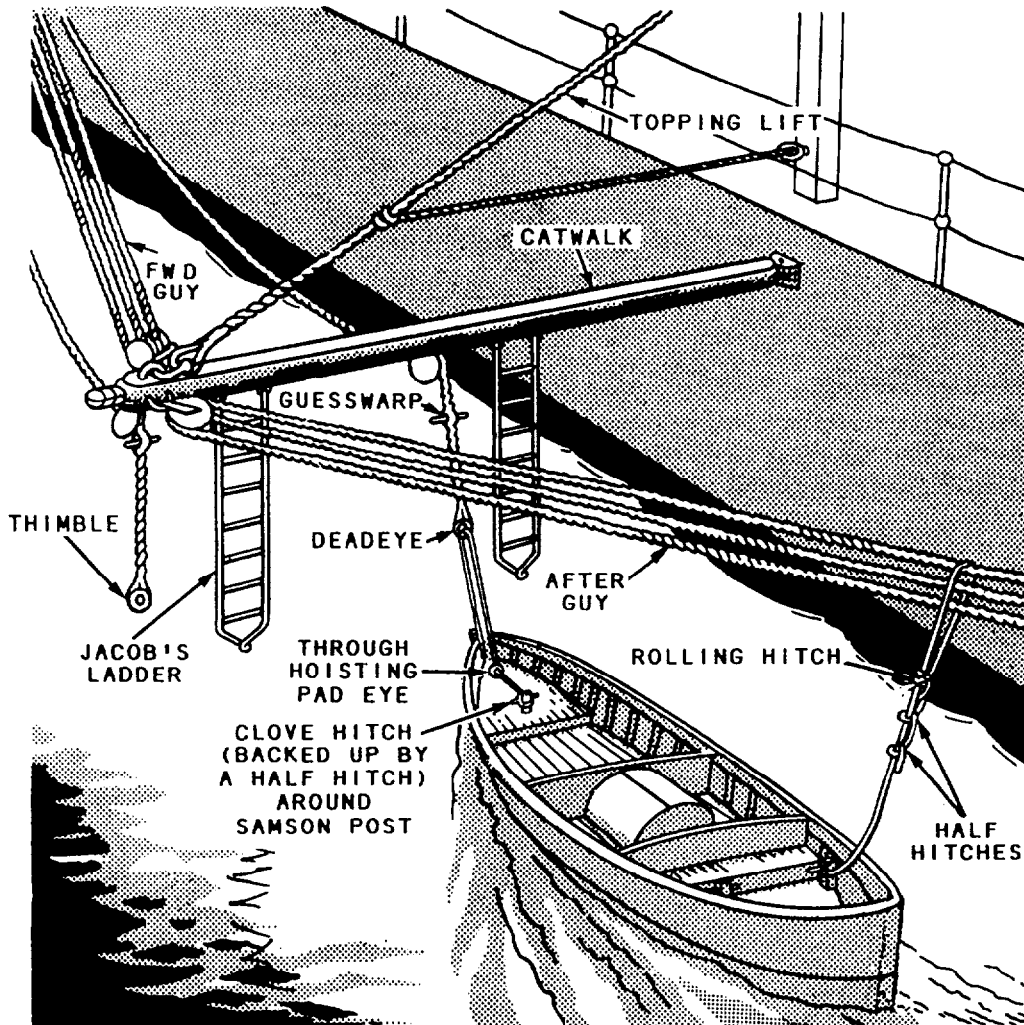

Figure 5-7.—Securing a boat to a boom.

weather conditions, as the boat will not safely carry the same number of people in bad weather as it will carry in good weather.

BOW HOOKS AND STERN HOOKS

Bow hooks and stern hooks must acquire all the knowledge necessary to operate the boat in the event that one of them should be required to relieve the coxswain in an emergency. When the boat is in operation, the bow hook should always be forward acting as a lookout, keeping watch for any floating object or hazard that might damage the boat or result in a collision. Both bow hooks and stern hooks should be ready at all times to fend off the boat from contact with other boats, the gangway, or the landing.

Bow Hook

On approaching the landing, the bow hook should be ready to spring ashore smartly with the bow line and take a turn on the nearest cleat. Also, the bow hook should be ready in the bow with the boat hook when approaching a ship's gangway, to snag the boat line and make fast. The bow hook should always have a fender ready to drop over at the proper spot if a bump becomes unavoidable.

Stern Hook

The stern hook, likewise, should be ready to jump ashore at once to make the stern fast. Both the bow hook and stern hook must be at their lines, ready to cast off and jump aboard, when the boat is about to get underway. They should never cast off, however, without orders from the coxswain. The coxswain frequently has to go ahead or back down on one of the lines to clear the landing. Lines should be kept neatly flemish down and the fenders rigged in when not in use.

BOAT KEEPER

Personnel assigned as boat keepers assume responsibility for care of the boat in the absence of the crew.

BOAT ENGINEER

The boat engineer performs maintenance on the engine as needed. Only the boat engineer should work on the engine. The boat engineer must ensure that the engine and the engine components are in good condition

and ready to run. The boat engineer also performs duty as a stern hook on most boats.

BOAT OFFICER

During heavy weather and other times as deemed necessary, an officer (sometimes a chief petty officer [CPO]) is assigned to a boat as the boat officer.

A boat officer naturally has authority over the coxswain. However, the boat officer does not assume the coxswain's responsibilities nor relieve the coxswain of his normal duties. The coxswain and the boat officer are jointly responsible for the boat and the safety and of the crew and the passengers. The situation is somewhat like the relationship between the OOD and the commanding officer on the bridge.

BOAT OPERATION

LEARNING OBJECTIVE: Describe the basic principles of boat operations.

One of the duties you may experience as a Seaman is as a member of a boat crew. You may be assigned as bow hook, stern hook, or perhaps even coxswain. You must know the nomenclature, characteristics, and handling of small boats.

HOISTING AND LOWERING

The process of hoisting and lowering boats with a crane primarily entails handling the slings by the safety runner (fig. 5-8). The safety runner, a short wire pendant, is attached to the bill of the hook on a boat crane and is connected to a tripping line. A pull on the tripping line causes the safety runner to dump the ring of the boat slings off the hook.

When a boat comes alongside a ship underway to be hoisted in, it first secures to the end of the sea painter—a strong line that hangs over the side of the ship and is located forward of the spot where the boat will be hoisted. The shipboard end of the line is bent securely to a cleat or a set of bitts. The eye of the sea painter is lowered to the boat and tended by means of a light line called a lizard line. The bow hook secures the eye to the inboard bow cleat, the cleat nearest the side of the ship.

NOTE

The sea painter is never secured to the boat's stern or to the side of the bow away from

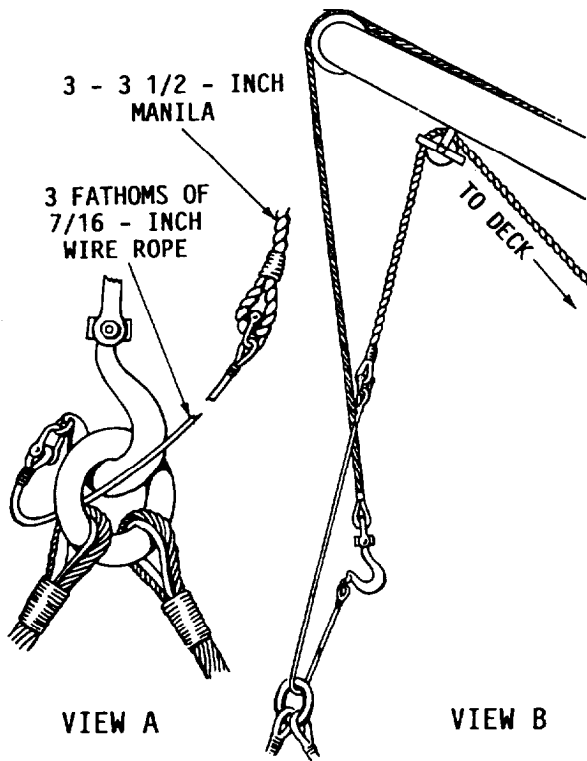

Figure 5-8.—Safety runner.

the ship. To do so would cause the boat to dive against the side of the ship when the boat begins to ride the painter, and it would probably capsize. It is important that the sea painter be adjusted properly and that the boat be allowed to drop back on it so that the boat's attachment point will be directly under the crane before lifting. Otherwise, it may broach to and capsize as it starts to leave the water.

Once it rides to the painter, and the slings are attached, the boat is lifted out of the water and the engine is secured. Steadying lines should be secured to the cleats on the outboard side of the boat and brought back on deck to hold the boat steady as it rises. The bow hooks and stern hooks must fend it off the side. When the boat is clear of the water, the engine is secured, and the plugs should be removed (so that the bilges will drain before the boat reaches the deck).

In operating with davits, the boat attaches to the sea painter and the steadying lines in the same manner, and must take the same precautions against broaching when lifted. The falls are lowered to the boat and the bow hook hooks the forward Raymond release hook

first (hook pointing aft). The bow hook must rotate the block until all the twists are out of the falls before hooking on; otherwise, a dangerous jam will occur as the blocks draw together. Once the forward block is hooked on, the stern hook removes the twists in the after fall and then attaches the after Raymond release hook (hook pointing forward). Both then secure the releasing hooks closed by their lanyards using three figure-eights and a half hitch. Manropes (monkey lines) are suspended from the strongback/span wire to the boat, and each person aboard must support part of his or her weight on the line as the boat rises, to be ready in any emergency.

Hard hats with chin straps and inherently buoyant life preservers must be worn by personnel when they are being hoisted or lowered in a boat.

ALONGSIDE SHIP OR LANDING

In operating a boat, the most important point to remember is that the stern, not the bow, goes off track first when the rudder is turned; the boat reacts to the rudder much faster at high speed than at low speed. Often, when you see that you did not allow yourself enough room for a turn, gunning of the engine will bring it around in time. You will have to make a judgment call on that.

All single-screw boats have right-handed screws turning in a clockwise direction going ahead, when viewed from astern. For this reason, the side force of the screw, when going ahead, tends to walk the stern to starboard when the boat is gathering headway. This screw action means that your boat always makes a faster turn to port than to starboard when gathering headway.

When backing, however, the stern tends to walk to port, no matter how much rudder you put on to the right. If you have to back a long stretch in a straight line, back with a hard right rudder until you start to curve to port. Then shift your rudder and gun your engine ahead fast. The boat straightens itself in a second, without losing sternway.

One of the first pointers you must learn about your boat is how fast it will backdown. It is next to impossible to back a boat in a straight line. You must use your rudder and, at times, shift your engine to back your boat because of the effect on the screw and rudder.

It is always easier to go alongside port-side-to than starboard-side-to. See figure 5-9. The reason: When you put your port bow alongside and start to back, the

side force of the backing screw on the stern will walk your stern alongside. If you have to go starboard-side-to, remember that you must come alongside much straighter, because the backing screw will walk your stern away from the landing. Make a starboard-side-to landing at slow speed, and work your engine and rudder to get the boat alongside.

When tying up to a ship's gangway in a tideway or stream, always secure the boat line to the ship side of the bow, and set the rudder a little away from the ship, so that the boat will ride clear. Tie up to a deck or landing, bow-on to the stream whenever possible, so you can set your rudder to hold it off in the same manner as just described. If the wind tends to throw the boat onto the landing, use less rudder and speed, and use your fenders to keep from chafing the boat against the pilings. Tie up with a bow line leading forward and stern line leading aft. Never have both lines leading in the same direction.

In getting underway from a starboard-side-to landing, usually it is best to back until the stern has walked itself away from the dock, because a single-screw boat will back to port. If you have no room astern, hold the bow by the bow line and go ahead slowly with a hard right rudder. When your stern is well out, cast off, back with a hard left rudder, and your stern will walk out without difficulty.

CAUTION

When you are shoving a boat away from the pier, the bow and the stern could fall in the water.

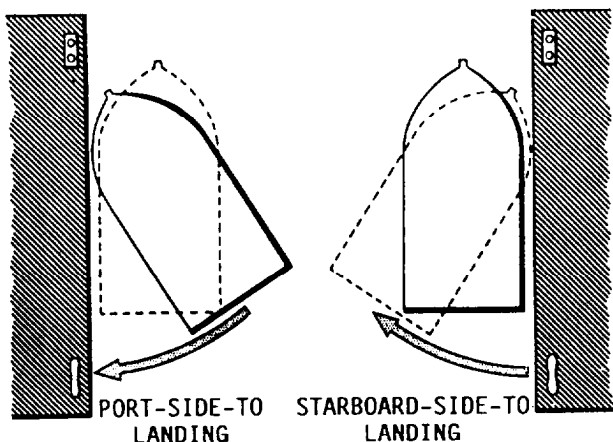

Figure 5-9.—Effect of backing propeller.

NORMAL AND HEAVY SEAS

With normal sea conditions, steering a powerboat is much the same as handling a single-screw ship, although the reactions of the boat to the engines and rudder are more pronounced. Too much weight forward may cause the bow of the boat to plunge into the waves.

Some hints on handling powerboats under special circumstances are given here as an aid to a boat crew that, having mastered the elements of its work, is ready to operate in more complicating situations.

When handling boats in a moderate or a rough sea, you must exercise caution, good judgment, and seamanship. Each member of the boat crew must know and perform all duties well to ensure the safe operation of the boat at all times.

One of the most risky situation arises when a powerboat is running before a sea. When the hull is lifted by the stern, there is danger that steerageway and power may be lost when the screw and rudder are clear of the water. The boat may then swing around broadside to the seas. The coxswain must rely on skill and training in the use of the rudder to keep the stern to the mountains of water. It is helpful to reduce speed and to allow large swells to roll by. In extreme cases, a drogue or sea anchor (fig. 5-10) may be used.

Running into a sea is less hazardous, but not without danger. Reduced speed lessens the strain on both engine and hull. To this end, the throttle should be adjusted so that the bow rises with oncoming waves instead of driving into them. Taking the seas on either port or starboard bow is sound seamanship, too, because some of the pitch is lessened by this method.

Avoid the trough, except in an emergency. When moving broadside to waves, turn the wheel momentarily, so as to take larger wave crests on the windward bow, and return to the course when conditions permit.

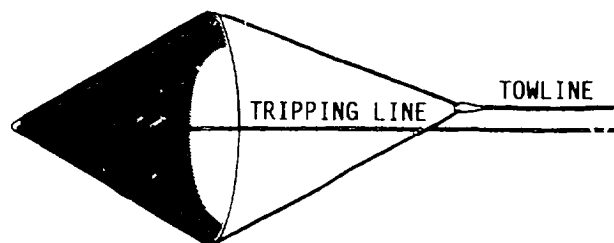

Figure 5-10.—Sea anchor or drogue.

The coxswain must keep the screw rotating sufficiently to maintain steerageway and then keep the bow facing the seas at an angle on either the port or starboard bow.

A drogue or sea anchor is a cone-shaped canvas bag about 2 feet wide at the mouth and approximately 4 1/2 feet long. It is towed open-end forward so as to offer resistance. The towline is made fast to the open end of a sea anchor, and a tripping line is secured to the pointed end. The drogue fills with water and tends to slow down the forward movement of a boat. The most important use of the drogue is in keeping a boat at right angles to a sea. The bow of a small boat can be kept toward the seas by rigging the drogue line and allowing the drogue's resistance to the water to hold the boat in position to the sea.

If the drogue is no longer needed, the towline is slacked and the tripping line is heaved on. This action causes the sea anchor to lose its resistance and enables the crew to haul it aboard.

SECURING FOR SEA AND READY LIFEBOAT

Boats are secured for sea when they are gripped down in the chocks, with plugs out and boat covers stoppered down securely.

The ready lifeboat, usually a motor whaleboat, is secured for sea in the davits, and, on some ships, swung out ready for lowering. As a safety measure, wire preventers connected to the davit heads may be attached to the boat's hoisting eyes, and the preventers must be cast off before lowering. They are equipped with pelican hooks, which can be tripped to transfer the boat's weight back to the falls.

The lifeboat has its sea painter and steadying lines already rigged, and the manropes from the span are coiled down clear for running. To keep it from swinging, the lifeboat is gripped against a pair of soft paddings on a heavy spar called a strongback, securely lashed between the davits. Canvas-covered lines running in a V-shape from the strongback around the boat to the deck are the gripes in this instance. They are brought down hard to the deck by means of a turnbuckle, with a pelican hook for quick releasing. The strongback is not always used. A set of inboard gripes, similar to those outboard, is used instead.

At the start of each watch, the Boatswain's Mate of the watch (BMOW) checks the ready lifeboat and reports the ready lifeboat condition to the OOD. It

should have a full tank of fuel and fuel oil reservoir. The bilge should be clean and dry with the boat plug in place. Life jackets and safety helmets should be ready nearby or in the boat so the crew may don them before lowering away.

BOAT ETIQUETTE

LEARNING OBJECTIVE: Explain proper etiquette procedures for a member of a small boat crew, including saluting, loading and off loading passengers.

Early in this chapter you were told that a ship is often judged by its boats and their crews. Clean boats and sharp crews draw favorable comments from superiors. An essential element for a smart crew is proper, seamanlike conduct. Following are a few rules of boat etiquette, established by custom and regulations, to serve as your guide to proper conduct when in boats. Observe them closely, and insist that others in your boat do likewise.

When there is no officer, petty officer, or acting petty officer in a boat lying at a landing, gangway, or boom, the personnel seated in the boat rise and salute all officers passing near. When an officer, a petty officer, or an acting petty officer is in charge, that person alone renders the salute.

Coxswains in charge of boats rise and salute when officers enter or leave their boats unless the safety of the boat would be imperiled.

When boats with embarked officers or officials in view pass each other, hand salutes are rendered by the coxswain and the senior officer embarked. The engine of the junior boat is idled during the salute. After the officer returns the salute, speed is resumed. Coxswains must rise while saluting unless it is dangerous or impractical to do so.

When a powerboat salutes another boat in passing, crew members outside the canopy stand at attention facing the other boat.

If a powerboat is carrying an officer or official for whom a gun salute is being fired, the engines are slowed and clutches are disengaged on the first gun, and the boat is headed parallel to the saluting ship. During the salute, only the person honored rises and salutes.

Enlisted personnel who are passengers in the stern sheets of a boat always rise and salute when a commissioned officer enters or leaves.

Boat keepers and all other personnel in boats not underway and not carrying an officer, a petty officer, or an acting petty officer in charge, stand and salute when an officer comes alongside, leaves the side, or passes near them. They should remain standing until the boat passes or reaches the ship's side.

Personnel working on the ship's side or aboard a boat do not salute unless ATTENTION is sounded.

Salutes aboard powerboats should be extended to foreign military and naval officers.

During morning or evening colors, powerboats should be stopped. The coxswain stands at attention and salutes. All others sit at attention.

No junior should overhaul and pass a senior without permission. The junior always salutes first, and the salute is returned by the senior. If doubt exists about the rank of an officer in a boat, it is better to salute than risk neglecting to salute one entitled to that courtesy.

Subject to the requirements of the rules for preventing collisions, junior boats must avoid crowding or embarrassing senior boats. At landings and gangways, juniors should give way to seniors. Juniors should show deference to their seniors at all times by refraining from crossing the bows of their boats or ignoring their presence.

Juniors precede seniors into a boat but leave after their seniors unless the senior officer in the boat gives orders to the contrary. As a general rule, seats farthest aft are reserved for senior officers. In personnel boats and motor whaleboats with no officers embarked, the stern sheets usually are reserved for chief petty officers.

Officers seated in boats do not rise in rendering salutes except when a senior enters or leaves the boat.

The position of attention in a boat is sitting erect.

Enlisted personnel who are passengers in running boats with officers maintain silence under ordinary circumstances.

Boats transporting seniors to a landing should be given first opportunity to land.

Except when excused by proper authority, boats should stand clear of shore landings and ship's gangways while waiting, and crews should not leave their boats. If a long wait is probable during bad weather or at night, permission may be requested to make fast to a boom and for the crew to come aboard.

When a visiting party is alongside, the petty officer in charge should go aboard and obtain permission before allowing any of the visiting party to leave the boat.

DISPLAYING NATIONAL ENSIGN, PERSONAL FLAGS AND PENNANTS

LEARNING OBJECTIVE: Describe the proper display of the national ensign, personal flags and pennants, bow insignia, and flagstaff ornaments on small boats.

This section discusses the proper display of the national ensign and personal flags and pennants from boats of naval vessels.

NATIONAL ENSIGN

The national ensign is displayed from naval vessels at the following times:

- When in port or at anchorage, the national ensign and the union jack are displayed from 0800 until sunset from the flagstaff and the jackstaff respectively. A ship that enters port at night, when appropriate, displays the national ensign from the gaff at daylight for a time sufficient to establish the ship's nationality; it is customary for other ships of war to display their national ensigns in return.

- During daylight, when underway in a foreign port.

- When required to be in full dress.

- When going alongside a foreign vessel.

- When an officer or official is embarked on an official occasion.

- When a flag or general officer, a unit commander, a commanding officer, or a chief of staff, in uniform, is embarked in a boat of his or her command or in one assigned to him or her for personal use.

- At such times as may be prescribed by the senior officer present afloat (SOPA).

PERSONAL FLAGS AND PENNANTS

Personal flags and pennants are displayed from naval vessels at the following times:

- An officer in command, or a chief of staff when acting for that officer, when embarked in a boat of the naval service on official occasions, displays from the

bow the command officer's personal flag or command pennant or, if not entitled to either, a commission pennant.

- An officer entitled to the display of a personal flag or command pennant may display a miniature of such flag or pennant in the vicinity of the coxswain's station when embarked on other than official occasions in a boat of the naval service.

BOW AND FLAGSTAFF INSIGNIA

A boat regularly assigned to an officer for personal use carries insignia on each bow as follows:

- For a flag or general officer, the stars as arranged in his or her flag
- For a unit commander not a flag officer, a replica of the command pennant
- For a commanding officer, or a chief of staff not a flag officer, an arrow

Staffs for the ensign, and for the personal flag or pennant in a boat assigned to the personal use of a flag or general officer, unit commander, chief of staff, or commanding officer, or in which a civil official is embarked are fitted at the peak with devices (shown in fig. 5-11) as follows:

- A spread eagle for an official or officer whose official salute is 19 or more guns. The head of the spread eagle must face forward.
- A halberd for a flag or general officer whose official salute is less than 19 guns or for a civil official whose official salute is 11 or more guns but less than 19 guns. The cutting edge of the halberd must face forward.
- A ball for an officer of the grade, or relative grade, of captain in the Navy or for a career minister, a counselor or first secretary of an embassy or legation, of a consul.
- A star for an officer of the grade, or relative grade, of commander in the Navy. The points of the star must face fore and aft.
- A flat truck for an officer below the grade, or relative grade, of commander in the Navy or for a civil official not listed above, and for whom honors are prescribed for an official visit.

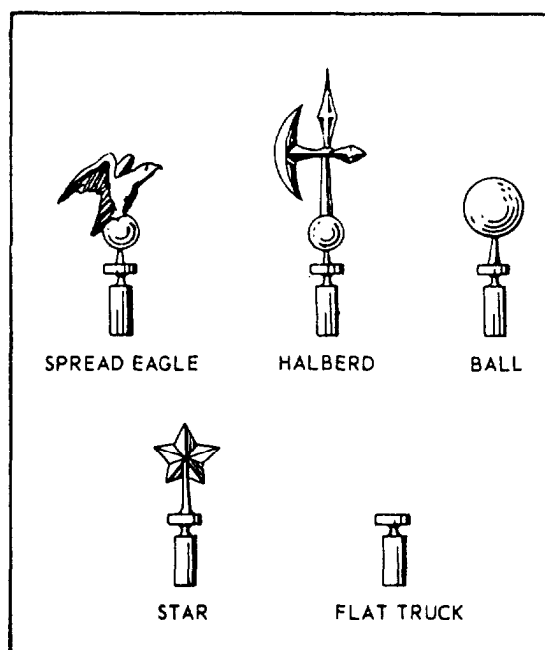

Figure 5-11.—Flagstaff insignia.

BOAT HAILS

LEARNING OBJECTIVES: Explain the procedures for challenging an approaching small boat. List and identify boat hails and their replies.

When a boat approaches a ship, the officer of the deck must know the rank of the senior officer embarked so that a proper reception with the appropriate ceremonies may be extended. During daylight hours, the officer of the deck (OOD) questions the boat coxswain to ascertain the rank of the senior officer by raising an arm straight up, fist clenched. The coxswain replies by showing fingers equal to the number of side boys the officer rates. Fleet admirals, admirals, and vice admirals rate eight side boys. Rear Admirals, upper and lower, rate six side boys. Captains and commanders rate four side boys, and all other commissioned officers rate two. Officers of other services rate the same number of side boys as their equivalents in rank. If there are no passengers in the boat who rate side boys, the coxswain gives the OOD a wave off.

At night the OOD hails a boat with “Boat ahoy,” and the coxswain answers, according to the senior embarked, as indicated in table 5-1.

BOAT CALLS

LEARNING OBJECTIVE: List and explain the recall signals for small boats including the Admiral's barge and the Captain's gig.

Occasionally it is necessary to recall personnel and boats by means of a flaghoist. The PAPA flag is the general recall when shown in port. It is flown from the foretruck, or where seen best, and means: All

PERSONNEL BELONGING TO THIS SHIP RETURN IMMEDIATELY.

QUEBEC, while flying, means: ALL BOATS BELONGING TO THIS SHIP (OR BOATS ADDRESSED) RETURN TO THE SHIP IMMEDIATELY.

If for any reason it is desired to call a particular boat, a hoist is flown as follows:

QUEBEC, followed by a numeral pennant, which designates a type of boat, and one or more additional numeral flags to indicate the number of the boat.

Table 5-1.–Coxswain Replies According to Senior Embarked

OFFICER OR OFFICIAL ABOARD SHIP	COXSWAIN'S REPLY
President or Vice President of the United States	UNITED STATES
Secretary, Deputy or an Assistant Secretary of Defense	DEFENSE
Secretary, Under Secretary, or an Assistant Secretary of the Navy	NAVY
Chairman, Joint Chiefs of Staff	JOINT CHIEFS
Chief of Naval Operations or the Vice Chief of Naval Operations	NAVAL OPERATIONS
Fleet, Force, or Type Commander	(<u>Number</u>) FLEET or abbreviation of administrative title; e.g., 6TH FLEET, PACFLT
A Flag Officer	FLAG OFFICER
A Chief of Staff/Chief staff Officer	STAFF
A Flotilla/Group Commander	(Type) FLOT/GRU (<u>Number</u>); e.g., CRUDESGRU SIX, SERVGRU THREE
A Squadron Commander	(Type) RON (<u>Number</u>); e.g., DESRON TWO
A Division Commander	(Type) DIV (<u>Number</u>); e.g., MINEDIV ELEVEN
A Marine Brigade Commander	BRIGADE COMMANDER
Commanding Officer of a ship or station	(Name of Ship or Station); e.g., NASHVILLE, NAVSTA NORFOLK
A Marine Regimental Commander	REGIMENTAL COMMANDER
Any other commissioned Officer	AYE, AYE
Warrant Officer	NO, NO
Enlisted	HELLO
A boat not intending to come alongside, regardless of rank of passenger	PASSING

The calls for the various types of boats follow:

BOAT CALL	BOAT TYPE
Qp0	All boats
Qp1	Admiral's barge
Qp2	Chief of Staff barge or gig
Qp3	Staff gigs or motorboat
Qp4	Captain's gig
Qp5	Boats under power
Qp6	Boats under sail
Qp7	Boats under oar
Qp8 to Qp50	Reserved for local assignment by commanding officer

Calls are usually assigned according to boat numbers.

An example of a call to own ship's boat is Qp52, meaning own ship's powerboat number 2.

To call another ship's boat, the ship's call is placed under the boat call. For example, Qp4Rp6p2 calls the captain's gig of carrier 62.

The general recall for all boats to return to their ships is QUEBEC hoisted singly.

Figure 5-12 illustrates the recall signal for the captain's gig (QUEBEC over PENNANT FOUR).

STEERING A BOAT BY COMPASS

LEARNING OBJECTIVES: Describe how to steer a boat by compass. Recognize compass error and describe how to correct compass error.

Standard powerboats and landing boats are always equipped with a compass. The coxswain uses this instrument more than any other device in piloting the craft to its destination.

Both the magnetic compass and the gyroscopic compass were explained in Chapter 2 of this book; hence, they are not discussed here. The rest of this chapter does, however, explain many of the things you must know about steering a boat by compass.

The coxswain must ensure that the compass light is installed and operating for night runs. To follow a compass course, the coxswain leaves the side of the ship, swings around to the bow, and uses either the point

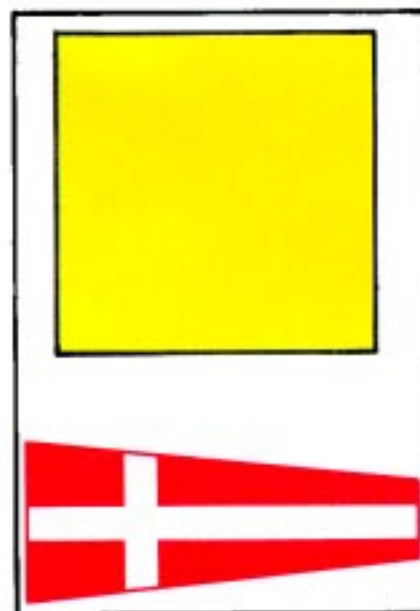

C118.49

Figure 5-12.—QUEBEC over Pennant Four.

where the anchor chain enters the water or, preferably, the anchor buoy as point of departure. The coxswain then steers the previously given compass course. By this method the boat should arrive at its destination with little difficulty if there is no wind or current, if the compass is in good condition, and if no metal objects (such as tools, or a large steel vessel passed en route) cause the compass to deviate.

It is necessary for the coxswain to move approximately 100 yards away from the ship before taking the compass reading. The reason is to prevent the magnetic attraction of the ship's hull from influencing the operation of the boat's compass.

Trust your compass. At times you may swear something has gone wrong with it, but that is probably your imagination, not a faulty compass. It is not a good practice to try to make your way from ship to ship by listening for the ship's bells.

Sound is deceptive in fog. Sound seem to come from everywhere at once. If you should become lost, you may have to listen for bells to try to find the nearest ship. Never leave your ship without knowing which berth the ship is in. Handle your compass with care so that you can rely on it when you need it.

COMPASS ERROR

Two forces make up compass error. They are *variation* and *deviation*. Earth is a huge magnet. The north magnetic pole of Earth is over a thousand miles

from the geographic North Pole. A magnetic compass points to magnetic north instead of true north because of Earth's magnetic field. The amount the compass is offset from the true pole is called variation.

Variation differs at various points on Earth's surface, and at many points it increases or decreases by a known annual rate.

Variation for any given locality, together with the amount of increase or decrease, is shown on the compass rose of the chart for that particular locality. On small-scale charts of larger areas, however, variation is shown by lines (isogonic lines) running through points with the same amount of variation.

Along each line or every fifth line (depending upon the type of chart used), variation is printed, and rates of annual changes are shown between the lines.

Figure 5-13 shows a compass rose indicating that in 1968 there was a $26^{\circ}45'$ easterly variation in that area and that it was increasing $11'$ annually. The total amount of variation is found by multiplying the number of years since the year printed in the compass rose by the rate of annual change. The result is either added to or subtracted from the variation given, depending upon whether the error is increasing or decreasing. In this instance, total variation in 1992 would be $24 \text{ years} \times 11' \text{ annual increase} + 26^{\circ}45' = 31^{\circ}09'$.

Variation remains the same for any heading of a ship or boat at any given locality. No matter which direction your boat is heading, the magnetic compass, if affected by variation alone, points in the direction of the magnetic pole.

Deviation is caused by the magnetic metallic masses in and on a ship. It is built into a ship and the

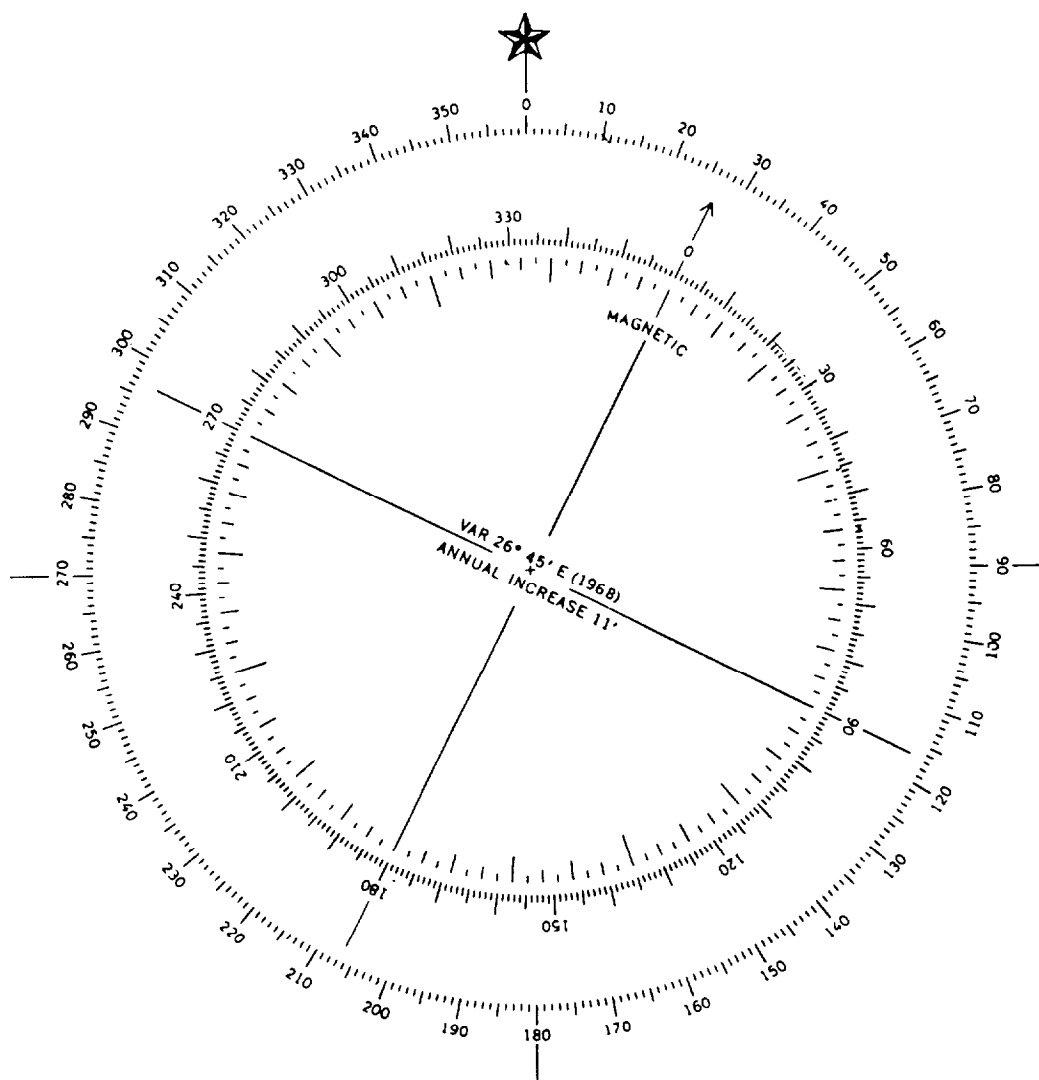

Figure 5-13.—Combination compass rose.

ship, in effect, becomes another magnet. We do not intend to give a detailed explanation of how this force affects a magnetic compass, but where deviation exists, it must be taken into account. Although it remains a constant amount for each compass heading, it gradually increases, decreases, increases, and decreases again as the ship swings through a complete 360° circle.

Deviation must be considered in correcting compass error, consequently the deviation for any given heading of a ship must be known. Before the ship puts to sea, it is swung through the complete circle from 0° to 360°, and the amount of the compass deviation is noted at every 15° swing. Compass deviation is calculated by various methods, generally by comparison with the gyrocompass, or by reciprocal bearings on a compass on the beach, which would be unaffected by the metal in the ship.

The results are compiled into a table called the deviation table (table 5-2). Every 15° is considered close enough, and in using the table, you should use the deviation for the heading nearest the heading you are checking. In other words, if you look in this table for the amount of deviation for a 17° heading, you would select the deviation for 15°, a deviation of 10°W.

When studying the compass, a coxswain should have the following definitions memorized.

Deviation— The error caused by the magnetic properties of any metal in the immediate vicinity of the compass. Deviation for a particular compass should be shown on the deviation table mounted near the instrument.

Variation— The angular difference between true north and the direction of Earth's magnetic field. Variation is marked on charts because it changes from year to year and from place to place.

Compass error— Deviation and variation together are known as the compass error.

True course— The angle between true north and the path along the ocean floor over which the boat is traveling, measured from true north in a clockwise direction.

Magnetic course—The angle, measured clockwise, from the magnetic meridian to the track. Correcting the magnetic course for variation gives the true course.

Compass course— The reading of a particular boat's compass when the boat is following a definite track. Correcting the compass course for deviation gives the magnetic course.

Correcting— The process by which both deviation and variation corrections are applied in converting a compass course to a true course.

CORRECTING COMPASS COURSE

The course you take from a chart usually is a true course. You must convert the true course from a magnetic compass to a compass course. To do this, you apply the compass error (variation and deviation) to the true course. Changing a true course to a compass course is called UNCORRECTING, and changing a magnetic course to a true course is CORRECTING. You can

Table 5-2.—Typical Deviation Table

DEVIATION TABLE					
SHIP'S HEADING MAGNETIC	DEV	SHIP'S HEADING MAGNETIC	DEV	SHIP'S HEADING MAGNETIC	DEV
000°	14°W	120°	15°E	240°	4°E
015°	10°W	135°	16°E	255°	1°W
030°	5°W	150°	12°E	270°	7°W
045°	1°E	165°	13°E	285°	12°W
060°	2°E	180°	14°E	300°	15°W
075°	5°E	195°	14°E	315°	19°W
090°	7°E	210°	12°E	330°	19°W
105°	9°E	225°	9°E	345°	17°W
				360°	14°W

remember this easily if you think of something that is TRUE as being CORRECT or already corrected. Another handy memory aid, CAN DEAD MEN VOTE TWICE, gives the key to the problem of changing from one to the other. Each word in our memory aid represents a word in our problem, as follows:

CAN COMPASS
 DEAD DEVIATION
 MEN MAGNETIC
 VOTE VARIATION
 TWICE TRUE

Variation and deviation are always given as EASTERLY or WESTERLY errors, and when CORRECTING (converting from compass to true), ADD easterly errors, and SUBTRACT westerly errors. When UNCORRECTING (converting from true to compass), SUBTRACT easterly errors, and ADD westerly errors.

Suppose the true course, taken from a chart, is 095°; variation, taken from the same chart, is 2° westerly; and deviation, taken from the deviation table, is 3° westerly. Now work the problem. Put down the things you know as follows:

C	D	M	V	T
	3°W		2°W°	095°

Do not forget the W (for westerly) or E (for easterly); otherwise you will not know whether to add or subtract the error. Now, true course was given, and we want to find compass course. We are uncorrecting; therefore, we add westerly errors and subtract easterly errors. Both errors are westerly, so we add them both.

C	D	M	V	T
100°	3°W	097°	2°W°	095°

Compass course is 100°.

Let us now set up a problem converting compass course to true course. We have given compass 193°, variation 7° easterly, and deviation 2° westerly.

This time we are correcting; therefore, we add easterly and subtract westerly errors.

C	D	M	V	T
193°	2°W	191°	7°E°	198°

After a little practice, you can work these problems in your head. Because it is compass course or true course you are interested in, find the algebraic sum of the two errors. An algebraic sum is obtained by adding the two errors if they are in the same direction, or subtracting the smaller error from the larger error if they are in opposite directions. The total error then is added to, or subtracted from, whichever course is given.

In many boats, deviation is very small or nonexistent; and when this is true, merely apply variation and you have your answer. In some boats, however, the motor and the other metal objects do cause deviation. These boats must be swung, deviation tables made out, and the date used when correcting the compasses.

RULES OF THE ROAD

LEARNING OBJECTIVES: List and explain the basic Rules of the Road. Identify and list sound signals.

International Rules of the Road are specific rules for all vessels while on the high seas and in connecting waters that are navigable by seagoing vessels. The Inland Rules apply to all vessels operating on the inland waters of the United States, and to vessels of the United States operating on the Canadian waters of the Great Lakes (to the extent that there is no conflict with Canadian law).

As a Seaman, you will need a basic knowledge of the Rules of the Road for boat operation.

The International Rules were formalized at the convention on the *International Regulations for Preventing Collisions at Sea*, 1972. These rules are commonly called 72 COLREGS.

The Inland Rules discussed in this chapter replace the old Inland Rules, Western River Rules, Great Lakes Rules, their respective pilot rules, and parts of the Motorboat Act of 1940. Many of the old navigation rules were enacted in the last century. Occasionally, provisions were added to cope with the increasing complexities of water transportation. Eventually, the navigation rules for the United States inland waterways became such a confusing patchwork of requirements that in the 1960s several unsuccessful attempts were

made to revise and simplify them. Following the signing of the 72 COLREGS, a new effort was made to unify and update the various Inland Rules. This effort was also aimed at making the Inland Rules as similar as possible to the 72 COLREGS. The *Navigation Rules, International-Inland*, COMDTINST M16672.2B now in effect, is the result.

Inland Rules vary from International Rules primarily because of the addition of certain extra precautions. In our discussion of basic rules, each rule stated is the same for both international and inland waters unless a distinction was pointed out. When the term *power-driven vessel* was mentioned, for example, it meant in both International and Inland, any vessel propelled by machinery as distinguished from a sailing vessel.

The basic rules concerning displays of navigational lights were given in chapter 2.

STEERING AND SAILING RULES

You must understand the steering and sailing rules and be able to apply them to various traffic situations. Although all Rules of the Road are important, the steering and sailing rules are the most essential to know to avoid collision. The risk of collision can be considered to exist if the bearing of an approaching vessel does not appreciably change.

NOTE

When you are approaching a very large vessel, or when you are in close quarters, a bearing change alone does not necessarily mean that a collision cannot happen.

We will illustrate the three situations in which the danger of collision might exist: head-on, crossing, and overtaking. The illustrations and the following summary will help you learn the rules and appropriate actions to be taken in each situation.

Meeting (Head-On) Situation

When two ships meet head on, or nearly so (fig. 5-14), each ship must change course to starboard and pass port to port. In international waters, a whistle signal is sounded only when a course change is actually made. If the meeting ships are already far enough off each other to pass clear on their present courses, no signal is sounded.

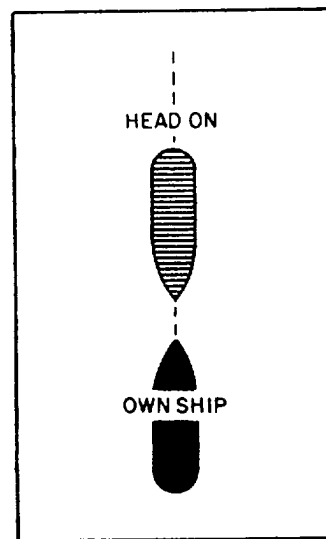
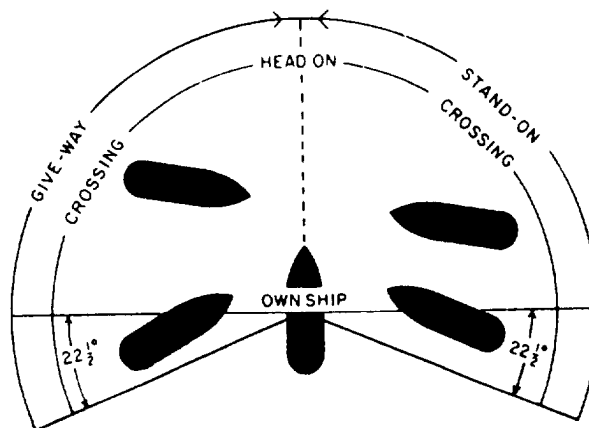

Figure 5-14.—Meeting (head-on) situation.

Crossing Situation

When two power-driven vessels are crossing so as to involve risk of collision (fig. 5-15), the vessel having the other to starboard is the give way vessel and must avoid the stand on vessel.

A sailing vessel has the right-of-way over power-driven vessels except when the sailing vessel is overtaking and the power-driven vessel is engaged in fishing, is not under command, or is restricted in its ability to maneuver.



NOTE:
VESSELS TO BE CONSIDERED IN
RELATION TO OWN SHIP ONLY.
COLLISION COURSE ASSUMED.

Figure 5-15.—Crossing situation.

Overtaking Situation

Any vessel overtaking another must keep clear of the overtaken vessel. An overtaking vessel is one that is approaching another vessel from any direction more than 22.5° abaft its beam (fig. 5-16). When in doubt, assume you are overtaking and act accordingly.

GENERAL DEFINITIONS

Before we continue with our discussion of basic rules of the road, you must first understand the terms we will use. They are as follows:

Vessel includes every description of watercraft, including nondisplacement craft and seaplanes used, or capable of being used, as a means of transportation on water.

Power-driven vessel means any vessel propelled by machinery.

Sailing vessel means any vessel under sail, provided that propelling machinery, if fitted, is not being used.

Give-way vessel refers to a power-driven vessel underway having another vessel to starboard, thus “giving-way” or allowing the other vessel to pass in an overtaking situation.

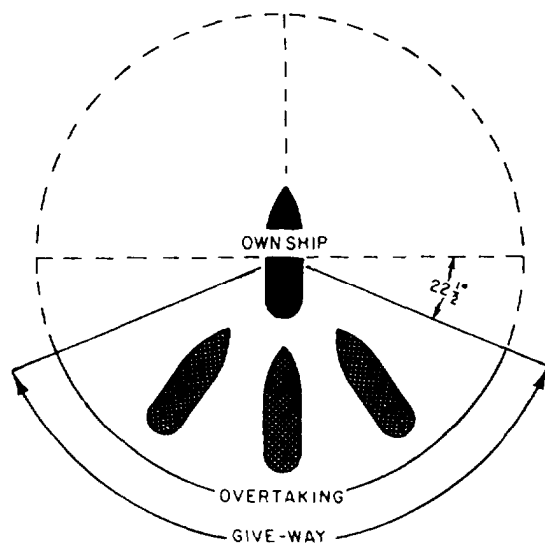

NOTE :
VESSELS TO BE CONSIDERED IN
RELATION TO OWN SHIP ONLY .
COLLISION COURSE ASSUMED

Figure 5-16.—Overtaking situation.

Stand-on vessel refers to any power-driven vessel in a crossing situation close enough to involve risk of collision; the vessel having the other to starboard must keep out of the way, or “stand-on,” not crossing ahead of the other vessel.

Vessel engaged in fishing means any vessel fishing with nets, lines, trawls, or other fishing apparatus that restricts maneuverability, but does not include a vessel fishing with trolling lines or other fishing apparatus that does not restrict maneuverability.

Seaplane includes any aircraft designed to maneuver on the water.

Vessel not under command means a vessel that, through some exceptional circumstance, is unable to maneuver as required by these rules and is, therefore, unable to keep out of the way of another vessel.

Vessel restricted in its ability to maneuver means a vessel that, from the nature of its work, is restricted in its ability to maneuver as required by these rules and is, therefore, unable to keep out of the way of another vessel.

Vessel constrained by its draft means a power-driven vessel that, because of its draft in relation to the available depth of water, is severely restricted in its ability to deviate from the course it is following (International Rules only).

Underway means that a vessel is not at anchor, made fast to the shore, or aground.

Length and *breadth* of a vessel mean its length overall, and greatest beam or width.

In sight means vessels are deemed to be in sight of one another only when one can be seen from the other.

Restricted visibility means any condition in which visibility is restricted by fog, mist, falling snow, heavy rainstorms, sandstorms, or any other similar causes.

Inland waters means the navigable waters of the United States shoreward of the navigational demarcation lines dividing the high seas from harbors, rivers, and other such bodies of waters of the United States, and the waters of the Great Lakes of the United States' side of the international boundary.

Demarcation lines means the lines delineating those waters upon which mariners must comply with the 72 COLREGS and those waters upon which mariners must comply with the Inland Navigation Rules. (The boundaries for the demarcation lines are listed in the back of the Coast Guard publication *Navigation Rules, International-Inland*.)

Whistle means any sound-signaling appliance that is capable of producing the prescribed blast and that complies with the specifications in Annex III of the International and Inland Rules. (When your ship was built and the whistle was installed, all the specifications listed in Annex III were considered.)

Short blast means a blast about 1-second long.

Prolonged blast means a blast from 4-seconds to 6-seconds duration.

Meeting (or head-on) situation defines a situation in which, by day, the masts of each vessel, when viewed from the other, are in a line.

Crossing situation defines the situation where each vessel has the other any place forward of 22.5° abaft of either beam.

Overtaking situation describes the situation where one vessel approaches the other from anyplace more than 22.5° abaft of either beam.

MANEUVERING AND WARNING SIGNALS

Since there are major differences between the International and the Inland maneuvering and warning signals, they will be presented separately, and the differences will be noted on the inland version.

International

When vessels are in sight of one another, a power-driven vessel underway, when maneuvering as authorized or required by these rules, must indicate that maneuver by the following signals on the whistle:

One short blast— I AM ALTERING MY COURSE TO STARBOARD

Two short blasts— I AM ALTERING MY COURSE TO PORT

Three short blasts— I AM OPERATING ASTERN PROPULSION

Any vessel may supplement the whistle signals prescribed above by light signals, repeated as appropriate while the maneuver is being carried out. These light signals will have the following significance:

One flash— I AM ALTERING MY COURSE TO STARBOARD

Two flashes— I AM ALTERING MY COURSE TO PORT

Three flashes— I AM OPERATING ASTERN PROPULSION

The duration of each flash will be about 1 second; the interval between flashes must be about 1 second; and the interval between successive signals must be not less than 10 seconds. The light used for this signal will be, if fitted, an all-around white light visible at a minimum range of 5 miles, and must comply with the provisions of Annex I that pertain to the International Rules.

When in sight of another in a narrow channel or fairway, and action is required by the vessel being overtaken, the vessel intending to overtake another must indicate its intention by the following signals on the whistle:

Two prolonged blasts followed by one short blast— I INTEND TO OVERTAKE YOU ON YOUR STARBOARD SIDE

Two prolonged blasts followed by two short blasts— I INTEND TO OVERTAKE YOU ON YOUR PORT SIDE

The vessel about to be overtaken will indicate agreement by the following signal on the whistle:

One prolonged, one short, one prolonged, and one short blast, in that order

When vessels in sight of one another are approaching each other and either vessel fails to understand the intentions or actions of the other, or is in doubt whether sufficient action is being taken by the other to avoid collision, the vessel in doubt must immediately indicate such doubt by giving at least five short, rapid blasts on the whistle. Such signal may be supplemented by a light signal of at least five short, rapid flashes.

A vessel nearing a bend or an area of a channel or fairway where other vessels may be obscured by an intervening obstruction must sound one prolonged blast. Such signal must be answered with a prolonged blast by any approaching vessel that may be within hearing around the bend or behind the intervening obstruction.

If whistles are fitted farther apart than 100 meters on a vessel, only one of the whistles will be used for giving maneuvering and warning signals.

These last three paragraphs apply to Inland Rules as well as International Rules.

Inland

When power-driven vessels are in sight of one another and meeting or crossing at a distance within half a mile of each other, each vessel underway, when maneuvering as authorized or required by the Inland Rules, must indicate that maneuver by the following signals on the whistle:

one short blast to mean I INTEND TO LEAVE YOU ON MY PORT SIDE

two short blasts to mean I INTEND TO LEAVE YOU ON MY STARBOARD SIDE

three short blasts to mean I AM OPERATING ASTERN PROPULSION.

NOTE

- The International Rules do not specify a distance for sounding signals.
- The International Rules read I AM, and the Inland Rules read I INTEND TO.

The one- and two-short-blast signals in the Inland Rules signify an intention of passage with one other vessel.

Upon hearing the one- or two-blast signal of the other, the vessel must, if in agreement, sound the same whistle signal and take the steps necessary to effect a safe passing. If, however, the vessel doubts the safety of the proposed maneuver, the vessel must sound the danger signal of at least five short, rapid blasts of the whistle. Each vessel will then take appropriate precautionary action until a safe passing agreement is made.

A vessel may supplement those signals with light signals.

Light signals must have the following significance:

one flash to mean I INTEND TO LEAVE YOU ON MY PORT SIDE

two flashes to mean I INTEND TO LEAVE YOU ON MY STARBOARD SIDE

three flashes to mean I AM OPERATING ASTERN PROPULSION.

The duration of each flash must be about 1 second, and the light used for this signal, if fitted, must be one all-around white or yellow light visible at a minimum range of 2 miles, synchronized with the whistle, and

must comply with the provisions of Annex I to the Inland Rules.

NOTE

- The Inland Rules do not specify an interval between flashes or an interval between successive signals.
- The International Rules do not allow a yellow light to be used for light signals.
- The minimum visible range for light is 2 miles for Inland Rules and 5 miles for International Rules.
- The Inland Rules require that light signals and sound signals be given at the same time (synchronized).

When in sight of another, a power-driven vessel intending to overtake another power-driven vessel must indicate its intention by the following signals on the whistle: one short blast to mean I INTEND TO OVERTAKE YOU ON YOUR STARBOARD SIDE; and two short blasts to mean I INTEND TO OVERTAKE YOU ON YOUR PORT SIDE.

NOTE

- The Inland Rules require signals for overtaking vessels when in sight of another in a narrow channel or fairway.
- The International Rules require two prolonged blasts preceding the short blast required by the Inland Rules.
- In both International and Inland Rules, overtaking signals are signals of intention only and must be answered by the vessel that is being overtaken.

The power-driven vessel about to be overtaken will, if in agreement, sound a similar sound signal. If in doubt, the vessel must sound the danger signal of at least five short, rapid blasts.

NOTE

The Inland Rules require the vessel being overtaken, if it agrees, to answer with a signal similar to the one sounded by the overtaking vessel. The International Rules require the vessel being overtaken, if it agrees, to sound one

prolonged, one short, one prolonged, and one short blast, in that order. The Inland Rules for overtaking vessels apply only to power-driven vessels; the International Rules apply to all vessels.

A vessel that reaches agreement with another vessel in a meeting, crossing, or overtaking situation by using the radiotelephone, as prescribed by the Bridge-to-Bridge Radiotelephone Act (85 Stat. 165; 33 U.S.C. 1207), is not obligated to sound the whistle signals prescribed by this rule, but may do so. If agreement is not reached, then whistle signals must be exchanged in a timely manner and will prevail.

RESTRICTED VISIBILITY

Conduct of Vessels in Restricted Visibility, Rule 20C, of both Inland and International Rules states that the lights prescribed by the rules are to be exhibited in restricted visibility. Rule 35 of both Inland and International Rules states that the required sound signals are to be sounded in or near an area of restricted visibility. Inland and International Rule 19 applies to vessels not in sight of one another when navigating in or near an area of restricted visibility.

Fog Signals

Before radar, the regulations depended almost solely on the fog signal; vessels in fog sounded fog signals and when other vessels heard them, they stopped. The increasing use of radar today has resulted in a supplementation to the existing regulations.

In 1960, a radar annex was appended to the International Rules; it was ultimately incorporated in 1972.

In 1980, the word *fog* was discarded and replaced by the term *restricted visibility*. The International Rules today make it clear that vessels must maintain a proper lookout.

The rules make it obvious that radar is NOT a substitute for a proper lookout. The courts have ruled that dependable radar equipment must be turned on and intelligent use made of it.

Rule 19E requires a vessel hearing a fog signal of another vessel to reduce its speed, to bare steerageway, and to proceed with caution.

No defined distance has been established regarding visibility for sounding fog signals. Three miles has been recommended for all vessels over 50 meters long. The

rules prescribe three types of devices: a whistle (for vessels underway), and a bell and a gong (for vessels anchored or aground). A whistle requires either a prolonged blast of 4-6 seconds or one short blast. A bell requires a 5-second rapid ringing. And a gong requires a 5-second rapid sounding. International Rules require a 2-minute interval between warning signals.

The fog signals for inland and international waters (COLREGs) are very similar but there are two exceptions. First, the Inland Rules do not provide for a vessel constrained by draft; and second, they do not require small vessels in specifically designated anchorages to sound fog signals.

Small boats, as well as larger vessels, are required to signal. A boat coxswain must have a foghorn in the boat at all times. Motorboats must be outfitted with an efficient whistle, horn, or other sound-producing device.

It should be noted that because a boat is exempt from some specific requirement of the rules, it is not excused from complying with the rules in all other respects.

Sound Signals

The sound signals in restricted visibility for the International and Inland Rules are very similar. In this part of the text, only the Inland Rules will be presented. Any differences between the International and Inland Rules will be noted.

In or near an area of restricted visibility, whether by day or night, the signals prescribed in this rule will be used as follows:

A power-driven vessel making way through the water must sound at intervals of not more than 2 minutes one prolonged blast.

A power-driven vessel underway, but stopped and making no way through the water, will sound at intervals of not more than 2 minutes two prolonged blasts in succession with an interval of about 2 seconds between them.

A vessel not under command; a vessel restricted in ability to maneuver, whether underway or at anchor; a sailing vessel; a vessel engaged in fishing, whether underway or at anchor; and a vessel engaged in towing or pushing another vessel will sound at intervals of not more than 2 minutes, three blasts in succession; namely, one prolonged followed by two short blasts.

NOTE

- In the Inland Rules, no provisions are made for a vessel constrained by its draft.
- The International Rules address vessels engaged in fishing while at anchor and vessels restricted in their ability to maneuver when carrying out work at anchor separately.

The required sound signals for these situations are the same as those addressed for the same situation in the Inland.

A vessel towed (or if more than one vessel is towed, the last vessel of the tow), if it is manned will, at intervals of not more than 2 minutes, sound four blasts in succession; namely, one prolonged blast followed by three short blasts. When practical, this signal must be



Figure 5-17.--International/inland distress signals.

C69.172

made immediately after the signal made by the towing vessel.

When a pushing vessel and a vessel being pushed ahead are rigidly connected in a composite unit, they will be regarded as a power-driven vessel and give the signals prescribed earlier for a power-driven vessel making way through the water or a vessel underway but stopped and making no way through the water.

A vessel at anchor must, at intervals of not more than 1 minute, ring the bell rapidly for about 5 seconds. In a vessel of 100 meters or more in length, the bell must be sounded in the forepart of the vessel; and immediately after the ringing of the bell, the gong must be sounded rapidly for about 5 seconds in the afterpart of the vessel. A vessel at anchor may, in addition, sound three blasts in succession; namely, one short, one prolonged, and one short blast to give warning of its position and of the possibility of collision to an approaching vessel.

In addition to giving the bell signal and, if required, the gong signal prescribed above, a vessel aground must give three separate and distinct strokes on the bell immediately before and after the rapid ringing of the bell. A vessel aground may, in addition, sound an appropriate whistle signal.

A vessel of less than 12 meters in length is not obliged to give the above-mentioned signals but, if it does not, the vessel will make some other efficient sound signal at intervals of not more than 2 minutes.

A pilot vessel, when engaged on pilotage duty, may, in addition to the signals prescribed for a power-driven vessel underway making way through the water; underway but stopped and not making way through the water; or at anchor; sound an identity signal consisting of four short blasts.

DISTRESS SIGNALS

The International and Inland Rules on signals to attract attention are almost identical. They are as follows:

If necessary to attract the attention of another vessel, any vessel may make light or sound signals that cannot be mistaken for any signal authorized elsewhere in these rules, or may direct the beam of its searchlight in the direction of the danger in such a way as not to embarrass any vessel.

NOTE

The following paragraph from the International Rules is not included in the Inland Rules:

“Any light to attract the attention of another vessel will be such that it cannot be mistaken for any aid to navigation. For that reason, the use of high-intensity intermittent or revolving lights, such as strobe lights, must be avoided”.

There is no basis in the Rules of the Road for the popular notion that the national ensign hoisted upside down is a recognized signal of distress. No man-of-war would ever subject the colors to this indignity. But if you should see a private craft with the ensign hoisted upside down, it is probably in distress. See figure 5-17 for distress signals under the International and Inland Rules. The signals in figure 5-17 may be used or exhibited either together or separately, to indicate distress and need of assistance.

NOTE

There is no provision in the International Rules for the distress signal shown in figure 5-18.

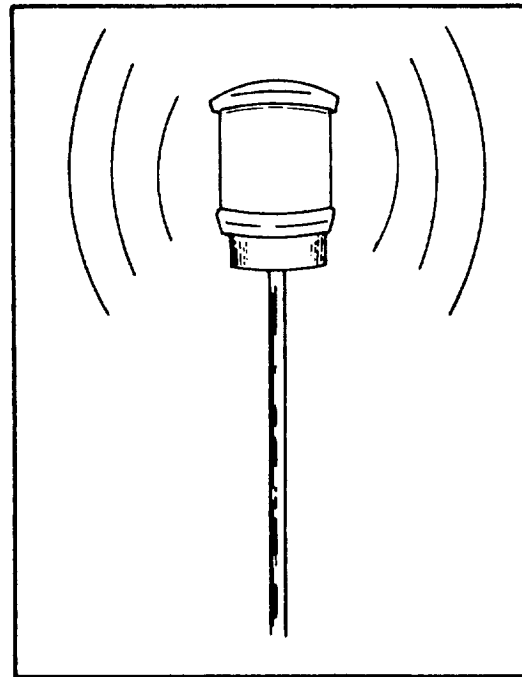

Figure 5-18.—A high-intensity white light flashing at regular intervals from 50 to 70 times per minute.

The International and Inland Rules contain the following supplemental information:

Except for indicating distress and need of assistance, the use or exhibition of any of the foregoing distress signals and the use of other signals that may be confused with any of the those signals is prohibited.

Note the relevant sections of the *International Code of Signals*, Pub. 102, the *Merchant Ship Search and Rescue Manual*, and the following signals:

- A piece of orange-colored canvas with either a black square and circle or other appropriate symbol (for identification from the air) (fig. 5-17), or
- a dye marker (fig. 5-17).

The following signals, although not part of the Rules of the Road, are prescribed for submerged submarines in emergency situations involving rising to periscope depth or surfacing:

- A white or yellow smoke flare fired into the air from a submarine indicates the submarine is coming to periscope depth to carry out surfacing procedures. Ships should clear the immediate vicinity but should not stop propellers.
- A red smoke flare fired into the air from a submarine is a signal that the submarine is in serious trouble and will surface immediately if possible. Smoke flares of any color, fired into the air at short intervals, mean the submarine requires assistance. All ships in the area should clear the immediate vicinity but stand by to give aid.

BUOYS

LEARNING OBJECTIVES: Define buoys. Recognize the International Buoyage Regions. Describe the IALA Maritime Buoyage System including buoy types, buoy colors, and buoy markings.

Buoys are moored floating markers placed so as to guide ships in and out of channels, warn them away from hidden dangers, and lead them to anchorage areas, and so forth. Buoys may be of various sizes and shapes. Regardless of their shapes, however, their distinctive coloring is the chief indication of their purposes.

Large automatic navigational buoys (LANBYs) are major aids to navigation, and they provide light, sound

signal, and radio beacon service. The LANBY is an all steel disk-shaped hull 40 feet in diameter. The light, sound signal, and radio beacon are located on the mast.

Although buoys are valuable aids to navigation, they must never be depended upon exclusively. Buoys frequently drag their moorings in heavy weather, or they may be set adrift when run down by passing vessels. Lights on lighted buoys may go out of commission. Whistles, bells, and gongs actuated by the sea's motions may fail to function in smooth water.

INTERNATIONAL BUOYAGE REGIONS

To reach agreement with all maritime countries to bring all buoyage into one system with the least amount of money and time expended, two international buoyage regions were established. Figure 5-19 outlines International Buoyage Regions A and B. Navigational charts produced and/or printed after 1983 indicate the buoyage region to which the chart refers.

MARITIME BUOYAGE SYSTEM

Until recently, as many as 30 different buoyage systems were in use around the world. In 1982, most of the maritime nations of the world signed an agreement sponsored by the International Association of Lighthouse Authorities (IALA). This agreement adopted a system known as the IALA Maritime Buoyage System. The system provides rules that apply to all fixed and floating marks other than lighthouses, sector lights, range lights, lightships, and large automatic navigational buoys (LANBYs).

The Maritime Buoyage System provides five types of marks that may be used in any combination. The five types of marks are lateral, cardinal, isolated danger, safe water, and special. Each type of mark will be discussed briefly here and in more detail later.

1. Lateral marks—indicate the port and starboard hand sides of channels. Within the Maritime Buoyage System there are two international buoyage regions where lateral marks differ. These buoyage regions and the different lateral marks will be discussed in detail later in this chapter.

2. Cardinal marks—used in conjunction with the compass, indicate that the navigable water lies to the named side of the mark

3. Isolated danger marks—erected on, or moored directly on or over, dangers of limited size.

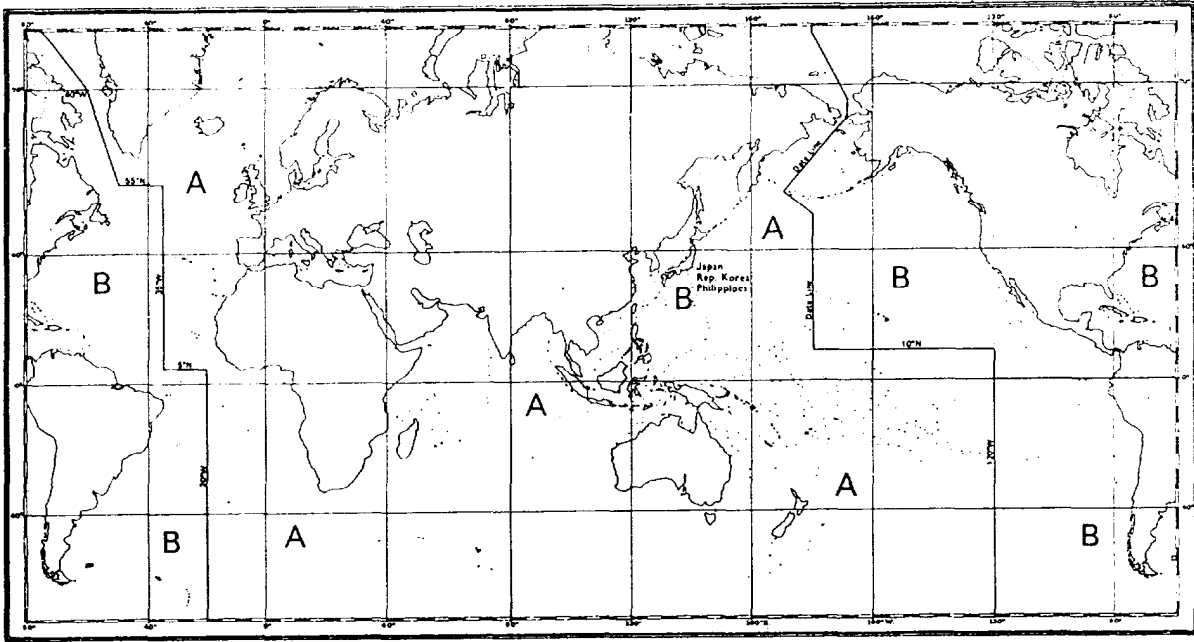

Figure 5-19.—IALA Maritime Buoyage System, Buoyage Regions A and B.

4. Safe water marks—used to indicate that there is water safe for navigation all around the position (examples: midchannel and fairways).

5. Special marks—call attention to an area or specific feature. Explanation of special marks may be found on the navigational chart you are using, in *Sailing Directions*, or in *Coast Pilots*.

Distinguishing Marks

The meaning of the mark depends upon one or more of the following features:

1. By day—color, shape, and topmark
2. By night—light color and phase characteristics

COLOR.— The colors used for lateral marks in Region A are red, green, green with one red horizontal band, and red with one green horizontal band.

The colors used for lateral marks in Region B are green, red, red with one green horizontal band, and green with one red horizontal band.

SHAPE.— There are five basic buoy shapes (fig. 5-20): can, nun, spherical, pillar, and spar. With the exception of pillar and spar buoys, the shape of the buoy indicates the correct side on which to pass. Can buoys may sometimes be referred to as cylindrical, and nun buoys referred to as conical. The term pillar is used to describe any buoy that is smaller than a lighthouse buoy

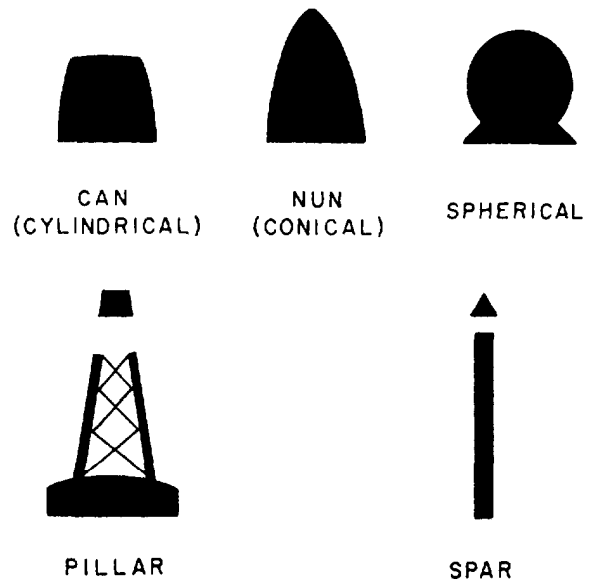

Figure 5-20.—Basic buoy shapes.

but has a tall, central structure on a broad base. Lighted buoys in the United States are referred to as pillar buoys.

TOPMARKS.— The IALA Maritime Buoyage System makes use of can, nun, spherical, and X-shaped topmarks only. Topmarks on pillar and spar buoys are particularly important to indicate the side on which they will be passed and will be used wherever practical.

LIGHTS.— Where marks are lighted, red and green lights are reserved for port and starboard or starboard

and port lateral marks. Yellow lights are for special marks, and white lights are used for other types of marks, which will be discussed later in this chapter.

PHASE CHARACTERISTICS.— Lights, when fitted, may have any of the following phase characteristics (or frequency of duration): quick flashing, flashing, long flashing, or group flashing.

Lateral Marks

Lateral marks are generally used for well-defined channels. They indicate the route to be followed and are used in conjunction with a “conventional direction of buoyage.” This direction is defined in one of two ways:

- Local direction of buoyage—the direction taken by the mariner when approaching a harbor, river estuary, or other waterway from seaward.
- General direction of buoyage—in other areas, a direction determined by the buoyage authorities, following a clockwise direction around continental landmasses, given in *Sailing Directions*, and, if necessary, indicated on charts by a symbol.

The numbering or lettering of buoys is an optional feature. In the United States, fairway and channel buoys are always numbered odd to port and even to starboard, approaching from seaward. Table 5-3 shows the aids used by the United States.

REGION A.— As shown in figure 5-19, International Buoyage Region A covers Europe and Asia with the exception of Japan, the Republic of Korea, and the Republic of the Philippines. The major rule to remember in this region is red to port when returning from seaward. The lateral marks (buoys) used in Region A are as follows:

Port-hand marks (fig. 5-21)

- Color: Red
- Shape (buoys): Can, pillar, or spar
- Topmark (when required): Single red can
- Light (when fitted):
 - Color: Red
 - Phase Characteristics: Any other than Composite Group Flashing (2 + 1)

Starboard-hand marks (fig. 5-22)

- Color: Green
- Shape (buoys): Nun, pillar, or spar

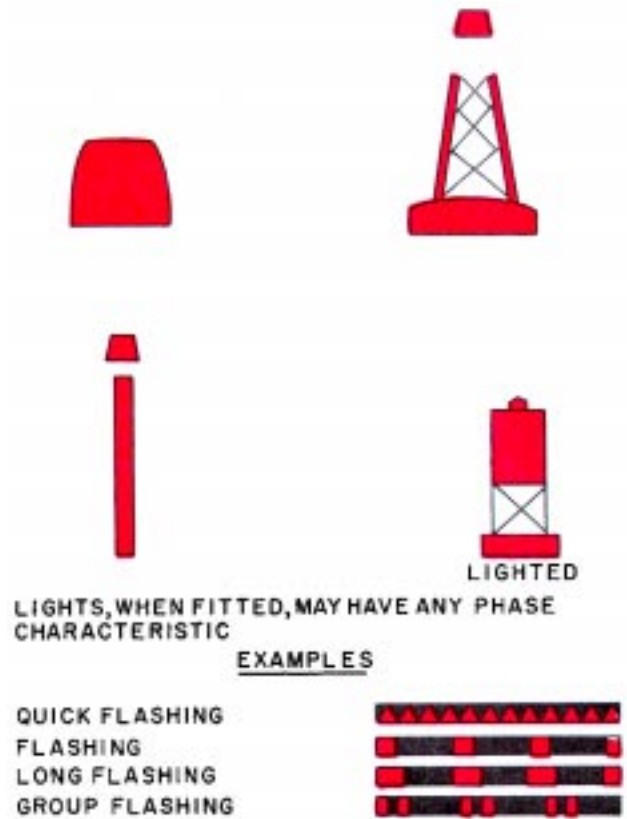

Figure 5-21.—IALA Maritime Buoyage System, International Buoyage Region A port-hand marks (buoys). C69.214

- Topmark (when required): Single green cone, point upward
- Light (when fitted):
 - Color: Green
 - Phase Characteristics: Any other than Composite Group Flashing (2 + 1)

When the ship is proceeding in the conventional direction of buoyage, a preferred channel may be indicated by a modified port or starboard lateral mark at the point where a channel divides.

Preferred channel to port (fig. 5-23)

- Color: Green with one broad red horizontal band
- Shape (buoys): Nun, pillar, or spar
- Topmark (when required): Single green cone, point upward
- Light (when fitted):
 - Color: Green
 - Phase Characteristics: Composite Group Flashing (2 + 1)

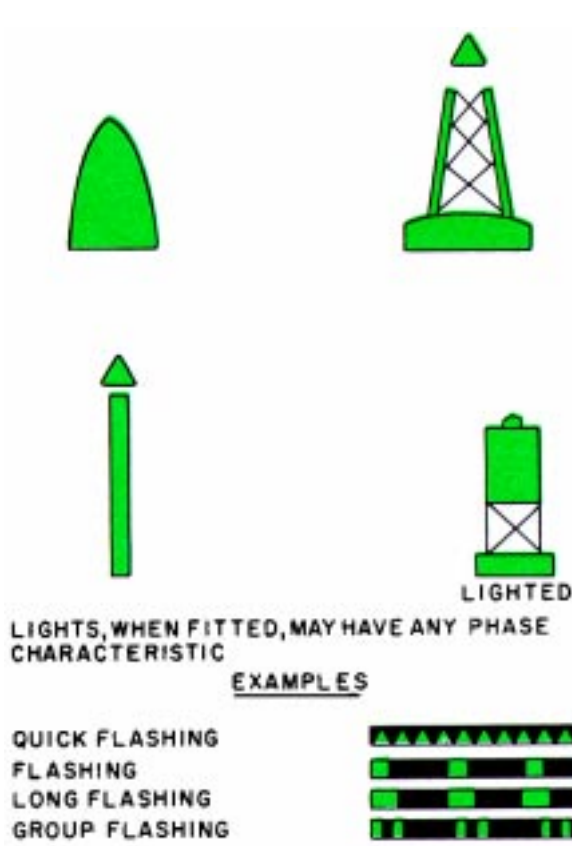

Figure 5-22.—IALA Maritime Buoyage System, International Buoyage Region A starboard-hand marks (buoys).

C69.215

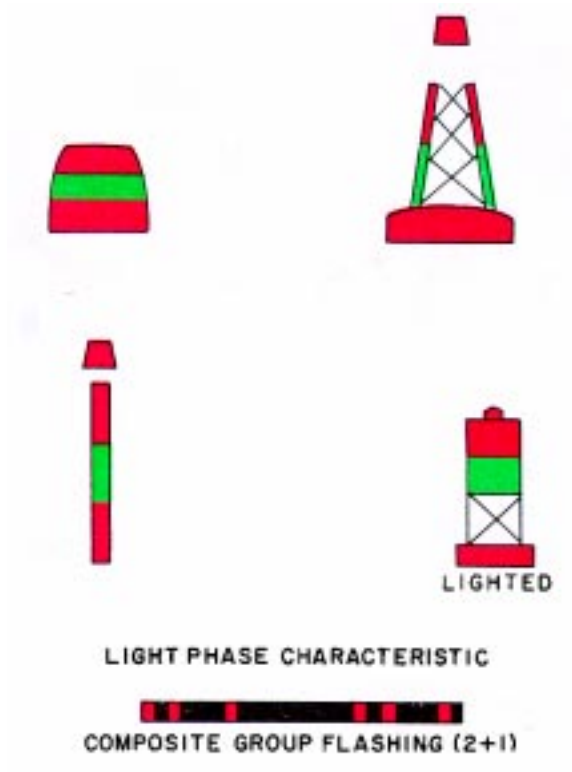

Figure 5-24.—IALA Maritime Buoyage System, International Buoyage Region A preferred channel to starboard.

C69.217

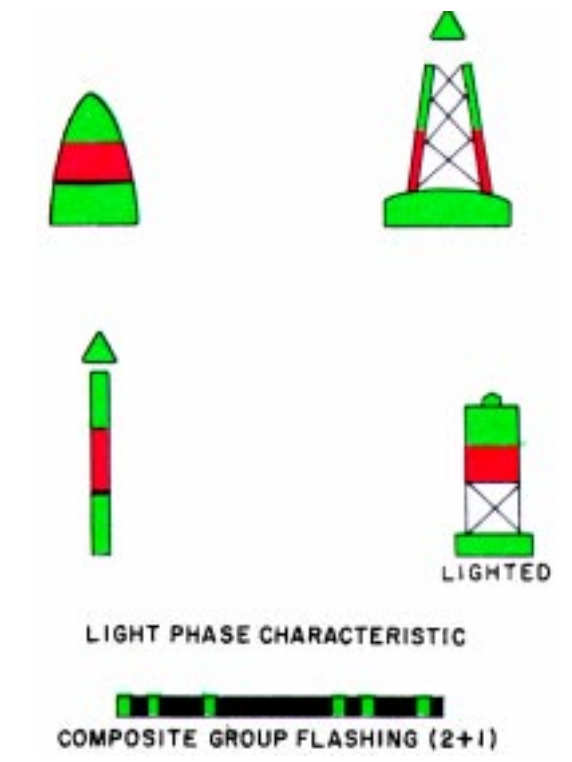

Figure 5-23.—IALA Maritime Buoyage System, International Buoyage Region A preferred channel to port.

C69.216

Preferred channel to starboard (fig. 5-24)

- Color: Red with one broad green horizontal band
- Shape (buoys): Can, pillar, or spar
- Topmark (when required): Single red can
- Light (when fitted): Color: Red
- Characteristics: Composite Group Flashing (2 + 1)

REGION B.— Basically, Region B (refer to fig. 5-19) covers the Western Hemisphere, Japan, the Republic of Korea, and the Philippines. The main rule to remember in this region is red right returning from seaward. The lateral marks (buoys) used in Region B are as follows:

Port-hand marks (fig. 5-25)

- Color: Green
- Shape (buoys): Can, pillar, or spar
- Topmark (when required): Single green can
- Light (when fitted): Color: Green
- Phase Characteristics: Any other than Composite Group Flashing (2 + 1)

Table 5-3.—Markings from the IALA Maritime Buoyage Systems incorporated into the U.S. Aids to Navigation

<p>Starboard-hand Lateral Aids: Color: Red Shape: Nun or Lighted Light (when fitted): Red Rhythm: Any, other than Comp Gp Fl (2+ 1) Changes: Lights-from white or red to red only</p>
<p>Port-hand Lateral aids: Color: Green Shape: Can or Lighted Light (when fitted): Green Rhythm: Any, other than Comp Gp Fl (2+1) Changes: Color-From black to green Lights-From white or green to green only</p>
<p>Preferred Channel to Starboard: Color: Horizontally banded green over red over green Shape: Can or Lighted Light (when fitted): Green Rhythm: Comp Gp Fl (2+1) Changes: Color-From black to green Lights-From white or green to green only Light rhythm-From I Qk Fl to Comp Fl (2+1)</p>
<p>Preferred Channel to Port: Color: Horizontally banded red over green over red Shape: Nun or lighted Light (when fitted): Red Rhythm: Comp Gp Fl (2+1) Changes: Color-From black to green Lights-From white or red to red only Light rhythm-From I Qk Fl to Comp Gp Fl (2+1)</p>
<p>Safe Water: Color: Vertically striped red-and-white Shape: Spherical or lighted (if lighted, red topmark) Topmark (when required): Single red sphere Light (when fitted): White Rhythm: Morse A Changes: Color-From black-and-white to red-and-white Shape-Nonspherical buoys will have topmark Nun and can buoys will not</p>
<p>Special Purpose: Color: Yellow Shape: Optional, but not conflicting with navigational mark Light (when fitted): Yellow Rhythm: Any, other than Qk Fl, Gp Qk Fl, Gp Qk & L Fl, V Qk Fl, Gp V Qk Fl, Gp V Qk Fl & L FL, Gp Fl (2) Iso, Occ, L Fl, MO (A), or MO (U) Changes: Color-From various color combinations to yellow All special-purpose aids will be yellow and, when lighted, will use yellow lights</p> <p>Information and Regulatory Markers: No Change</p>

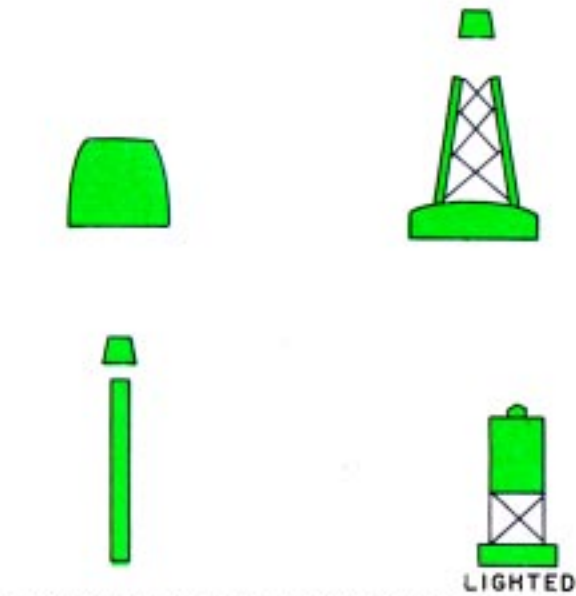

LIGHTS, WHEN FITTED, MAY HAVE ANY PHASE CHARACTERISTIC

EXAMPLES

QUICK FLASHING
FLASHING
LONG FLASHING
GROUP FLASHING



C69.218

Figure 5-25.—IALA Maritime Buoyage System, International Buoyage Region B port-hand marks (buoys).

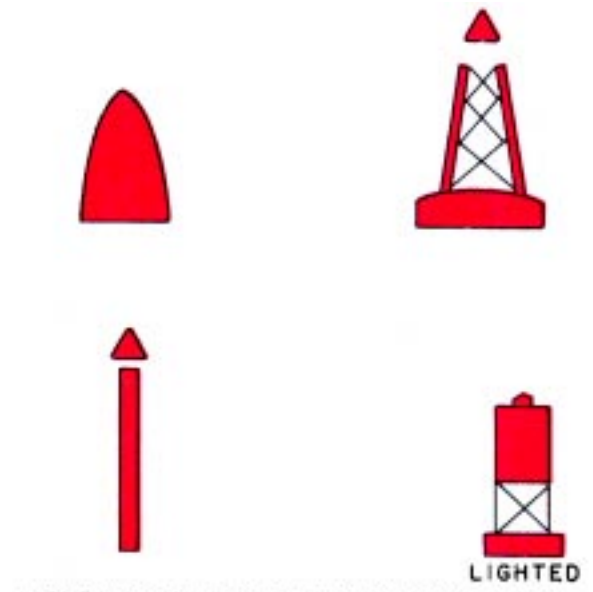

LIGHTS, WHEN FITTED, MAY HAVE ANY PHASE CHARACTERISTIC

EXAMPLES

QUICK FLASHING
FLASHING
LONG FLASHING
GROUP FLASHING



C69.219

Figure 5-26.—IALA Maritime Buoyage System, International Buoyage Region B starboard-hand marks (buoys).

Starboard-hand marks (fig. 5-26)

Color: Red

Shape (buoys): Nun, pillar, or spar

Topmark (when required): Single red cone, point upward

Light (when fitted):

Color: Red

Phase Characteristics: Any other than Composite Group Flashing (2 + 1)

Preferred channel to port (fig. 5-27)

Color: Red with one broad green horizontal band

Shape (buoys): Nun, pillar, or spar

Topmark (when required): Single red cone, point upward

Light (when fitted):

Color: Red

Phase Characteristics: Composite Group Flashing (2 + 1)

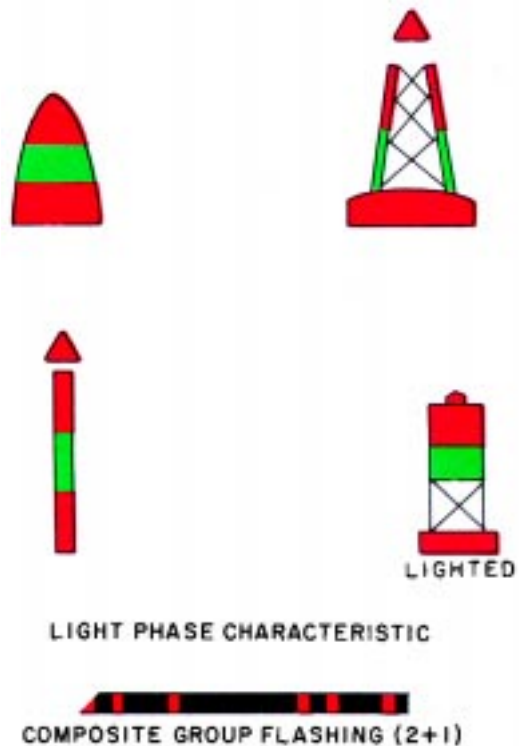

LIGHT PHASE CHARACTERISTIC

COMPOSITE GROUP FLASHING (2+1)

C69.220

Figure 5-27.—IALA Maritime Buoyage System, International Buoyage Region B preferred channel to port.

Preferred channel to starboard (fig. 5-28)

Color: Green with one broad red horizontal band

Shape (buoys): Can, pillar, or spar

Topmark (when required): Single green can

Light (when fitted):

Color: Green

Phase Characteristics: Composite Group Flashing
(2 + 1)

NOTE

In buoyage Regions A and B, if marks at the sides of a channel are numbered or lettered, the numbering or lettering will follow the conventional direction of buoyage.

Cardinal Marks

Cardinal marks are used in conjunction with the compass to indicate the best navigable water. A cardinal mark is placed in one of the four quadrants (north, east, south, or west) from the best water. A cardinal mark

takes its name from the compass point in which it is placed. Figure 5-29 shows the IALA Maritime Buoyage System cardinal marks (buoys).

Mariners are safe if they pass north of a north mark, east of an east mark south of a south mark and west of a west mark. A cardinal mark may be used to accomplish the following:

- Indicate that the deepest water is an area on the named side of the mark
- Indicate the safe side on which to pass a danger
- Draw attention to a feature in a channel, such as a bend, junction, branch, or end of a shoal

TOPMARK.— By day, topmarks are the most important features of cardinal marks. The arrangement of the cones must be memorized. For north, the point of each cone is up. For south, the point of each cone is down. An aid to help you memorize the west topmark is its resemblance to a wine glass. Cardinal marks carry topmarks, whenever practical, with the cones as large as possible and clearly separated.

COLOR.— Black and yellow horizontal bands are used to color cardinal marks. The position of the black band, or bands, is related to the points of the black topmarks. The black and yellow horizontal bands are used as follows:

North—Black band above yellow band

South—Black band below yellow band

West—Black band with yellow bands above and below

East—Black band above and below yellow band

The shape of a cardinal mark is not important, but in the case of a buoy, it will be pillar or spar.

LIGHT CHARACTERISTICS— When lighted, a cardinal mark exhibits a white light. The characteristics are based on a group of quick (Qk) or very quick (Vqk) flashes that distinguish the light as a cardinal mark and indicate its quadrant. The distinguishing quick or very quick flashes are as follows:

North—Very quick flashing (Vqk) or quick flashing (Qk)

East—Very quick flashing every 5 seconds (Vqk [3] 5s) or quick flashing every 10 seconds (Qk [3] 10s)

South—Very quick flashing followed by a long flash every 10 seconds (Vqk FL [6] + LF1 10s) or quick

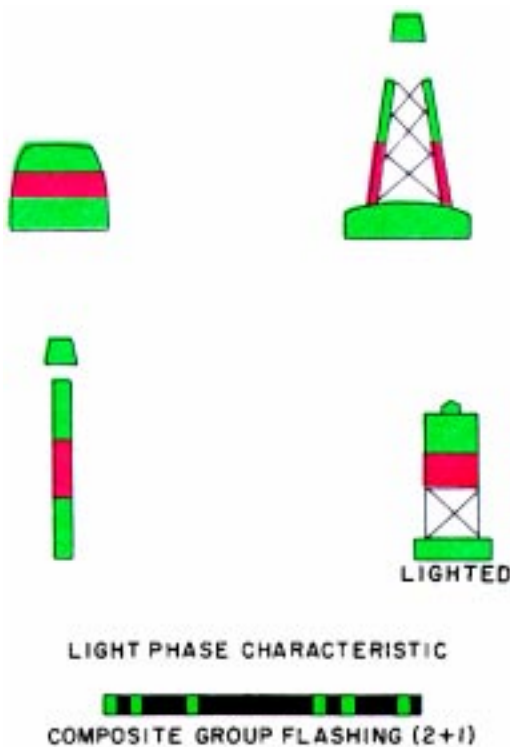

C69.221

Figure 5-28.—IALA Maritime Buoyage System, International Buoyage Region B preferred channel to starboard.

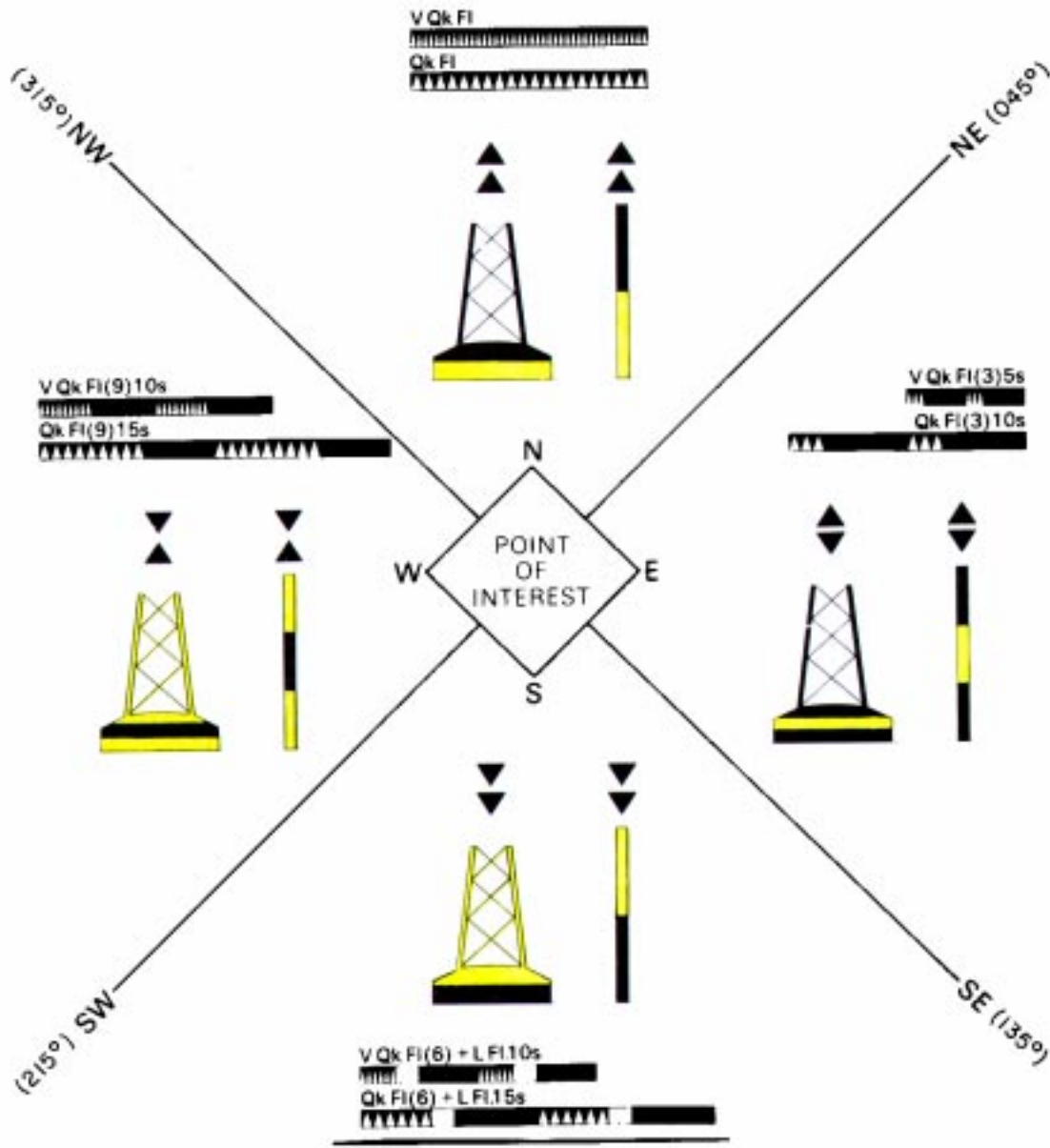

C69.222

Figure 5-29.-IALA Maritime Buoyage System cardinal marks.

flashing followed by a long flash every 15 seconds (Qk [6] + LF1 15s)

West-Very quick flashing every 10 seconds (Vqk [9] 10s) or quick flashing every 15 seconds (Qk [9] 15s)

As a memory aid, associate the number of flashes in each group with a clock face (3 o'clock-east, 6 o'clock-south, and 9 o'clock-west).

The long flash immediately following the group of flashes of a south cardinal mark is to

ensure that its six flashes cannot be mistaken for three or nine.

Quick flashing lights flash at the rate of either 60 or 50 flashes per minute. Very quick flashing lights flash at the rate of either 120 or 100 flashes per minute. It is necessary to have a choice of quick flashing or very quick flashing lights to avoid confusion. Two north buoys that are placed near enough to each other to be mistaken is one example where the quick flashing and very quick flashing lights would be needed.

Isolated Danger Marks

Isolated danger marks (fig. 5-30) are erected on, or moored above, an isolated danger of limited extent. The isolated danger mark has navigable water all around it. The extent of the surrounding navigable water is not important. The isolated danger mark, for example, indicates either a shoal that is well offshore or an islet separated by a narrow channel from the coast.

A black double-sphere topmark is, by day, the most important feature of an isolated danger mark. Whenever practical, this topmark will be carried with the spheres as large as possible, mounted vertically, and clearly separated.

Black, with one or more red horizontal bands, is used for isolated danger marks. The shape of an isolated danger mark is not significant, but, in the case of a buoy, it will be a pillar or spar.

When lighted, a white flashing light showing a group of two flashes (F1 [2]) is used to denote an isolated danger mark. The association of two flashes and two spheres in the topmark may be a help in remembering these characteristics.

Safe Water Marks

Safe water marks (fig. 5-31) are used to indicate that there is navigable water all around the mark. Such a



C69.223

Figure 5-30.—IALA Maritime Buoyage System isolated danger marks.

mark may be used as a centerline, midchannel, or landfall buoy.

Red and white vertical stripes are used for safe water marks. The vertical stripes are used to distinguish them from the black-banded danger marks. Spherical, pillar, or spar buoys may be used as safe water marks. Whenever practical, a pillar or spar buoy used as a safe water mark will carry a single red sphere topmark.

When lighted, a safe water mark exhibits a white light. The phase characteristics of the light will be occulting, equal interval (isophase), one long flash every 10 seconds, or Morse A. The association of a single flash and a single sphere in the topmark may help to remember these characteristics.

Special Marks

Special marks (fig. 5-32) may be used to indicate a special area or feature. The nature of the special area or feature may be found by consulting the navigational chart being used.

Notice to Mariners. The uses of a special mark include the following:

- Ocean Data Acquisition System (ODAS), buoys carrying oceanographic or meteorological sensors
- Traffic separation marks
- Spoil ground marks
- Military exercise zone marks
- Cable or pipeline marks, including outfall pipes
- Recreation zone marks

Another function of a special mark is to define a channel within a channel (for example, a channel for deep-draft vessels in a wide approach area where the limits of the channel for normal navigation are marked by red and green lateral buoys).

Topmark
(always fitted* if buoy
is not spherical)

Shape: spherical
or
pillar or spar



Light, when fitted, is
white
Isophase or Occulting,
or Long Flashing every
10 seconds

Iso
Occ
L Fl. 10s

C69.224

Figure 5-31.—IALA Maritime Buoyage System safe water marks.

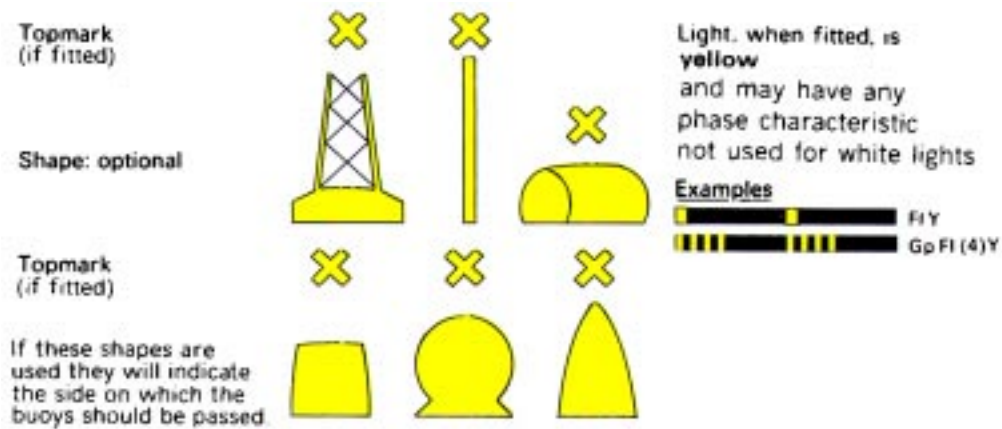

C69.225

Figure 5-32.— IALA Maritime Buoyage System special marks.

Yellow is the color used for special marks. The shape of a special mark is optional, but it must not conflict with a lateral or a safe water mark. For example, an outfall buoy on the port-hand side of a channel could be can shaped but not conical.

When a topmark is carried, it takes the form of a single yellow X. When a light is exhibited, it is yellow. The phase characteristics may be any, other than those used for the white lights of cardinal, isolated danger, and safe water marks.

Daymarks

Unlighted aids to navigation (except unlighted buoys) are called daymarks (fig. 5-33). A daymark may consist of a single piling with a mark on top, a spar supporting a cask, a slate or masonry tower, or any of several structures.

Daymarks, like lighthouses, are usually colored to distinguish them from their surroundings and make them easy to identify. Daymarks marking channels are colored and numbered like channel buoys. Many are fitted with reflectors that show the same colors that a lighted buoy would show at night in the same position.

Intracoastal Waterway

The Intracoastal Waterway, called the inland waterway, is a channel in which a light-draft vessel can navigate coastwise from the Chesapeake Bay almost to the Mexican border, remaining inside the natural or artificial breakwaters for almost the entire length of the trip.

Every buoy, daymark, or light structure along the Intracoastal Waterway has part of its surface painted

yellow, the distinctive coloring adopted for this waterway. Somewhere on a lighted buoy is a band or a border of yellow.

Red buoys and daymarks are to the right, green to the left, as you proceed from the Chesapeake Bay toward Mexico. As in other channels, red buoys have even numbers; green buoys, odd numbers. Because the numbers would increase excessively in such a long line of buoys, they are numbered in groups that usually contain no more than 200 buoys. At certain natural dividing points, numbering begins again at 1.

Lights on buoys in the Intracoastal Waterway follow the standard system of red lights on red buoys and green lights on green buoys. Lights on other lighted aids agree with the standard rules for lights on aids to navigation.

Ranges

Two day beacons, located some distance apart on a specific true bearing, constitute a day beacon range. When a ship reaches a position where the two lights (or beacons) are seen exactly in line, it is “on the range.” Ranges are especially valuable for guiding ships along the approaches to or through narrow channels. Much of the steering through the Panama Canal is accomplished on ranges. Other examples of successive straight reaches marked by ranges are the channel entrances to the St. Johns River (on the Atlantic coast) and the Columbia River (on the Pacific coast).

Lights on ranges may show any of the four standard colors, and they may be fixed, flashing, or occulting. Most range lights appear to lose intensity rapidly as a ship diverges from the range line of bearing.

When steering on a range, it is highly important that you ascertain the limit beyond which the range line of

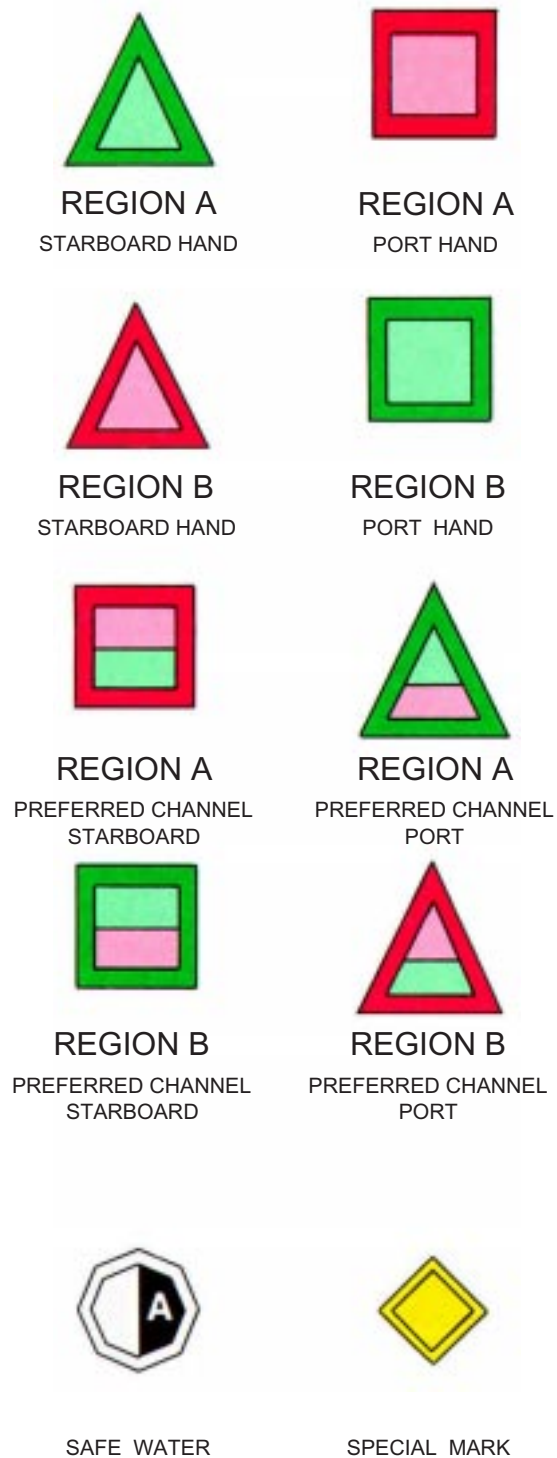

Figure 5-33.-IALA Maritime Buoyage System lateral daymarks. C69.226

bearing cannot be followed safely. This information is available on the navigation chart being used.

Fog Signals

Most lighthouses and LANBYS are equipped with fog-signaling apparatus, ordinarily sounded automatically by mechanical and electrical means. For identification purposes, each station has its own assigned number of blasts, recurring at specified intervals. A definite time is required for each station to sound its entire series of blasts; this timing provides another means of identification.

The various types of apparatus produce corresponding variance of pitch and tone, thus giving your ear a chance to compare the sound of a station with its description in the *Light Lists*, published by the U.S. Coast Guard. A thorough knowledge of the lights and buoyage system is important because you will be, at one time or another, assigned to lookout duties as a bridge watchstander, or as a boat crew where knowledge of the buoy system is used extensively.

SUMMARY

The knowledge and experience you acquire as a Seaman today will help you to do whatever job you are assigned to the utmost of your ability in the future.

As a Seaman you may be assigned to any of the numerous vessels of the U.S. fleet. Aboard most ships, your job will most likely be different from the job you left. With “hands-on” training indoctrination, you should be performing your assigned duties as well as any other Seaman.

This chapter has covered many knowledge factors relating to boat handling, including a basic knowledge of the Rules of the Road and the buoy system. You can be assured that your time at sea will be challenging and rewarding.

CHAPTER 6

AMMUNITION AND GUNNERY

Despite the present-day emphasis on missiles, guns continue to be important offensive weapons.

As a Seaman, you may be required to man gun stations or serve as a member of a magazine crew, so it is necessary that you have a general knowledge of the ammunition and guns in service.

It is not our intent, nor is it necessary, to discuss all the different types of ammunition and guns used in the Navy today. This chapter does, however, contain much information on guns, ammunition, and gunnery in general; information that should be very helpful to you in meeting your early shipboard assignments.

Excluding small arms, Naval guns are classified according to size. Within this classification, they are grouped as major, intermediate, or minor calibers. Major caliber guns range from 8 inches up to 16 inches. Intermediate calibers are greater than 3 inches and less than 8 inches. Minor caliber guns are 3 inches and below.

AMMUNITION

***LEARNING OBJECTIVE:** Define ammunition. Differentiate between the types of ammunition used aboard naval ships. Define and explain the different types of projectiles and propelling charges used in the Navy. Explain the use of the magazine and magazine sprinkler system.*

In a general sense, ammunition includes anything that is intended to be thrown at the enemy or put in his path to deter, injure, or kill personnel, or to destroy or damage materials. The term ammunition is used in a much narrower and more technical sense in this book. Ammunition includes any projectile or explosive weapon, as well as components or parts thereof, but not guns or weapon launchers and their parts.

Service ammunition is ammunition lit for service use and including all explosive and propellant components. Inert ammunition (that is, lacking explosive and propellant components) and partially inert ammunition of several types are used for test, training, and practice purposes. Dummy or drill

ammunition (completely inert) resembling service ammunition in appearance, size, and weight, may include functioning components that contain no explosive or propellant. It is used for training and test purposes. Cutaway ammunition (completely inert) has a section cut away to show inner construction and components; it is used for training and display purposes. Plaster-loaded or sand-loaded ammunition lacks the explosive burster charge but is otherwise not inert; it is used for target practice and for testing of launchers, mounts, or projectors.

IDENTIFICATION

As a member of a gun-loading crew, you will be tasked with finding, identifying, and loading different types of ammunition. Each round fired must be identified and recorded in the ship's logs. Ammunition is identified by stenciled information printed on the round and by its color. Stenciled information consists mainly of the Navy Ammunition Logistics Code (NALC)/Department of Defense Identification Code (DODIC) and lot number.

A standard nomenclature and numbering system has been established by the Department of Defense (DOD). This system is a four-digit, alphabetic/numeric code which will be either a Department of Defense identification code (DODIC) assigned by Defense Logistics Services Center (DLSC) or a Navy ammunition logistics code (NALC) assigned by Ship's Parts Control Center (SPCC). Examples of DODIC/NALC nomenclature are as follows:

AMMUNITION TYPE	DODIC/NALC
5"/54 Illumination Projectile	D328
6"/50 BL&P Projectile	D873
12 GAUGE 00 BUCKSHOT	A011

COLOR CODES, MARKINGS, AND LETTERINGS

The system of identifying ammunition by the use of color codes, marking, and lettering is intended to be a

ready identification to determine the explosive loads and hazards presented by the identified items. A color coding system is employed to indicate the primary use of ammunition, the presence of a hazardous (explosive, flammable, irritant, or toxic) filler, and/or the color of tracers, dye loads, and signals. Information on color coding for ammunition 20-mm or larger is contained in MIL-STD-709, OP 2238 (latest revision), and WS 18782. The lettering, stenciled or stamped on ammunition, includes all the information necessary for complete identification and is marked in compliance

with NATO standards and Department of Transportation (DOT) regulations. In addition to standard nomenclature and lot numbers, lettering may include such information as the mark and mod, the type of fuzes, and the weapon in which the item is fired. Table 6-1 gives the meaning of the different color codes.

CLASSIFICATION

Gun ammunition is most commonly classified by the size of the gun in which it is used. In addition to

Table 6-1.-Ammunition Color Coding

COLOR	INTERPRETATION
Yellow	1. Identifies high explosives
	2. Indicates the presence of explosive either
	a. sufficient to cause the ammunition to function as a high explosives or b. particularly hazardous to the user Brown
Brown	1. Identifies rocket motors 2. Indicates the presence of explosives either a. sufficient to cause the ammunition to funcuon as low explosive or b. particularly hazardous to the user
Gray	Identifies ammunition that contains irritant or toxic agents when used as an overall body color except for underwater ordnance
Gray with red band (s)	Indicates the ammunition contains an irritant (harassing) agent
Gray with dark green band (s)	Indicates the ammunition contains a toxic agent
Black	Identifies armor-defeating ammunition except on underwater ordnance
Silver/Aluminum	Identifies countermeasures ammunition
Light Green	Identifies smoke or marker ammunition
Light Red	Identifies incendiary ammunition or indicates the presence of highly flammable material
White	Identifies illuminating ammunition or ammunition producing a colored light; exceptions are underwater ordnance, guided missiles, and rocket motors
Light Blue	Identifies ammunition used for training or firing practice
Orange	Identifies ammunition used for tracking or recovery
Bronze	Identifies Dummy/Drill/Inert ammunition used for handling and loading training
Nonsignificant Colors	
Olive Drab	All ammunition items
Black	For lettering
White	1. For lettering 2. For guided missiles and rocker motors

designations of bore diameter, such as 20-mm, 3-inch, or 5-inch, the length of the gun bore in calibers is also used as a means of classification. Thus a 3-inch, 50-caliber projectile is one used in a gun having a bore diameter of 3 inches and a bore length of 50 times 3 inches, or 150 inches. The three types of ammunition classified by assembly are shown in figure 6-1.

Fixed Ammunition

The Fixed class of ammunition applies to ammunition that has the cartridge case crimped around the base of the projectile. The primer is assembled in the cartridge case. The projectile and the cartridge case, containing the primer and propellant charge, form one unit as a fixed round of ammunition. Small-caliber guns and guns through 3-inch, 50-caliber use fixed ammunition.

Semi-fixed Ammunition

Semi-fixed, or separated ammunition, applies to ammunition that consists of two units: the projectile assembly and cartridge case assembly. The projectile assembly consists of the projectile body containing the load, the nose fuze, the base fuze, and the auxiliary detonating fuze, as applicable. The cartridge case assembly consists of the cartridge case, primer, propellant charge, wad, distance piece, and a plug to close the open end of the cartridge case. Semi-fixed

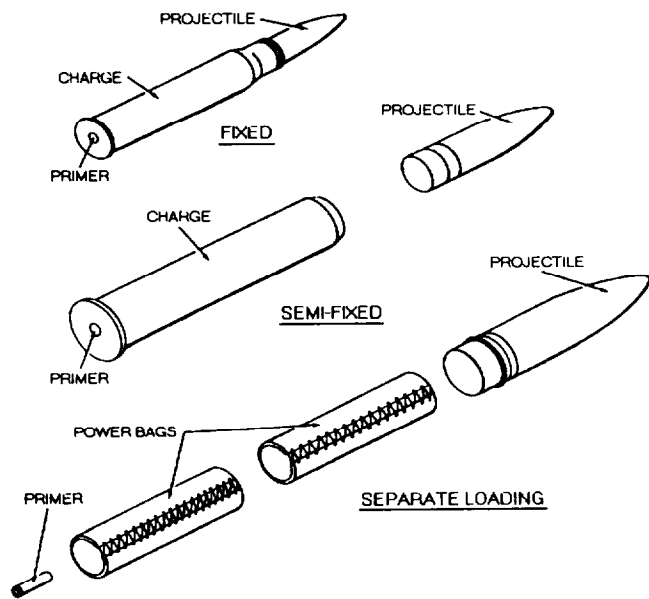

Figure 6-1.—Types of gun ammunition: fixed (top); semi-fixed (center); and separate-loading (bagged gun) (bottom).

ammunition is produced in gun sizes of 5-inch, 54-caliber through 8-inch, 55-caliber guns.

PROJECTILES

The *projectile* is that component of ammunition that, when fired from a gun, carries out the tactical purpose of the weapon. While some types of projectiles are one piece, the majority of naval gun projectiles are assemblies of several components. All of the projectiles briefly discussed by classification in this chapter have several common features, as described in the following paragraphs and as illustrated in figure 6-2.

Ogive

The *ogive* is the curved forward portion of a projectile. The curve is determined by a complex formula designed to give maximum range and accuracy. The shape of the ogive is generally expressed by stating its radius in terms of calibers. It may be a combination of several arcs of different radii.

Bourrelet

The *bourrelet* is a smooth, machined area that acts as a bearing surface for the projectile during its travel through the bore of the gun. Some projectiles have only one bourrelet (forward); the rotating band serves as the bearing surface in the rear. Other projectiles have one bourrelet forward and one or two aft, the after one being located adjacent to and either forward or aft of the rotating band. Bourrelets are painted to prevent rusting.

Body

The *body* is the main part of the projectile and contains the greatest mass of metal. It is made slightly smaller in diameter than the bourrelet and is given only a machine finish.

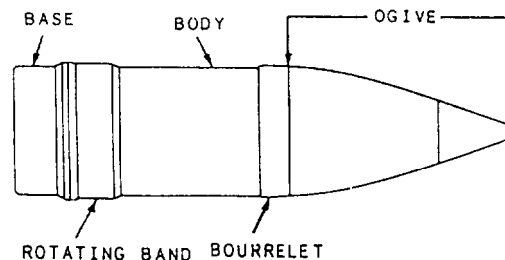

Figure 6-2.—Typical projectile, external view.

Rotating Band

The *rotating band* is circular and made of commercially pure copper, copper alloy, or plastic seated in a scored cut in the after portion of the projectile body. For all minor- and medium-caliber projectiles, rotating bands are made of commercially pure copper or gilding metal, which is 90-percent copper and 10-percent zinc. Major-caliber projectile bands are of cupro-nickel alloy, containing 2.5-percent nickel or nylon with a Micarta insert. As a projectile with a metallic band passes through the bore of the gun, a certain amount of copper will be wiped back on the rotating band and will form a skirt of copper on the after end of the band as the projectile leaves the muzzle of the gun. This is known as fringing and is prevented by cutting grooves, called *cannelures*, in the band or by undercutting the lip on the after end of the band. These cuts provide space for the copper to accumulate. The primary functions of a rotating band are (1) to seal the forward end of the gun chamber against the escape of the propellant gas around the projectile; (2) to engage the rifling in the gun bore and impart rotation to the projectile; and (3) to act as a rear bourrelet on those projectiles that do not have a rear bourrelet.

Base

The *base* is the after end of the projectile. A removable base plug is provided in projectiles that are loaded through this end. A fuze hole may be drilled and tapped in the center of the base plug. Projectiles with large openings in the nose for loading through that end require no base plug. In such cases, however, the solid base of the projectile may be drilled in the center to receive a base fuze or tracer if desired. The edge formed by the side walls and the base is usually broken slightly to give additional range. Some projectiles are tapered aft of the rotating band, a shape known as *boat-tailed*. Projectiles with plastic bands may have full caliber boat-tails for optimum aerodynamic shape.

Projectile Types

Projectiles are also classified by their tactical purpose. The following are descriptions of some of the common projectile types (fig. 6-3).

ANTIAIRCRAFT (AA).—Antiaircraft projectiles are designed for use against aircraft; they have no base fuzes. Otherwise, they are substantially the same as the high-capacity (HC) projectiles described below.

ANTIAIRCRAFT COMMON (AAC).—Antiaircraft common projectiles are dual-purpose projectiles combining most of the qualities of the AA-type with the strength necessary to penetrate mild-steel plate (fig. 6-3, view A). However, AAC projectiles do not have the penetrating ability of common projectiles. The type of fuzing will depend on the use. Fuze threads are provided in the nose and in the base. AAC projectiles are normally equipped with a mechanical time fuze (MTF) and an auxiliary detonating fuze (ADF). Dual-purpose action is accomplished by a time setting for air burst or by setting MTFs on “safe” or for a time longer than flight-to-target to permit the base detonating fuze (BDF) (delay) to function for penetration. By substituting a point detonating fuze (PDF) for the MTF, you can convert these projectiles to high-capacity for surface burst.

CHEMICAL.—Chemical projectiles may be loaded with a toxic, harassing, or smoke-producing agent. Of the smoke agents, white phosphorous (WP) is the most frequently used. WP projectiles (fig. 6-3, view B) are designed to produce heavy smoke and, secondarily, an incendiary effect. The small WP containers are expelled and then scattered by a delayed action burster charge that is ignited by a black powder expelling charge. Other chemical loads are dispersed in a similar manner.

PUFF.—Puff projectiles (fig. 6-3, view C) are nonexplosive projectiles used as practice (spotting) rounds. They are designed to produce dense smoke clouds approximating those of high-explosive rounds.

DRILL.—Drill projectiles are used by gun crews for loading drills and for testing ammunition hoists and other ammunition-handling equipment. They are made of economical, but suitable metals, and are designed to simulate the loaded service projectile represented in size, form, and weight. They may be solid or hollow. If hollow, they may be filled with an inert material to bring them to the desired weight. This latter type is closed with a base or nose plug or both, as appropriate.

DUMMY.—Dummy projectiles are reproductions of projectiles that may be produced from a variety of materials for a number of purposes. Drill projectiles are dummy projectiles in that they are not to be fired from a gun; however, all dummy projectiles are not drill projectiles. Dummy projectiles may be made for display, instruction, or special tests.

HIGH CAPACITY (HC).—High-capacity projectiles are designed for use against unarmored surface targets, shore installations, or personnel. They have a medium wall thickness and large explosive cavities.

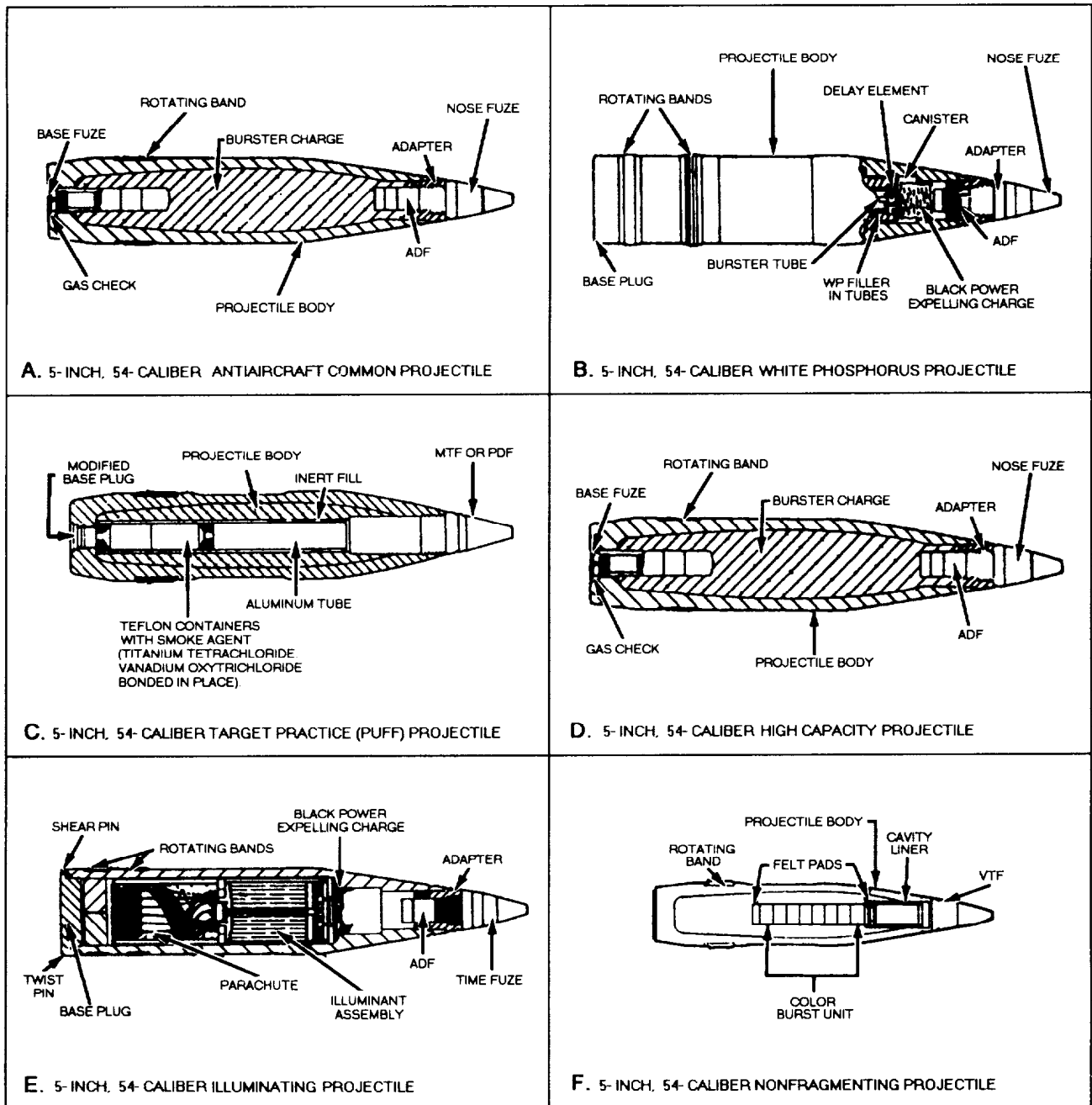

Figure 6-3.—Common projectile types.

Large HC projectiles (fig. 6-3, view D) are provided with an auxiliary booster to supplement the booster charge in the nose of the main charge. With threads in both the nose and base, HC projectiles may receive a variety of fuzes or plugs to accomplish different tactical purposes. An adapter ring (or rings) is provided on the nose end of most HC projectiles to allow installation of point detonating fuses (PDFs) or nose plug and auxiliary detonating fuses (ADFs) with different size threads. An adapter is removed for larger fuzes. HC projectiles are

normally shipped with a PDF installed in the nose. The base fuzes that are shipped installed in the projectile may not be removed except at an ammunition depot.

ILLUMINATING (ILLUM).— Illuminating projectiles (fig. 6-3, view E) are made with thin walls. Each contains a time fuze, an ADF, a small black powder expelling charge behind the ADF, an assembly consisting of a pyrotechnic star or candle with a parachute, and a lightly held base plug. The time fuze serves to ignite the expelling charge. Explosion of the

expelling charge forces out the base and the illuminating assembly, and ignites the star or candle.

VARIABLE TIME NONFRAGMENTING (VT-NONFRAG).—VT-NONFRAG projectiles (fig. 6-3, view F) are loaded to avoid rupturing the body and spreading fragments when the fuze functions; however, sometimes the projectile ogive breaks up into low-velocity fragments. They are designed for use in anti-aircraft target practice, particularly against expensive drone targets, for observing the results of firing without frequent loss of the drones. These projectiles have fillers of epsom salts or other inert material to give the projectile the desired weight. A color-burst unit, consisting of pellets of black powder and a pyrotechnic mixture, is placed in a cavity drilled in the center of the inert filler. The color burst is ignited through the action of the nose fuze and the black-powder pellets. The color-burst unit may be one of several colors that exits through the fuze cavity and ruptured projectile.

PROPELLING CHARGES

Propelling charges are mixtures of explosives designed to propel projectiles from the gun to the target. In fixed ammunition, the propelling charge and projectile are assembled together in a case and handled as one unit; the principal component parts are the brass or steel cartridge case, the primer, and a smokeless powder, the propelling charge. In the separated ammunition, the propelling charges and projectile are assembled separately; they are stored and handled as separate units until they are loaded into the gun. The propelling charge of the separated ammunition round consists of the propellant primer, details, and closure plug assembled into the metal case. The propelling charges of separate loading ammunition are made up in sections (bag charges) separate from the projectile and primer. Propelling charges for all calibers of ammunition have some common features. There are two basic categories into which these features can be grouped: case ammunition and bag charges. Saluting, reduced, and clearing charges have components that are the same as case ammunition, so they are included with case ammunition.

Case Ammunition

Propelling charges for small- and medium-caliber guns are assembled with primer and powder enclosed in a brass or steel container, called a cartridge case (fig. 6-4, view A). Assembly of the entire charge in a single, rigid, protective case increases the ease and

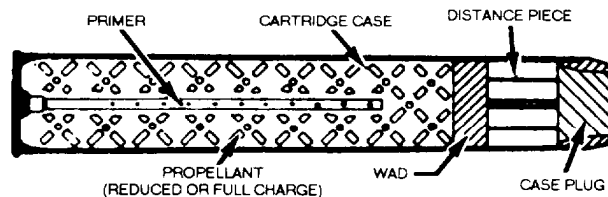

A. 5-INCH, 54-CALIBER PROPELLING CHARGE

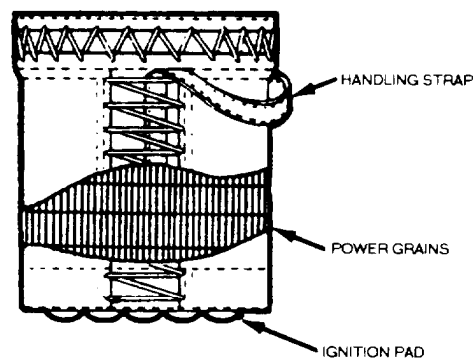

B. BAG AMMUNITION FOR A 16-INCH GUN

Figure 6-4.—Propelling charges.

rapidity of loading and reduces the danger of flarebacks. Also, the case prevents the escape of gases toward the breech of the gun; it expands from the heat and pressure of the burning powder and forms a tight seal against the chamber.

Reduced Charge

A reduced charge is one in which less than the service load of powder is placed in the cartridge case. Reduced charges may be used in target practice, to decrease the wear on the gun.

Clearing Charge

When a round fails to seat fully upon being rammed into the gun chamber, thus preventing closure of the breech, or when the propelling charge fails to function, the projectile may be fired by extracting the full-sized case and loading a shorter clearing charge.

Saluting Charge

Saluting charges are charges used when firing a gun to render honors. Since no projectile is involved in such firing, the charge consists of a cartridge case containing a black powder load and a primer. The ships normally employ 40-mm or 3-inch guns for saluting. Saluting

charges for the 40-mm and the 3-inch guns are issued completely assembled, with no replacement components.

Bag Charge

In large guns (8-inch) using separate loading ammunition, the propellant charge is made up of sections of powder contained in cylindrical cloth bags that approximate the inside diameter of the gun chamber in which they are to be used. In most cases, more than one section (bag) is required. For example, the 8-inch, 55-caliber gun uses a propellant charge consisting of two sections; the 16-inch, 50-caliber gun uses a propellant charge of six sections (fig. 6-4, view B). In these guns the leaking of gases from the chamber is checked by the mushroom and pads on the breech plug. The breech plug also contains a lock, which receives the separately loaded primer.

Fuzes

Fuzes are the components that set off the projectile bursting charge. No matter how complicated or simple the construction or function of the fuzes, they always serve the same purpose.

All fuzes use the force of inertia for arming and, in most cases, operation. Each type of fuze has a different tactical use. The use and a detailed functional description will not be covered in this text. For more information on ammunition types and their fuzes, refer to *Navy Gun Ammunition*, SW030-AA-MMO-010.

Fuzes can be generally classified by function, as discussed in the following paragraphs.

TIME FUZES.—Mechanical time fuzes (MTFs) function a predetermined length of time after the projectile is fired. The exact time is set before the projectile is loaded into the chamber, by a mechanical fuze setter on the mount, or you can set the fuze with a special fuze wrench. The interval between the instant the fuze is set and the instant the projectile is fired is dead time. No matter when, how, or by what it is set, the timing mechanism of a time fuze will not function until the projectile is fired.

PROXIMITY FUZES.—Proximity (variable time (VT)) fuzes are energized after the projectile is fired and function when the projectile nears the target.

PERCUSSION FUZES.—Percussion (impact) fuzes function as the projectile strikes the target or (especially an armor-piercing projectile) after the projectile penetrates. Some fuzes (nondelay type)

function immediately on contact with any thin material (for example, the thin sheet metal skin of an aircraft). Fuzes for armor-piercing projectiles, however, always incorporate a slight delay to keep the burster from going off until after penetration. These percussion fuzes can be located either on the nose (PDF) or on the base (BDF) of the projectile.

COMBINATION FUZES.—Combination fuzes incorporate both time and percussion features; that is, the fuzes may go off either on impact or after the time set, whichever occurs first.

AUXILIARY DETONATING FUZES.—Auxiliary detonating fuzes (ADF), as the name implies, operate only with other fuzes. In gun projectiles, they form part of the explosive train and pass on the explosion initiated by another fuze (located in the projectile nose) to the main bursting charge.

MAGAZINES

The term *magazine* applies to any compartment, space, or locker that is used or is intended to be used for the stowage of explosives or ammunition of any kind.

The term *magazine area* includes the compartment, spaces, or passages on board ship that contain magazine entrances and that are intended to be used for the handling and passing of ammunition. The term is also used to denote areas adjacent to, or surrounding, explosive stowages, including loaded ammunition lighters, trucks, and railroad cars, where applicable safety measures are required.

Magazines are arranged with regard to ease of supply, the best obtainable protection, and the most favorable stowage conditions.

Magazine Types

Many different types of magazines are provided on ships. Each magazine is designed specifically for the type of ammunition it is to contain. For our purpose, however, we will be concerned with only three types: primary magazine, ready-service magazine, and ready-service stowage.

PRIMARY MAGAZINES.—Primary magazines are designed as ammunition stowage spaces generally located below the main deck and, if possible, below the waterline. They are adequately equipped with insulation, ventilation, and sprinkler systems. These spaces must be provided with fittings so that they may be securely locked. Primary magazines accommodate a

vessel's complete allowance of ammunition for peacetime operation.

READY-SERVICE MAGAZINES.—Ready-service magazines are spaces physically convenient to the weapons they serve. They provide permanent stowage for part of the ammunition allowance. They are normally equipped with insulation, ventilation, and ammunition sprinkler systems, and should be secured by locking. The combined capacities of primary and ready-service magazines are normally sufficient to stow properly the allowance for war and emergencies.

READY-SERVICE STOWAGE.—Ready-service stowages are those ammunition stowage facilities in the immediate vicinity of the weapon served. They include weather deck lockers, bulwark (gun shield) racks, and 5-inch upper handling rooms. This stowage normally is filled only when the weapon is to be fired. There is little security for ammunition in such stowage, and it provides the least favorable protection from the elements.

Magazine Sprinkler Systems

As a member of a magazine crew, you may be trained to operate the magazine sprinkler systems protecting your magazine. You must be PQS qualified to operate any sprinkler system. Do not tamper with any sprinkler system controls unless you have been thoroughly trained, certified, and instructed to do so by competent authority according to your ship's instructions.

Sprinkler systems are used for emergency cooling of, and firefighting in, magazines, ready-service rooms, ammunition, and missile-handling areas. A magazine sprinkler system consists of a network of pipes secured to the overhead and connected by a sprinkler system control valve to the ship's saltwater firemain. The pipes are fitted with spray heads or sprinkler head valves that are arranged so that the water forced through them showers all parts of the magazine or ammunition and missile handling areas. A modern sprinkler system can wet down all exposed bulkheads at the rate of 2 gallons per minute per square foot and can sprinkle the deck area at the rate of 4 gallons per minute per square foot. Magazine sprinkler systems are designed so that they are capable of completely flooding their designated spaces within an hour. To prevent unnecessary flooding of adjacent areas, all compartments equipped with sprinkler systems are watertight. Upper deck handling and ready-service rooms are equipped with drains that limit the maximum water level to a few inches. Magazines are completely enclosed; if flooded, they

would be exposed to the full firemain pressure. The firemain pressure on most ships is considerably higher than the pressure that magazine bulkheads could withstand; therefore, magazines are equipped with exhaust ventilators, which are located in the bulkhead near the overhead. An *exhaust ventilator* is a pipe with a check valve that permits pressure release (usually to the topside). Since the diameter of the pipe is large enough to allow water to flow out as fast as it flows in, no excess pressure can build up in the magazine compartment.

Magazines are also equipped with small, capped drainpipes located in the bulkhead near the deck. The caps may be removed in the adjacent compartment to drain flooded magazines.

The sprinkler system control valve and associated components vary in complexity with the type of ship, type of stowage, and type of ammunition or missile stowed in the magazine.

PYROTECHNICS

LEARNING OBJECTIVE: Define pyrotechnic. List and explain the different types of pyrotechnics pistols and pyrotechnics used aboard ship. Explain the storage and handling procedures for pyrotechnics.

Pyrotechnic is the Greek word for fireworks. The Navy uses fireworks not for celebration but for illumination, marking, and signaling. An example is the illuminating projectile, or star shell, used to illuminate targets for gunfire. A star shell actually is a pyrotechnic device, although it is encased in a projectile body of standard external shape and is fired from a standard rifled gun.

In the following sections, we discuss the common pyrotechnic devices currently in use on modern Navy surface ships. For further information on these and other pyrotechnic devices used by the Navy, refer to *Pyrotechnic, Screening, Marking, and Countermeasure Devices*, NAVSEA SW050-AB-MMA-010. All the pyrotechnics we study here are intended for signaling and marking. We discuss the following:

- Marine location markers
- Marine illumination signals and the pyrotechnic pistols and projectiles used in firing them

Also, at the end of this section on pyrotechnics, we provide some basic information on the proper handling and storage of these devices.

MARINE LOCATION MARKERS

Marine location markers are used as night or day long-burning reference markings on the ocean's surface. They are dropped over the side from surface ships for man-overboard marking, navigation drills, and other similar operations. These markers may also be dropped from aircraft for search and rescue operations. The two marine location markers currently in use are the Mk 58 and the Mk 6.

Mk 58 Marine Location Marker

The Mk 58 marine location marker is the primary marine location marker found aboard surface vessels. It is approximately 21 1/2 inches long and weighs about 12 3/4 pounds. It contains a battery squib, some starter mix, two pyrotechnic candles, and a transfer fuse between the two candles. Before launching, the tear tape over the water port must be removed so that seawater can enter to activate the battery. Battery current energizes the electric squib, which ignites the starter

mix, which, in turn, lights the pyrotechnic candle. When the first candle has burned out (in 20 to 30 minutes), the second candle is started by the transfer fuse, for a total burning time of approximately 40 to 60 minutes. The Mk 58 currently is available in two versions: the Mod 0 and the Mod 1. The Mod 0 is a hermetically sealed can, which is opened with a twist key. Figure 6-5 illustrates this marker. The Mod 1 (fig. 6-6) is capped with a replaceable polyethylene cover.

Mk 6 Marine Location Marker

The Mk 6 aircraft smoke and illumination signal (fig. 6-7) is a pyrotechnic device that is launched from surface craft only to produce a day or night floating reference point. One of its principal uses is as a man-overboard marker. It was previously approved for launching from low-performance aircraft as a long-burning marker but has been replaced for this purpose by the Mk 58 marine location marker.

The Mk 6 signal consists of a wooden body with a flat, die-cast metal plate affixed to one end to protect it from water impact damage and to maintain it in the correct floating attitude. There are four flame and smoke emission holes in the opposite end, each capped and

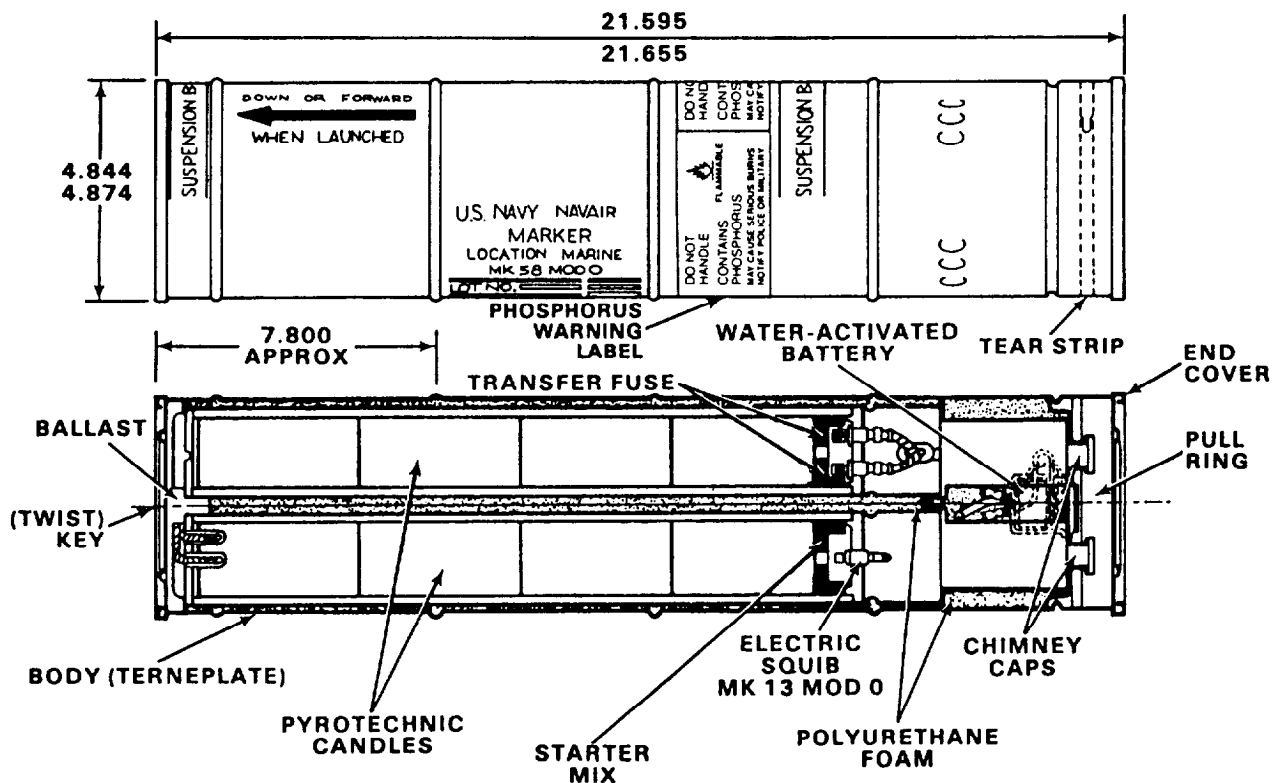

Figure 6-5.—The Mk 58 Mod 0 marine location marker.

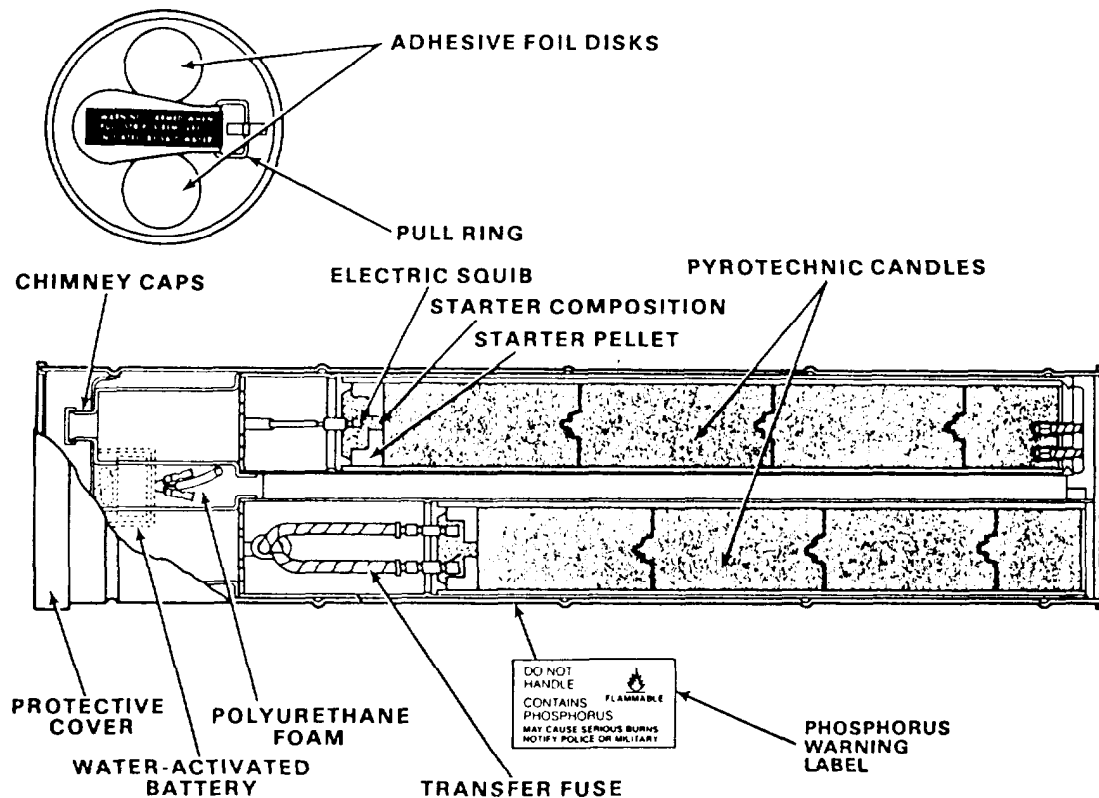

Figure 6-6.—The Mk 58 Mod 1 marine location marker.

sealed with tape. The pull-wire ring, also at the emission end, is also covered with tape.

The Mk 6 signal has a direct-firing ignition system. Ignition results from pulling the pull ring. The pull ring is pulled by hand, and the device is thrown into the water immediately. The pull wire ignites a 90-second delay fuse that ignites the quick match at the top of the first of four candles. The quick match ignites the first candle starting mix, which, in turn, initiates burning of that candle. Expanding gases of combustion force the cap and tape from the emission hole, allowing smoke and flame to be emitted. When the first candle is nearly burned out, a transfer fuse carries the ignition to the quick match of the next candle in series. This process continues until all four candles have burned. The yellow flame and gray-white smoke are produced for at least 40 minutes.

After the tear-strip on the shipping container has been removed, the following rules apply:

1. The tape over the pull ring should not be disturbed until immediately before hand-launching the signal. This tape not only prevents an accidental pull on the pull ring but also protects the igniter assembly from moisture, which might render the signal useless.

WARNING

This signal is initiated by the physical movement of a friction wire through ignition compound. Extreme care must be taken to prevent tension of the pull ring during all handling operations.

2. If this device is prepared for launching and is not launched, the pull ring should be securely retaped into position at the top of the signal without exerting any pulling force on the pull-wire igniter.
3. Under no circumstances should these signals be stowed or restowed with their pull rings exposed or with any wires, strings, or other material of any kind joined to their pull rings.

All safety precautions pertaining to this signal must be observed. In addition, the following specific rules apply:

- Do not remove the tape over the pull ring until immediately before launching.
- The Mk 6 signal should be thrown over the side immediately after pulling the pull ring. This device

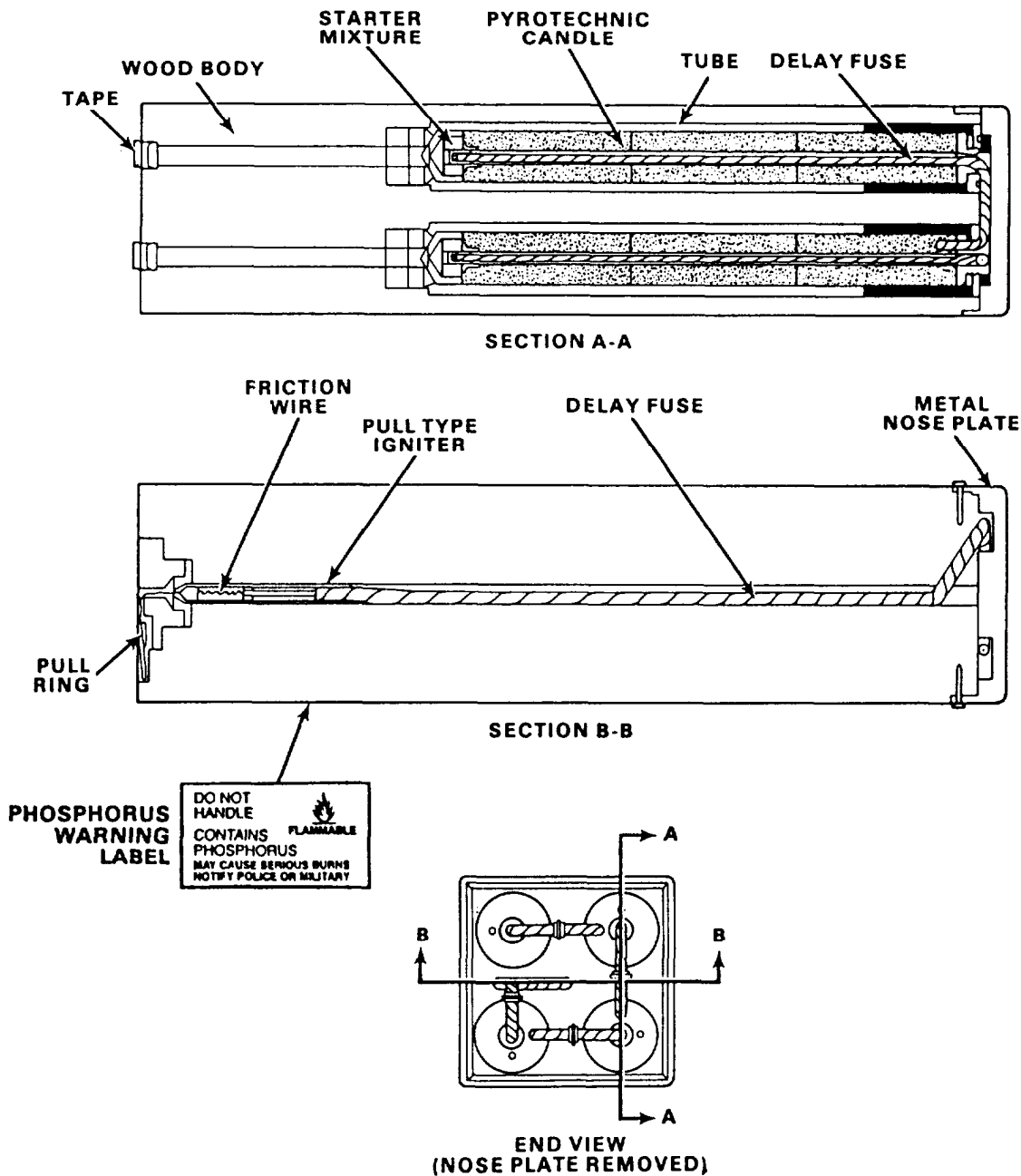

Figure 6-7.—The Mk 6 Mod 3 marine location marker.

contains a maximum 90-second delay element between initiation and candle ignition.

- In all handling, extreme care should be taken to avoid pulling on the pull ring. The slightest movement of the friction igniter may start the ignition train.

The Mk 6 Marine Location Marker is being replaced by the Mk 58. There are, however, remaining serviceable stocks of the Mk 6 available. If you have any of these markers in your inventory, they should be used first.

Man-overboard and navigation drills are good instances where these stocks can be efficiently expended.

MARINE ILLUMINATION AND SMOKE SIGNALS AND PYROTECHNIC PISTOLS

Marine illumination signals are similar in appearance to a standard shotgun cartridge. When fired from the proper pistol or projector, a burning star (somewhat like a star from a roman candle) shoots high into the air. In this section, we describe the marine illumination and

smoke signals and pyrotechnic pistols currently in use. These include the

Mk 2 marine illumination signal,

Mk 5 pyrotechnic pistol,

AN-M37A2 through AN-M39A2 series, double-star illumination signal,

Mk 1 marine illumination signal, and

the AN-M8 pyrotechnic pistol.

MK 2 Marine Illumination Signals

The Mk 2 marine illumination signal is available in three colors: red, green, and white. Each cartridge has a percussion primer and a propelling or expelling charge of 10 grains of black powder, which projects the burning star to a height of about 200 feet. The star charge is a tightly packed cylinder wrapped with a quick match (a fast-burning fuse), which ignites it when fired. The star charge is separated from the expelling charge by a shock-absorbing wad of hard felt. The cartridge is closed by a wad that is so marked that the color of the star can be determined at night by feeling the wad, as shown in figure 6-8.

The red star may be identified by its corrugated closing wad; the green star has a smooth closing wad; and the white has a small conical boss on its closing wad. Each of the three colors may also be identified by the corresponding color of the paper on the cartridge.

The burning time for each of the stars is approximately 6 seconds.

The illumination signals are available in 10-round metal or cardboard containers. The containers are packaged in wooden boxes that hold 40, 45, or 100 containers.

Mk 5 Pyrotechnic Pistol

Marine illumination signals are fired from the Mk 5 pyrotechnic pistol. This pistol is a breech-loaded, double-action, single-shot device, 11 inches long. Metal parts are mounted on a plastic frame. The operating instructions for the Mk 5 pistol are as follows:

1. To load the pistol, depress the latch button below the barrel. At the same time, pull the barrel downward, as in view A of figure 6-9. Insert the signal shell (view B). Push the barrel upward until it latches closed. The pistol is now ready to fire.

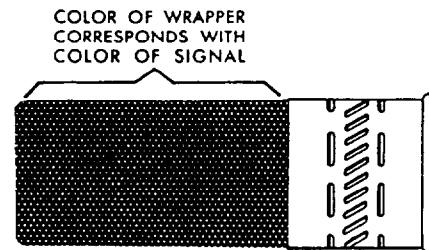
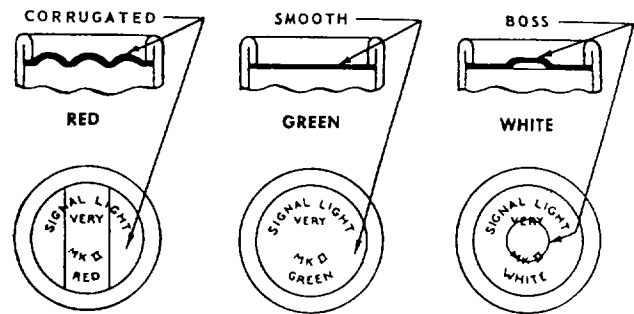

Figure 6-8.—The Mk 2 marine illumination signal.

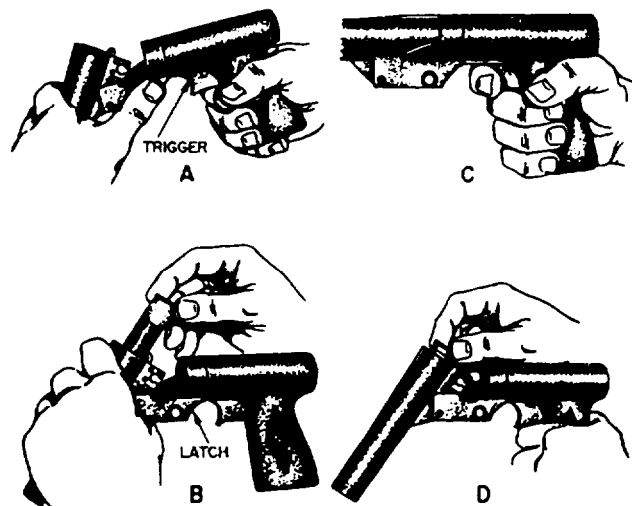

Figure 6-9.—Operation of the Mk 5 pyrotechnic pistol.

2. To fire the pistol, aim it upward at the desired angle, normally 60 degrees, but clear of other ships or personnel. Bull the trigger, as shown in figure 6-9, view C. Keep your elbow slightly bent when firing, to absorb the shock of recoil and to prevent the pistol from knocking itself out of your hand.

3. To extract the expended shell, break the pistol open again (view A), and pull the shell out of the chamber (view D).

WARNING

The pyrotechnic pistol is cocked at all times when the breech is closed; it has no positive safety mechanism. Illumination signals must NOT BE LOADED in the pistol until just before use. Unfired signals must NOT be left in the pistol.

The Mk 5 pistol must be kept in serviceable condition at all times. Clean it thoroughly after each use in accordance with the procedure prescribed on the appropriate 3-M System maintenance requirement card (MRC).

When loading or firing a pyrotechnic pistol, NEVER point it in the direction of other personnel or vessels.

NEVER use the Mk 5 pistol with ammunition other than that authorized for use with it. Conversely, illumination signals should never be fired from shotguns or from projectors other than those authorized.

PYROTECHNIC SAFETY HANDLING AND STORAGE

The following general information is taken directly from *Pyrotechnic, Screening, Marking, and Countermeasure Devices*, NAVSEA SW050-AB-MMA-010, chapter 1.

Pyrotechnic Safety

“All pyrotechnic and screening devices, while designed and tested to be safe under normal conditions, can be subject to accidental ignition because of a wide variety of circumstances. The general rule to follow is: Be constantly aware that pyrotechnics contain chemical components that are intended to burn with intense heat, and act accordingly.”

Pyrotechnic Handling and Storage

All pyrotechnics and smoke-screening devices are designed to withstand normal handling. They should, however, be handled as little as possible to lessen the chances of damage, which might cause accidental ignition or leakage. Many devices contain materials of a dangerous nature and are therefore designed with safety features, which should be maintained in good operating condition. Dents, deformations, or cracks in the outer body may interfere with the proper functioning of these safety features or might cause ignition during

handling or storage. It is therefore imperative that extreme care be taken to prevent damage to containers of pyrotechnics and screening devices, and to the devices themselves.

Effect of Moisture on Pyrotechnics

The proper functioning of pyrotechnic, dye-marking, and screening devices is frequently affected by moisture. Some compositions may become more sensitive and dangerous when exposed to moisture, while others tend to become difficult to ignite and less dependable in operation. Care should be exercised to prevent damage that would interfere with seals because some screening devices produce their smoke by reaction of their chemical contents with moisture in the air. Also, bear in mind that some marine location markers, such as the Mk 58, are saltwater-activated, and should be stored with that in mind. That fact should also be considered in emergency situations where the markers could be inadvertently exposed to fire-fighting water or runoff.

Effect of Temperature on Pyrotechnics

Pyrotechnics and some screening devices may become adversely affected by excessively high or variable temperatures. These devices should never be stored where direct rays of the sun could generate excessively high temperature. Storage should be in dry, well-ventilated places that provide the greatest possible protection from such conditions. All Navy pyrotechnics have been designed to withstand temperatures from -65°F to 160°F and, therefore, will probably be safe from deterioration or damage within that range. However, it is recommended that every reasonable effort be made to maintain storage temperature at not more than 100°F. (Specific ammunition storage temperature requirements are addressed in chapter 2 of this manual.)

Toxic Hazards of Pyrotechnics

Many chemicals used in pyrotechnics, screening equipment, and dye-marking devices are poisonous if taken internally. This also applies to the residue of burned pyrotechnics. From the inhalation standpoint, the products of pyrotechnic devices and smoke generators often present a serious problem. Many of the smokes and fumes given off by pyrotechnics and screening devices are considered non-toxic and only mildly irritating to the eyes and nasal passages when encountered in relatively light concentrations out of

doors. Heavy concentrations in closely confined spaces, however, are dangerous and may be lethal because they reduce the amount of oxygen in the air. Anything more than a brief exposure to the gases of combustion, or to screening smokes, should be avoided or should be protected against through the use of an appropriate breathing apparatus.

ORDNANCE HANDLING SAFETY

LEARNING OBJECTIVES: Recognize safety precautions, practices, and principles applicable for the handling of ordnance. List general ammunition safety precautions. List and define standard commands for gun crews.

The utmost care and prudence must be exercised in supervising the handling, inspecting, preparing, assembling, and transporting of all types of ammunition. People tend to become careless and indifferent when continually engaged in work with explosives and, as long as nothing occurs, are inclined to drift gradually into neglecting the necessary precautions. Nothing but constant vigilance on the part of the all concerned will ensure the steadfast observance of the rules and regulations that experience has taught are necessary.

Safety is everyone's responsibility. Awareness of danger, knowledge of how danger can be avoided, and constant vigilance are the three basic requirements to prevent accidents when working with explosives. If a thorough understanding of the basic ideas behind the precautions is developed, unsafe conditions can be recognized and corrected and further suitable action taken instinctively when the unexpected occurs. Safety precautions pertaining to the handling of and working with explosives may be found in OP 4, *Ammunition Afloat*; OP 1014, *Ordnance Safety Precautions, Their Origin and Necessity*; and OP 3347, *United States Ordnance Safety Precautions*.

Safety precautions, rules, and regulations for handling explosives should be made the subject of frequent review, and the necessity for strict compliance with these precautions should be firmly fixed in the minds and habits of all hands involved in handling explosives so that they will react in an emergency to the instruction previously received.

Note that in the early stages of the use of explosives, experience was gained at a great price—not only in dollars, but in human lives. No relaxation should be tolerated, since this tends to create the impression that the rules are arbitrary.

All personnel assigned to handle ammunition or gunnery equipment should receive a thorough indoctrination from a qualified chief petty officer or petty officer regarding the general safety precautions and procedures to be followed in the course of their duties. This indoctrination is MANDATORY before ANY weapons-handling/firing evolution.

Periodic drills should be conducted to provide realistic training and to identify and/or eliminate any unsafe practices. Inexperienced personnel will constantly be under the direct supervision of skilled and experienced personnel until adequate experience is acquired.

Because of the nature of gunnery and ammunition, safety precautions should be of extreme importance to every Seaman. Compliance with all safety procedures will ensure a safe ammunition transfer.

The following general safety precautions concerning gunnery and ammunition should be of extreme importance to every Seaman:

Ammunition should ALWAYS be handled carefully and ONLY when necessary.

The proper way to handle ammunition is to hold the base of the projectile downward with one hand covering the base, while supporting the top of the round up at a 45° angle and cradling the top, like a baby, in the elbow.

Smoking is prohibited in magazines and any area containing explosives or ammunition, as well as in the vicinity of handling or loading operations involving ammunition.

Naked lights, matches, lighters or other spark-, flame-, or heat-producing devices should NEVER be taken or stowed near magazines or any other area where explosives are present.

Unauthorized personnel should not be permitted in magazines or in the vicinity of handling operations involving explosives or ammunition.

Personnel assigned to gunnery stations during general quarters should ALWAYS know the type of ammunition being handled.

Ammunition handlers should wear appropriate clothing and safety shoes. Ammunition handlers should never wear keys, gloves, rings, watches, or headgear when handling ammunition. Belt buckles should be turned inside or be removed to avoid the possibility of striking a primer on a projectile.

Fire hoses should be laid out and charged before handling weapons as well as gunnery exercises, and repair lockers should be manned and ready as appropriate.

When guns are trained or elevated, an audible warning alarm is sounded from within the gun enclosure. All hands should stand outside the train warning circle.

No ammunition or explosive assembly may be used in any gun system for which it is not designed.

Powder cans and bags must always be in perfect condition.

Care must be taken to avoid obliterating identification marks on ammunition or putting it into incorrectly marked containers.

Smokeless powder must never be exposed to the direct rays of the sun. Powder in bulk, tanks, cartridge cases, ammunition boxes, and other containers must be protected against high temperature.

Smokeless powder, when wet, must be regarded as dangerous for dry storage and must be kept immersed completely in freshwater. It must be turned in at an ammunition depot at the first chance or dumped overboard.

Before any work that may cause either an abnormally high temperature or an intense local heat in a magazine is started, all explosives must be removed to safe storage until normal conditions are restored.

Pyrotechnic material must always be kept by itself in regular pyrotechnic lockers or storage spaces.

Black powder, which is most dangerous, must always be kept by itself. Containers of black powder must never be opened in a magazine or adjacent to other explosives.

Projectiles must not be altered, nor may fuzes or other parts be removed from them on board ship without instructions from higher authority.

A fuzed projectile or a cartridge case, whether in a container or not, if dropped from a height exceeding 5 feet, must be set aside and turned in at an ammunition depot as soon as possible. Such ammunition must be handled with the greatest care.

Service ammunition is never used for drill; only drill ammunition may be used.

Certain fuzes armed by setback may explode accidentally by tapping or jarring. Extreme care must be taken to avoid dropping them.

Care must be taken that nose fuzes are not struck (as by the gun in recoil).

Time fuzes that have been set must be reset on SAFE before storing below.

GUN MOUNTS

LEARNING OBJECTIVES: Define gun mount. Identify the different components of a gun mount.

A gun mount is the supporting structure assembly and operating device for one or several guns. The mounts may be open, or enclosed in a shield. Each mount is assembled as a unit by the manufacturer, then hoisted on board ship and bolted in place.

Modern gun mounts have been effectively developed to meet the threat of all types of targets. They comprise an entire system of gun-supporting parts that enable them to rapidly load, position, and fire their projectiles with such speed and accuracy that they have become the backbone of the U.S. Navy's support forces.

Every gun system includes equipment used for gun positioning, loading, and firing. Loading equipment varies greatly in design from gun to gun, but its purpose remains the same—to load a complete round in the gun chamber for firing. We will describe the various loading systems later in this chapter. The greatest similarities from one gun to the next are found in the positioning and firing components, which we will now describe.

POSITIONING EQUIPMENT

Positioning equipment includes all the machinery used to support and move the gun tube to the desired train (horizontal) and elevation (vertical) angle. Positioning equipment includes the stand, base ring, trunnions, carriage, and slide, (fig. 6-10).

Stand

The stand is a steel ring bolted to the deck; it serves as a foundation and rotating surface for movement in train. The stand contains both the train beatings and the training circle. The training circle is a stationary internal gear that the train drive pinion walks around to move the gun in train.

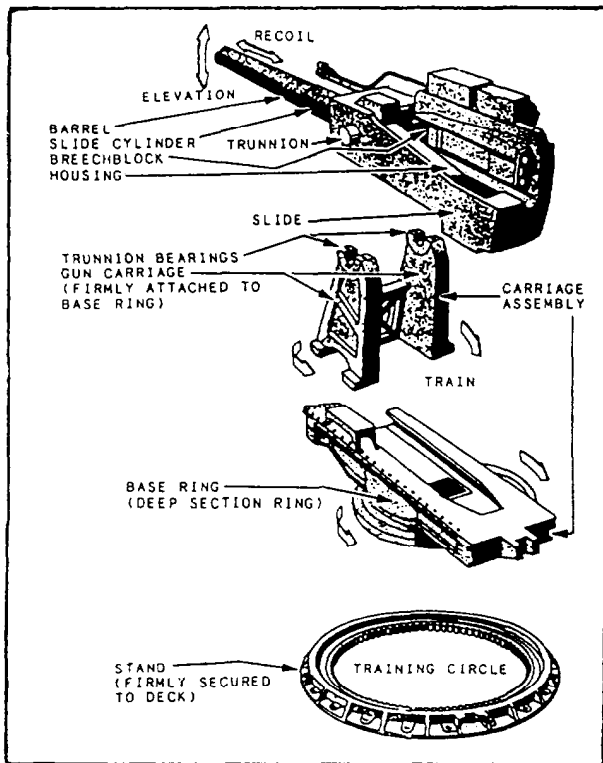

Figure 6-10.—Gun-positioning equipment.

Base Ring

The base ring is also called the lower carriage. It is the rotating platform, supported by the stand, and supports the upper carriage.

Gun Carriage and Trunnion Bearing

The gun carriage is also called the upper carriage. It is a massive pair of brackets that holds the trunnion bearings. The trunnion bearings support the trunnions, which are part of the slide; together they form the elevation pivot point.

Slide

The slide is a rectangular weldment that supports all of the elevating parts of the gun.

FIRING EQUIPMENT

Firing equipment includes all the components necessary to allow the gun to safely fire, absorb the shock of recoil, and reposition for further firing. This includes the housing, breechblock, recoil, counter-recoil systems, firing circuits, and firing cutouts.

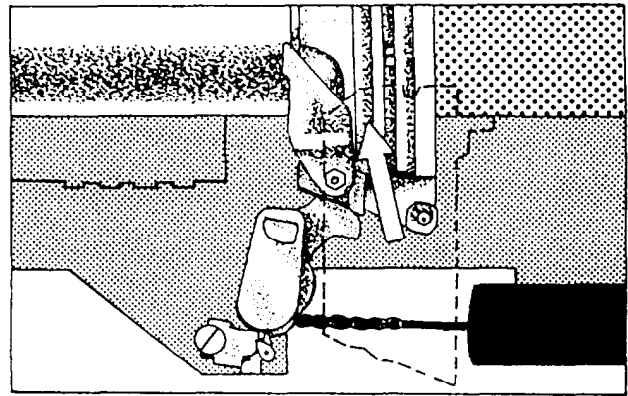

Figure 6-11.—The sliding-wedge breechblock.

Housing

The housing is a large steel casing in which the barrel and breechblock are fitted. The housing moves in recoil inside the slide.

Breechblock

The breechblock seals the breech end of the barrel. The sliding-wedge-type breechblock (fig. 6-11) consists of a machined steel plug that slides in a grooved way in the housing to cover the breech opening. The grooves are slanted so that the breechblock moves forward as it covers the back of the casing, edging it in place. All guns currently use the sliding-wedge-type breechblock.

Recoil System

Normally, a recoil system (fig. 6-12) consists of two stationary pistons attached to the slide, set in a liquid-filled cylinder in the housing. As the housing moves rearward in recoil, the trapped liquid is forced around the piston head through metered orifices, slowing the movement of the housing.

Counterrecoil System

A counterrecoil system consists of a piston (or pistons) set in a pressurized cylinder. As the gun recoils, the piston protrudes further into the cylinder. After the force of recoil is spent, the air pressure, acting against the piston, pushes the housing back into the battery (the full forward position). The piston may be attached to the slide, allowing the cylinder (which is machined into the housing) to slide over it during recoil (fig. 6-13). Later guns use two free-floating pistons set in an air chamber mounted to the inside of the slide (fig. 6-14). Air pressure

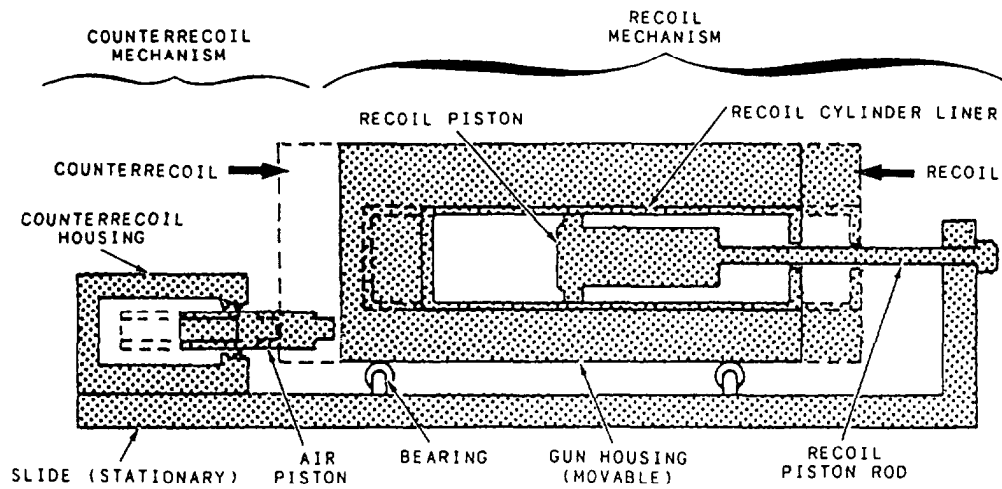

Figure 6-12.—Recoil and counterrecoil system.

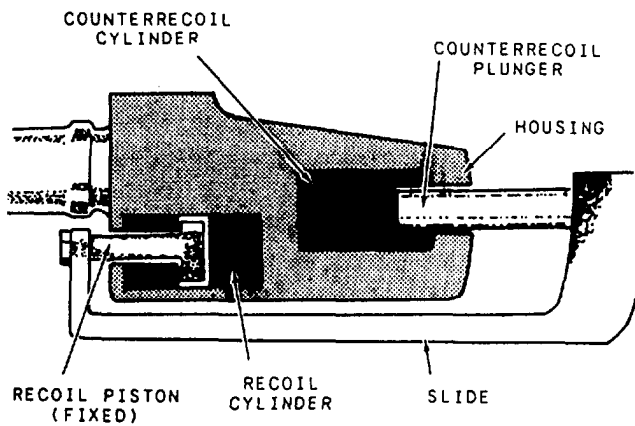

Figure 6-13.—A basic recoil and counterrecoil system.

holds the pistons against the back of the housing, and forces them into the stationary chamber during recoil.

Since the air pressure in the counterrecoil system is the only thing holding the gun in battery, all guns are equipped with a safety link. The safety link physically attaches the housing to the slide to prevent it from moving if system pressure is lost. The safety link is disconnected prior to firing.

Firing Circuits

Basically, a firing circuit supplies firing voltage to the propelling charge primer. This sounds simple, but the application can be quite complicated. For a safe

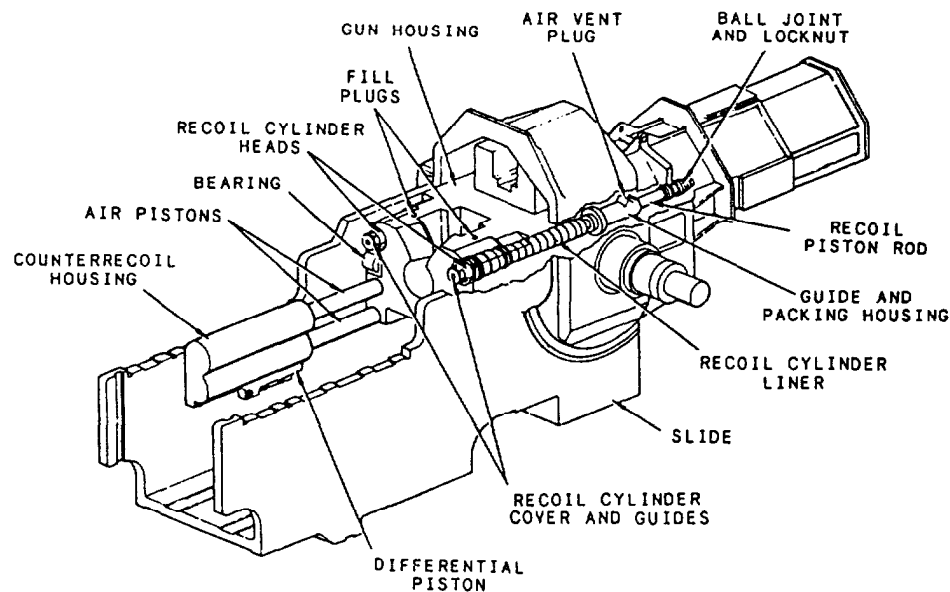

Figure 6-14.—5"/54 Mk 42 recoil and counterrecoil system.

evolution, certain conditions must exist prior to firing. Making sure that the gun is pointed in a safe direction, that all the loading equipment is in the fire position (out of the way of recoiling parts), and that the breechblock is all the way closed are just a few of the obvious things that must be correct before firing. A typical electronic firing circuit includes inputs that monitor these and many other conditions, allowing firing voltage to pass only after all safety conditions have been satisfied.

Firing Cutouts

A firing cutout mechanism interrupts firing when the gun is pointed at or near the ship's permanent structure. A firing cutout is a mechanical device that monitors gun position.

The components we have just described are common to all guns. We will now discuss the individual gun systems in the fleet today, paying particular attention to the loading system in each one.

GUN SYSTEMS

LEARNING OBJECTIVES: List and explain the different gun mounts used aboard ship. Explain crew position and responsibilities and loading sequence when operating gun mounts.

As you read this section and study the illustrations, note the different configurations of machinery designed to accomplish the same task from one gun to the next. When we are speaking of gun equipment, all directional nomenclature (left, right, front, back) is relative to the muzzle of the gun (the end of the barrel from which the projectile exits when fired); the muzzle is to the front as you stand inside the gunhouse.

5"/54 MK 42 GUN

In the 1950s as potential targets became faster and more sophisticated, a gun with more range and a faster rate of fire was needed. The 5"/54 Mk 42 was developed to effectively engage these targets as well as shore targets. Several versions of the Mk 42 gun have seen service since then. In the fleet today, you will find only the Mod 9 and the Mod 10; all others have been retired. The two versions are identical in many respects. The differences will be pointed out at the end of this section.

The 5"/54 Mk 42 is an automatic, dual-purpose gun mount. It can be controlled either remotely from a fire control system, usually the Mk 68 GFCS, or locally from the mount at the One Man Control (OMC) station.

The normal mode of operation is the remote mode. The mount fires an average 70-pound projectile up to 26,000 yards with a 48,000-foot ceiling. The gun, with its automatic loading system, has a rate of fire of 34 rounds per minute.

As you will see, the loading system is actually two almost separate systems, left and right. The ammunition carrier and the hydraulic power drive units are the only components shared by both sides. The advantage of having separate systems is readily apparent. In the event of a casualty, you can isolate the affected side and continue to fire at 17 rounds per minute from the other side.

We will now describe the major components of the mount as we walk through a loading cycle.

Figure 6-15 illustrates the major components of the 5"/54 Mk 42 gun. The gun is operated by the mount captain from the EP2 panel. Electrical power is supplied to the gun through the EP1 panel. Both the EP1 and EP2 panels are located in the compartment directly under the mount, along with the lower hoist power drive, ammunition carrier, and upper hoists. This compartment is commonly called the carrier room. Inside the gun mount, there are two manned positions: the gun captain and the OMC operator. The gun captain has the responsibility of monitoring the operation of the gun and relaying bore reports (whether or not the gun bore is clear) after each round or salvo is fired. The OMC operator functions as a check sight observer during normal firing. As check sight observer, he uses the telescopic sight to ensure that the gun is trained on the intended target. He then reports *CHECK SIGHT ON TARGET*. The loader drums, located in the projectile magazine, are served by the magazine crew. The magazine crew is made up of Seamen from various divisions of the ship. You may be assigned to this station. Here, you will remove propelling charges and projectiles from their storage bins and load them into the loader drums at the command of the mount captain. Some individuals from the magazine crew also serve as members of the *hot gun* clearing team. The responsibilities of this team will be described later in this chapter.

When a remote order is received, the mount captain gives control of gun train, elevation, and firing circuit to the fire control system. When ordered to fire, the mount captain initiates the loading cycle by pressing the RAM ONCE or the RAM CONTINUOUS button on the EP2 panel. RAM ONCE allows one round to be loaded and fired. RAM CONTINUOUS allows the gun to continue firing until it is empty or ordered to stop by

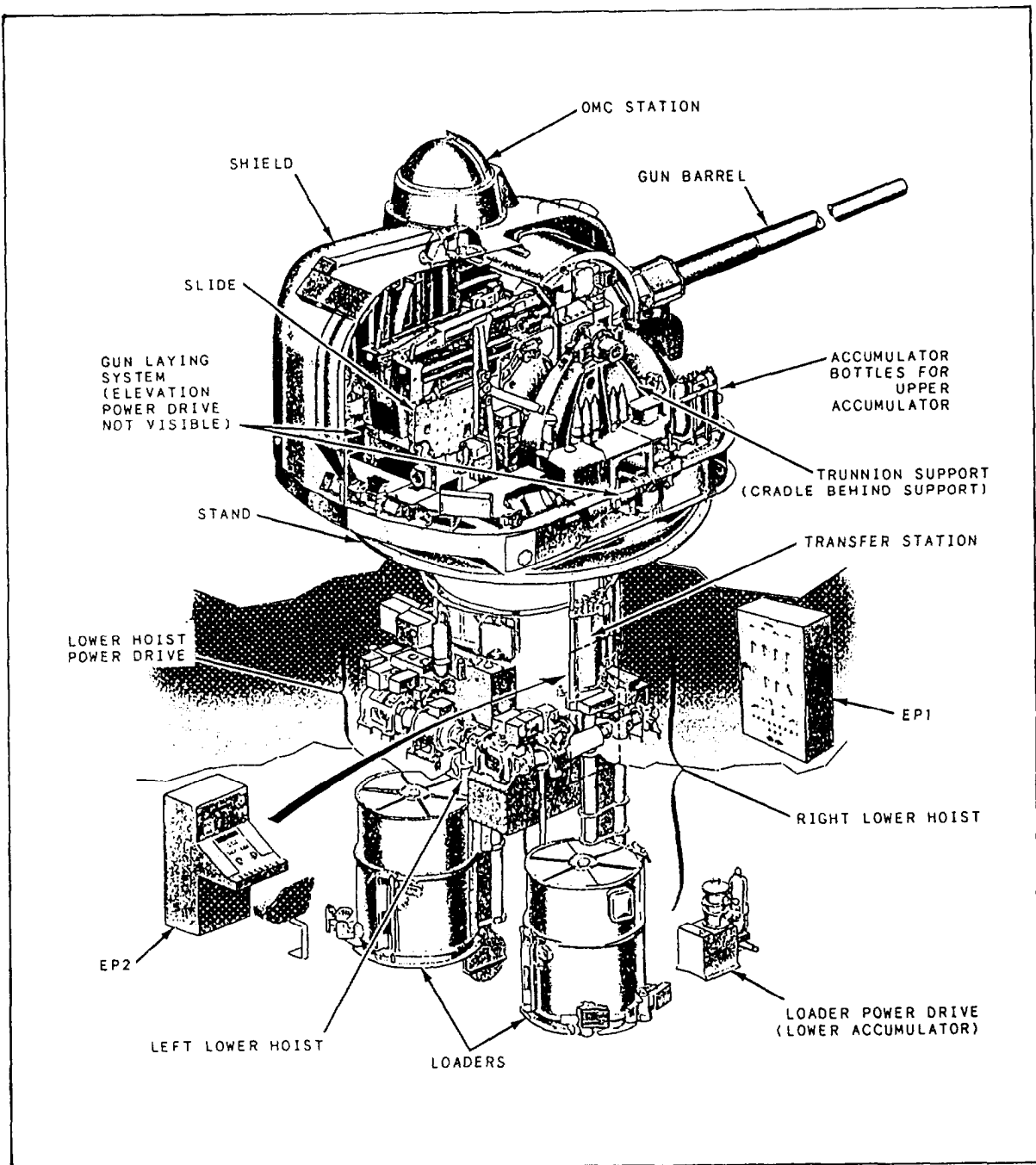

Figure 6-15.—Major components of the 5"/54 Mk 42 (Mod 10 shown).

the mount captain, who presses the OFF button. In both instances, the rounds are fired using firing voltage supplied from the fire control system. When firing is controlled from the OMC station, the operator supplies all the inputs normally received from the fire control system. The operator positions the mount with the OMC unit, while aiming with the telescopic sight, then fires the gun using his/her own firing key. Note that the mount

captain has to physically give control of the mount to the intended operator.

5"/54 MK 45 GUN

The 5"/54 Mk 45 gun, developed in the early 1970s, is the newest of the 5" guns in the fleet today. It is found aboard the DD-963, DDG-51, LHA-1, and CG-47 class

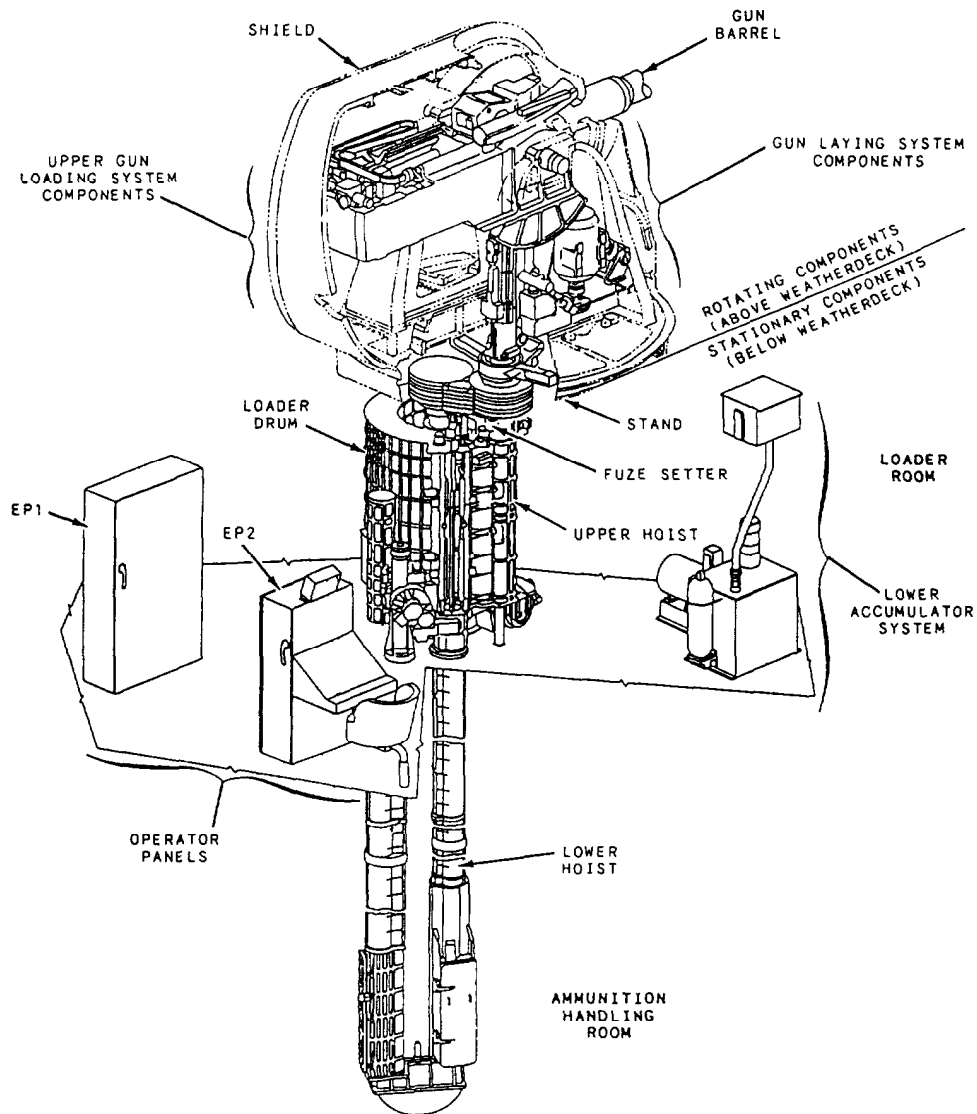

Figure 6-16.—The 5"/54 Mk 45 Mod 0, general arrangement.

ships. The Mk 45 (fig. 6-16) is a fully automatic, dual-purpose, lightweight gun mount capable of firing the full range of 5"/54 projectiles, including rocket-assisted projectiles (RAPs), at a rate of 17 to 20 rounds per minute. During normal operation the loading system (fig. 6-17), like the Mk 42, is operated locally by the mount captain; the gun laying, fuze setting, and firing orders are generated by the FCS. The gun may be positioned locally from the EP2 panel for maintenance only.

The only manned positions on the Mk 45 gun during normal operations are the mount captain, who operates the gun from the EP2 panel, and the loader room crew. The gun mount itself, unlike the Mk 42, is unmanned. There is no local firing position, as with the Mk 42

OMC. The mount power distribution panel, EP1, is also the mount captain's responsibility.

The loader drum holds a total of 20 complete rounds of ammunition. Before an operation, the loader crew will load the drum, through the lower hoist, with 20 rounds of one type of ammunition. If during the operation another type of round is desired, the mount captain, using local controls, can allow the system to operate under alternate loading. This mode allows the loaders to hand-feed the different types of ammunition into the loading system, which automatically transfers only these rounds to the breech for firing. Depending upon the tactical situation, the loader crew may be required to load several different types of ammunition in a short time. The loader crew must, therefore, be able

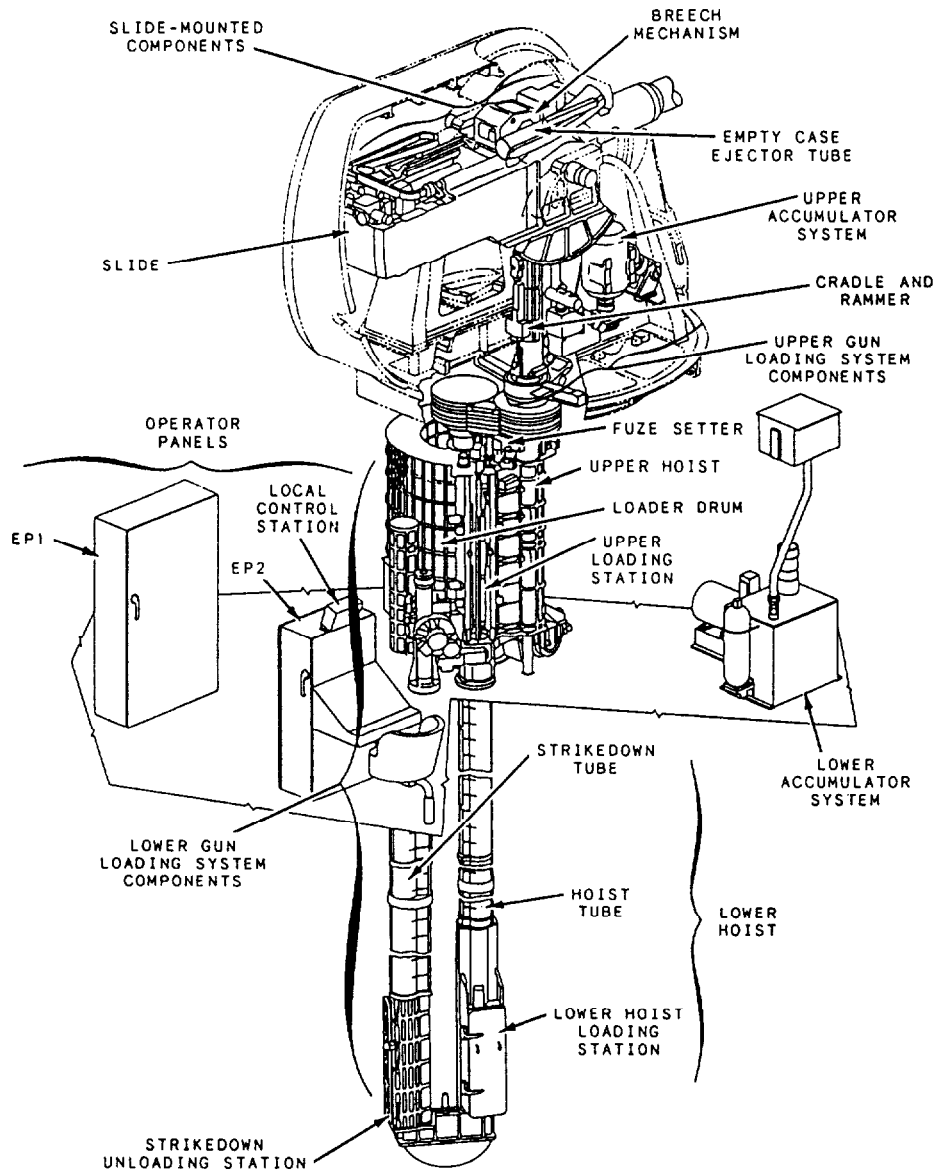

Figure 6-17.—The 5"/54 Mk 45 gun loading system, major components.

to quickly and accurately identify the various ammunition types.

76-MM MK 75 GUN

The Mk 75 gun (fig. 6-18) is a fully automated, remotely controlled gun mount that stows, aims, and fires 76-mm 62-caliber ammunition. The 76-mm system, along with the Mk 92 GFCS, is currently aboard FFG-7- and PHM-class ships. The design of the gun mount makes extensive use of lightweight corrosion-resistant alloys and modern engineering techniques. The result is a lightweight, compact, fast-firing, versatile weapon. It is primarily a defensive weapon, used to destroy antiship cruise missiles.

However, it can also be used effectively against surface and shore targets. The gun has a variable rate of fire of up to 80 rounds per minute with a range of up to 16,459 meters and a maximum altitude of 11,519 meters. The most notable innovation featured on this system is the automatic barrel cooling system. This cooling system allows sustained operation at high rates of fire without excessive barrel wear or the danger of a cookoff if a misfire occurs.

The Mk 75 gun fires a somewhat limited variety of ammunition types. The types of ammunition currently available include point detonating (PD), infrared (IR), radio frequency (RF), and blind-loaded and plugged (BL&P).

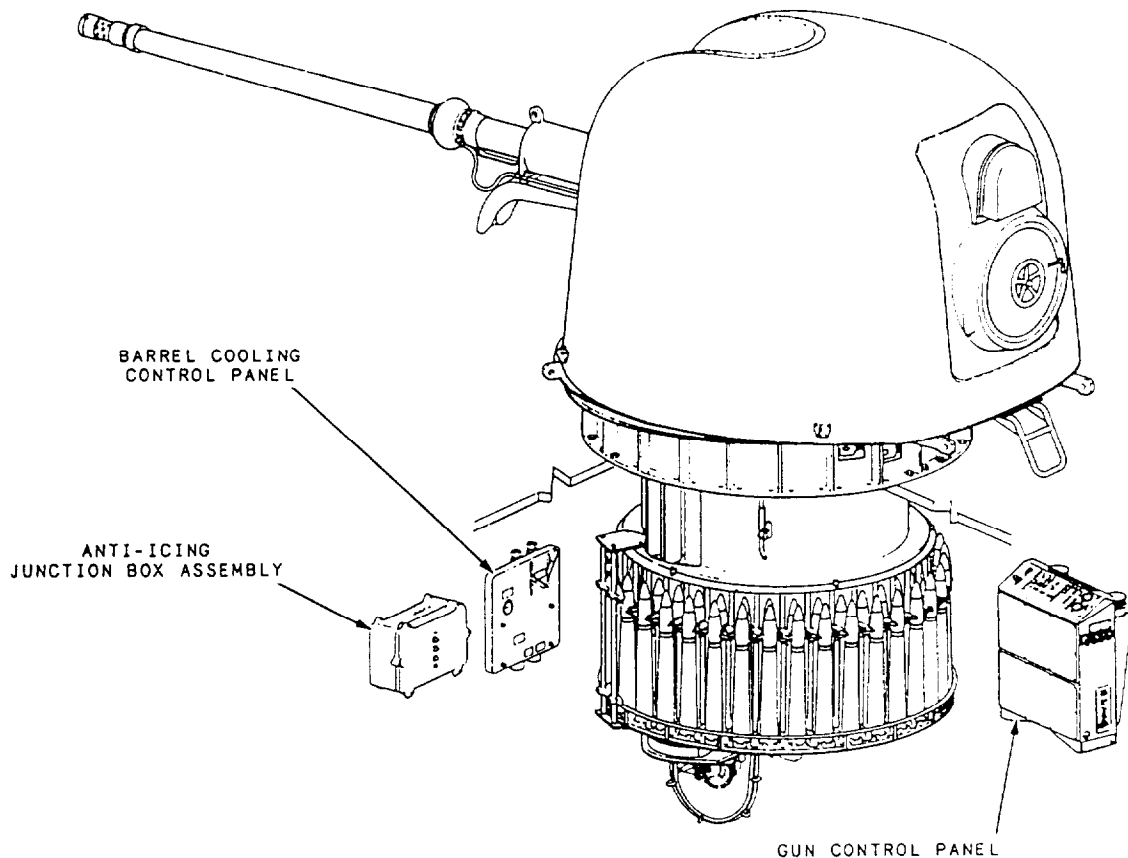

Figure 6-18.—The Mk 75 gun system, general configuration.

The gun mount crew consists of the mount captain, two loaders, and the safety observer.

The mount captain is stationed in the ammunition-handling room at the gun control panel (GCP). It is the mount captain's responsibility to set the gun up for the desired mode of operation, then monitor it, in case of a malfunction. In case of a malfunction or misfire, the mount captain supervises and directs the corrective action.

The two loaders are stationed in the ammunition-handling room during loading and unloading operations. Their primary duties are to load and unload the gun, clear misfires, and assist in corrective maintenance. Although the actual loaders may be Gunner's Mates (GMGs), you may be stationed in the handling room to assist in breaking out the ammunition for loading.

The safety observer is stationed topside, near the gun. It is the responsibility of the safety observer to monitor the gun and the area around the gun for any unsafe condition. The safety observer is in direct contact with the mount captain.

HOT-GUN CREW

LEARNING OBJECTIVE: Define the duties of a hot-gun crew.

As is true of all mechanical devices, guns, too, are susceptible to malfunctions. In the case of a gun system, however, you are also dealing with large quantities of propellant and high explosives. When a gun misfires, either the casualty must be corrected quickly or the round removed from the gun chamber and disposed of over the side. A *hot gun* is a gun that has fired a sufficient number of rounds in a defined period of time and reaches a temperature that could *cook off* the round in the chamber. And should the gun misfire while in the hot-gun condition, clearing the gun quickly becomes a very high priority. An inbore explosion is a catastrophic event and should be avoided at all cost.

As a member of the hot-gun clearing crew, you will assist the Gunner's Mates in clearing the misfired round from the gun. They will actually remove the round from

the chamber and pass it out to a member of the team for disposal over the side. While this is occurring, team members may be called upon to set up fire hoses with special attachments for internal and external gun cooling. External cooling will normally begin immediately after a misfire. Internal cooling can only be started after the propelling charge has been removed. These procedures are directed by the mount captain.

External cooling directs cooling water to the outside of the gun barrel through a standard fire nozzle configured to be attached to the barrel. Internal cooling uses a special applicator, which is inserted into the gun barrel, to directly cool the inside of the barrel and projectile.

Another similar task for magazine crew members is to assist in the disposal of leaking white phosphorous projectiles. Both tasks require regular training and practice. Since the procedure for the disposal of leaking white phosphorous projectiles is subjected to regular revision, this procedure will not be discussed here.

All hands aboard ship should become familiar with certain standard gunnery commands. All gun and magazine crew members, however, need to become especially familiar with these commands. Like the gun crew, the magazine crew must operate as a smooth, safe machine.

NOW MAN ALL GUNNERY STATIONS is the command used to direct gun and magazine crew personnel to “Lay to assigned stations; get in battle dress; and make preparations to service gun(s) for action.”

Other standard gunnery commands, along with the proper interpretation, are as follows:

LOAD—Ammunition handlers in magazine crews fill projectile hoists or mechanisms with prescribed ammunition.

COMMENCE FIRING—This is a command from gunfire control indicating that firing of designated gun(s) is authorized.

CHECK FIRE—A gong or siren is sounded and all guns immediately stop firing.

RESUME FIRING—Gunfire control orders firing to start again. This command is given AFTER a CHECK FIRE.

CEASE FIRE—All guns stop firing immediately upon receipt of this command. A gong or siren is sounded. Gun captains automatically report to gunfire control on the condition of the gun bore, the number of rounds fired and the number of casualties, if any. An example would be “Mount 51 bore clear, 10 rounds expended, no apparent casualties.”

SILENCE—Any member of the gun crew or magazine crew who observes a serious casualty or dangerous condition requiring immediate attention for safety reasons will sound off “SILENCE.”

All personnel hearing this command freeze in position until further orders or CARRY ON is heard. The senior person at the scene will take charge and remedy the unsafe condition.

SUMMARY

In this chapter, we discussed today's naval gun systems and the type of ammunition used by each. This basic knowledge should enable you to perform as an integral member of a gun or magazine crew. This manual should help you in your at-sea experiences and, together with practical experience gained over a period of time, provide the necessary guidance you will need to become a top-notch Seaman. Your time at sea should be both challenging and rewarding.

APPENDIX I

GLOSSARY

Upon entering a new occupation, a person usually is confronted with the need to learn the vocabulary of the trade in order to understand, and be understood by, his or her co-workers.

Today, with the advent of highly sophisticated and detailed programs and procedures at sea, the understanding and proper usage of nautical terminology has never been more important. Safety and professionalism require that an entirely new vocabulary be learned.

Under certain circumstances, a single word or phrase often makes a lot of explanatory details unnecessary.

A misinterpreted order can easily cause confusion, loss of equipment, or even loss of life. To prevent this danger, you must learn to say exactly what you mean.

This glossary is provided for your convenience. It is not intended to be all-inclusive but does contain many orders and terms every Seaman should know.

AA-Abbreviation for anti-aircraft.

ABACA-The wild banana plant of the Philippines.

Manila line is made from its fibers. Manila line is no longer used for highline transfer.

ABAFT-To the rear of.

ABANDON SHIP-To leave the ship in an emergency such as sinking.

ABEAM-Bearing 90° or 270° relative from own ship's heading or course.

ABOARD-In a ship or on a naval station. **CLOSE ABOARD** means near a ship, usually within 600 meters.

ABREAST-Beside one another; side by side in a line.

ACCOMMODATION LADDER-A portable stairway hung over the side of a ship for ascending from or descending to small boats.

ADRIFT-Loose from mooring; scattered about; not in proper stowage.

AFLOAT-Floating upon the water.

AFT-Pertaining to the stern, or toward the stern, of a ship or aircraft.

AFTERNOON WATCH-The watch from noon to 4 pm (1200-1600).

AGROUND-When any part of a ship is resting on or is in contact with bottom.

AHOY-The customary nautical hail to a boat or ship. Supposedly once the dreaded war cry of the Vikings.

AIDS TO NAVIGATION-Bells, markers, lights, buoys, horns, radio stations, or any similar device to assist navigators.

ALL HANDS-The entire ship's company.

ALOFT-Above the decks, on the mast, or in the rigging.

ALONGSIDE-At the side of a ship, pier, or dock; in a parallel position.

AMIDSHIPS-In or toward the part of a ship midway between the bow and the stem.

AMMO-Slang for ammunition.

ANCHOR-(1) A device used to hold a ship or boat fast to the bottom. (2) The act of making fast. (3) The act of securing or fixing the lower end of a guy or stay.

ANCHOR AT SHORT STAY-Anchor chain at minimum length with anchor still down.

ANCHOR BALL-A black, circular shape hoisted to indicate that the ship is anchored.

ANCHOR BUOY-A small float secured to the anchor by a light line to mark the position of the anchor.

ANCHOR CHAIN-A heavy stud-linked chain used for anchoring ships.

ANCHOR DETAIL-Personnel on the forecastle assigned to handle ground tackle.

ANCHOR IN SIGHT-A report made by the anchor detail on the forecastle to the bridge when the anchor is sighted. Followed by "CLEAR ANCHOR" or "FOUL ANCHOR," depending on whether the anchor is clear for hoisting to the housed position.

ANCHOR LIGHTS-Lights required by *Rules of the Road* indicating that a vessel is anchored.

ANCHOR WATCH-A detail of Seamen who stand watch on deck. Those not on watch sleep in assigned places and are on call throughout the night for such duties as deemed necessary by the officer of the deck.

ANCHORAGE-A place assigned for anchoring vessels.

ANCHORS AWEIGH-An expression used to report that an anchor has just been lifted clear of the water. The ship bears the weight of the anchor and is considered to be underway.

ARMAMENT-The weapons or weapons systems of a ship.

ARMOR-PIERCING (AP)-Ammunition especially designed to penetrate armor.

ARMORY-A compartment aboard ship where small arms and light machine guns are serviced and stowed.

ASSAULT CRAFT-A landing craft used in amphibious operations.

ASTERN-Toward the back or after end of a ship.

AVAST-An order to stop or cease, as "AVAST HEAVING."

AYE, AYE-A seamanlike reply to an order or instruction signifying that the order is heard and understood.

BACK-To reverse engines so that a ship may be stopped or made to go astern, that is, "BACK DOWN."

BAIL-(1) To dip water out of a boat. (2) A V-shaped support at midpoint, which, in turn, provides support at each end (as the bail of a gangway). (3) The handle of a bucket.

BALLAST-Weight added to a ship to ensure stability.

BARGE-(1) A large, scow-type craft usually propelled by towing or pushing. (2) A motorboat assigned for the personal use of a flag officer.

BATTEN DOWN-To cover and fasten down. To make a hatch watertight for heavy seas.

BATTLE DRESS-The manner of wearing a uniform for general quarters; that is, bloused trousers, shirt buttoned up completely, wearing appropriate head gear, and belt buckles reversed or removed.

BATTLE LANTERN-A battery-powered electric lantern for emergency use.

BATTLE LIGHTS-Dim red lights below decks for required illumination during night and "darken ship" periods.

BEAM-The greatest width of a ship.

BEARING-The direction of an object from the observer, expressed in three figures from 000\$ clockwise through 360\$. True bearing is measured from true north. Magnetic bearing is measured from the magnetic north. Relative bearing is measured from the bow of a ship or aircraft.

BEARING CIRCLE-A ring fitted over a compass bowl or repeater with which bearings can be taken by sighting through vanes.

BELAY-(1) To make fast or secure a line. (2) To cancel an order. (3) To cease.

BERTH-(1) An anchorage or mooring space assigned to a ship. (2) A sleeping place assigned to a crew member on board ship.

BIGHT-A loop of line or chain.

BILGE-The inside bottom of a ship or boat.

BILL-Assignments by name for administrative, training, or emergency duties, that is, rescue and assistance (R&A) bill.

BITTER END-The free end of a length of line, wire, chain, or cable.

BITTS-A pair of heavy metal posts, fastened in a vertical position on deck to which mooring lines are secured.

BLOCK-A device made of a pulley encased in a shell, over which a line can run freely.

- BOAT BOOM**-A spar swung out from a ship's side from which boats can be hauled out or made fast. Permits boats to ride safely alongside a ship while at anchor.
- BOAT CALL**-A flag signal used to communicate with a boat.
- BOAT CHOCK**-A deck fitting supporting a boat end that is resting on deck
- BOAT DECK**-A partial deck above the main deck, usually fitted with boat davits or cranes.
- BOAT FALLS**-The lines used in hoisting or lowering a boat.
- BOAT GONG**-A signal used to indicate departure of officers' boats and the arrival or departure of various officers.
- BOAT HOOK**-A wooden staff with combined hook, usually made of brass, to reduce danger of sparks; used to engage rings, lines, or buoys from the deck of a small craft, or to push away from any object on the water's surface.
- BOAT SKIDS**-Deck fittings designed to hold and support a boat.
- BOATSWAIN**-A warrant officer whose major duties are related to deck and boat seamanship.
- BOATSWAIN'S CALL**-A tune played on a boatswain's pipe announcing or calling for a standard evolution such as meals for the crew, lower away, and so forth.
- BOATSWAIN'S CHAIR**-A seat sent aloft or over the side to facilitate repairs or painting.
- BOATSWAIN'S LOCKER**-A compartment where deck gear is stowed.
- BOLLARD**-A steel or iron post on a dock, pier, or wharf, used in securing a ship's lines.
- BOLO**-A nylon line with a lead weight or monkey fist, thrown from ship to ship or from ship to pier during underway replenishment evolutions.
- BOOT**-A newly enlisted marine or sailor. Slang for recruit.
- BOURRELET**-The forward bearing surface of a Navy gun projectile, machined in a band around its body to provide support for the projectile in the bore.
- BOW**-The forward end of a ship or boat.
- BOW HOOK**-A member of a boat crew who mans the forward line or boat hook
- BOW NUMBER**-The hull number of a ship, painted on the bow. This number gives positive identification.
- BREAK**-To unfurl a flag quickly. In ship construction, a change in the contour of a ship's main deck
- BREAK OUT**-To take out of stock or storage and prepare for use.
- BREAKDOWN LIGHTS**-Two vertical red lights on the highest mast of the ship that denote "NOT UNDER COMMAND."
- BREAST LINE**-A mooring line from ship to pier, perpendicular to the ship's centerline.
- BREECH**-The opposite end from the muzzle of a gun where rounds are inserted for firing.
- BREECHBLOCK**-A device that closes the chamber of a large gun after loading. In small arms, called a bolt.
- BRIDGE**-A ship's structure, topside and usually forward, which contains control and visual communication stations. The underway conning station on most ships, except in submarines.
- BRIGHTWORK**-Unpainted and uncovered metal, generally brass or chrome, that is kept bright by polishing.
- BULKHEAD**-Walls or partitions within a ship, generally referring to those with structural functions such as strength and water tightness.
- BUOY**-A floating object, anchored to the bottom, indicating a position on the water, to mark an obstruction or shallow area, or to provide a mooring for a ship.
- CAMEL**-A float used as a fender between two ships or a ship and a pier.
- CAPSTAN**-The rotating mechanism that raises the anchor or other heavy weight.
- CAPTAIN'S MAST**-A hearing held by the commanding officer whereby the commanding officer awards punishment, listens to requests, or commends personnel for meritorious achievements or special service.
- CARGO NET**-A square net of line used to transfer case goods and small cargo.
- CARGO PORT**-A large opening in the side of a vessel for removing or loading cargo.

- CARRY ON**-An order to resume previous activity after an interruption; usually after personnel have come to attention.
- CAST OFF**-An order given to let go, or throw off, mooring lines from a bollard or cleat.
- CHAFING GEAR**-Canvas, line, or other material placed around rigging and mooring lines to prevent wear.
- CHAIN LOCKER**-Compartment for stowage of anchor cable.
- CHAIN OF COMMAND**-(1) The succession from superior to subordinate through which command is exercised (2) The succession from subordinate to superior through which requests should go.
- CHAIN PIPE**-The tube in the deck through which the anchor cable leads to the chain locker.
- CHARHOUSE**-The compartment on or near the bridge used by the navigator for the handling and stowage of navigational equipment.
- CHECK**-To keep a strain on a line but to ease out only enough to prevent its parting.
- CHOCK**-A metal fitting that serves as a lead for lines to a pier or to other ships. It may be open or closed.
- CHRONOMETER**-An accurate clock used in navigation.
- CHURCH PENNANT**-A blue and white pennant flown above the ensign during church services on board a Navy ship.
- CLAMP DOWN**-To sprinkle the deck with water and swab it down. Distinguished from swabbing, which uses a wet mop frequently doused and wrung out in buckets of water.
- CLEAT**-A metal fitting with two projecting arms to which lines are belayed.
- CO**-Abbreviation for commanding officer.
- COAMING**-A name given to any raised framework around deck or bulkhead openings or cockpits of open boats to prevent entry of water.
- COIL**- To lay down a line in circular turns piled loosely on top of one another.
- COLORS**-(1) The American flag. (2) The ceremony of raising the flag at 0800 and lowering it at sunset aboard a ship not underway, or at a shore station.
- COMPARTMENT**-An interior shipboard space enclosed by bulkheads, in which personnel work and live.
- COMPARTMENT CHECK-OFF LIST**-A list of fittings, their location, and function in a compartment for a specific purpose.
- COXCOMBING**-Fancy knot work consisting of coils of line worked around a tiller handle, stanchion, and so forth.
- COXSWAIN**-Enlisted person in charge of a small boat.
- DAMAGE CONTROL**-Measures necessary to preserve shipboard watertight integrity, stability, and offensive power; to control list and trim; to limit the spread of, and provide adequate protection from, fire; to limit the spread of, remove contamination by, and provide adequate protection from, toxic agents, and to care for wounded personnel.
- DAMAGE CONTROL CENTRAL/CENTRAL CONTROL STATION (DCC) (CCS)**- A compartment located in a protected location from which measures for control of damage and preservation of the ship's fighting ability are directed
- DARK ADAPTATION**-Eyes become accustomed to darkness in order to have good night vision.
- DARKEN SHIP**-Blocking out all lights visible from outside the ship.
- DAVIT(S)**-A fixed or movable crane that projects over the side of a ship. Used in pairs to handle boats. Some of the tragic losses of life during nautical disasters were traceable to lifeboat davits that could not be operated properly under existing circumstances (improper maintenance, overloading, panicky passengers, and inexperienced crews).
- DEAD AHEAD**-Directly ahead; bearing 000° relative.
- DEAD ASTERN** Directly aft, bearing 180° relative.
- DEAD IN THE WATER**-Said of a vessel that has stopped and has no way on, but is not moored or anchored
- DEAD RECKONING (DR)**-A method of navigation using direction and amount of progress from the last determined position to a near dead reckoning or DR.
- DECK**-A floor in a ship. The uppermost complete deck is the main deck. Decks often derive their name from construction.

- DECONTAMINATE** -To free from harmful residue of chemical or nuclear attack.
- DETAIL**-To assign personnel to a particular duty within their duty station.
- DIP**-To lower the national ensign about one-third of the way, then raising it, as a salute to a passing warship.
- DIP THE EYE**-Passing the eye of a line through that of another line and then around a bollard.
- DIVISION**-The basic unit into which personnel are organized aboard ship, in aircraft squadrons, or at shore activities.
- DOG WATCH**-One of two 2-hour watches; 1600-1800 or 1800-2000.
- DOUBLE UP**-To double mooring lines for added strength.
- DOWNHAUL**-Line or wire that pulls an object downward.
- DOWSE**-(1) To put out. (2) To lower a sail quickly. (3) Wet down or immerse in water.
- DRAFT**-The depth of a ship beneath the waterline, measured vertically to the keel.
- DRAFT MARKS**-Numeral figures on either side of the stem and stern, used to indicate the amount of the ship's draft.
- DRILL**-A training exercise in which actual operation is simulated.
- DRY RUN**-A rehearsal of any kind.
- DRYDOCK**-A watertight basin that allows examination and work on the bottom of a ship.
- DUNNAGE**-Any material used to separate (or insulate) layers of cargo, create space for cargo ventilation, or insulate cargo against chafing.
- EASE**-To do something slowly, as move slowly away from the pier or ease the strain on a line.
- EASE HER (the rudder)**-Reduce the amount of rudder the ship is carrying. Generally, an order given as the ship approaches the desired course.
- EIGHT O'CLOCK REPORTS**-Reports received shortly before 2000 by the executive officer from the department heads. In turn, they make eight o'clock reports to the commanding officer.
- EMERGENCY DRILL**-A rehearsal of the action to be taken by ship's crew in an emergency, such as fire or flooding.
- ENGINE ORDER TELEGRAPH**-A device on the ship's bridge to give engine orders to the engine room.
- EXECUTIVE OFFICER**-The officer second in command; XO.
- EXTRA DUTY**-Additional work assigned by the CO as authorized by the Uniform Code of Military Justice.
- EYES OF THE SHIP**-The most forward part of the forecastle on the weather deck
- FAIRLEAD**-A fitting, such as a block, providing a passage free of friction for a line or cable.
- FANTAIL**-The after-most deck area topside in a ship.
- FATHOM**-A measure of length equal to 6 feet, used especially for measuring the depth of water.
- FENDER**-A device of canvas, wood, rubber or plastic slung over the side of a ship to absorb the shock of contact between the ship and the pier or between ships.
- FID**-A sharply pointed, round wood or metal tool used in separating the strands of a line for splicing.
- FIELD DAY**-A particular day devoted to general cleaning, usually in preparation for inspection.
- FIRST CALL**-A routine call sounded as a warning signal 5 minutes before morning and evening colors and other ceremonies.
- FIRST LIEUTENANT**-The officer aboard ship responsible for the upkeep and maintenance of the ship, its boats, ground tackle, and deck seamanship in general.
- FIRST WATCH**-The 2000-2400 watch.
- FLARE**-A pyrotechnic device used to attract attention or illuminate an area.
- FLUKES**-The broad arms or palms of an anchor.
- FORECASTLE**-The forward section of the weather deck.
- FOXTAIL**-A short-handled brush.
- FRAMES**-Aftwartships strengthening members of a ship's hull, numbered from bow aft, and used as reference points to locate fittings, compartments, etc.
- FRAPPING LINES**-Lines passed around the forward and aft boat falls to steady the boat when hoisting or lowering.

- FREEBOARD**-The vertical distance from the weather deck to the waterline.
- GAFF**-A small spar on the after mast from which the national ensign is flown while underway.
- GENERAL QUARTERS**-The condition of maximum readiness for combat with the crew at battle stations.
- GIG**-A ship's boat designated for use by the commanding officer.
- GRAPNEL**-A small four-armed anchor used to recover objects in the water.
- GRIPE**-Device for securing a boat at its davits or in a cradle.
- GROUND TACKLE**-The collective term identifying the equipment used in anchoring or mooring with anchors.
- HALYARD**-A line used to hoist a flag or pennant.
- HATCH**-An access opening in the deck of a ship, fitted with a hatch cover for watertight closure.
- HAWSEPIPE**-A large pipe through which the anchor cable runs from the deck out through the side.
- HAWSER**-A heavy line over 5 inches in circumference used for towing or mooring.
- HEADWAY**-The forward movement of a vessel through the water.
- HEAVE**-(1) To throw, as to "HEAVE THE LEAD" or to "HEAVE A LINE." (2) To haul in a line.
- HEAVE AROUND**-(1) The act of hauling in a line or chain by means of a capstan.
- HEAVE TO**-The act of stopping a vessel from making headway.
- HEAVING LINK**-A light weighted line thrown across to a ship or pier when coming alongside to act as a messenger for a mooring line. The weight is called a "monkey fist."
- HELMSMAN**-The person who steers a ship or boat.
- HIGHLINE**-A line rigged between two ships underway transferring personnel or light stores.
- HITCH**-(1) A knot whose loops come together in use, particularly under strain, yet is easily separated when strain is removed. (2) A method of securing a line to a hook, ring, or spar. (3) Slang for a term of enlistment.
- HOIST OUT**-To swing out and lower away a boat.
- HOLD**-The compartment aboard ship used for stowing cargo.
- HOLIDAY**-Any unscrubbed or unpainted section of a deck or bulkhead. Any space left unfinished inadvertently or through carelessness.
- IRISH PENNANT**-A loose, untidy end of a line left adrift.
- JACK**-The blue, white-starred flag flown at the bow (jackstaff) of a vessel at anchor or moored.
- JACKBOX**-A receptacle, usually secured to a bulkhead, into which are fitted telephone plugs or jacks.
- JACK-OF-THE-DUST**-The person in charge of the provision issue room.
- JACOB'S LADDER**-A portable ladder with ropes and wooden rungs, slung over the side for temporary use.
- JETTISON**-Throw over the side when emergency reduction of weight is required.
- JEW'S HARP**-A ring or shackle at the upper end of a shank of an anchor to which the anchor chain is secured.
- JURY RIG**-Temporary or makeshift device, rig, or piece of equipment.
- KAPOK**-A natural, light, waterproof fiber used in stuffing life jackets.
- KEEL**-The lowermost central strength member of a ship which runs fore and aft, and from which rise the frames and plating.
- KING POSTS**-Vertical posts supporting cargo booms of cargo ships.
- KINK**-A twist that disturbs the lay of line or wire.
- KNIFE EDGE**-The rim of a door frame, hatch, or post that meets the gasket for a watertight fit.
- KNOT**-(1) A unit of speed equal to 1 nautical mile (6,080 feet) per hour. (2) A collective term for hitches and bends.
- LAGGING**-The insulation surrounding pipes aboard ship.
- LANYARD**-A strong line made fast to an object to secure it, or to trigger a firing mechanism such as a firing lanyard.
- LASH**-To secure by line or wire by wrapping and tying or by chain.

- LATITUDE**-The measure of angular distance in degrees, minutes, and seconds of arc from 0° to 90° north or south of the equator.
- LAUNCH**-(1) To float a ship upon completion of building. (2) An open powerboat.
- LAY**-(1) Expresses the idea of “to move oneself,” as “Lay (yourself) up on the main deck.” (2) The direction of the twist of strands of a rope.
- LEAD**-A weight used in taking soundings.
- LEE**-(1) The direction toward which the wind is blowing or the opposite direction from which the wind is blowing. (2) A sheltered area to leeward of a ship or other windbreaker.
- LEEWARD**-Position away from the wind.
- LEEWAY**-(1) The drift of an object, with the wind, on the water's surface. (2) The sideward motion of a ship due to wind and current. (3) The difference between a ship's heading (course steered) and a ship's track (course made good); sometimes called drift.
- LIFELINE**-(1) Any line secured along the deck to lay hold of in heavy weather. (2) Any line used to assist personnel. The lifelines between stanchions along the outboard edges of a ship's weather decks are all loosely referred to as lifelines; specifically, the top line is the lifeline, the middle line is the housing line, and the bottom line is the fast line.
- LINE**-A general term for rope, either fiber or synthetic.
- LONGITUDE**-A measure of angular distance in degrees, minutes, and seconds east or west of the prime meridian at Greenwich.
- LOOKOUT**-A person stationed as a visual watch; horizon, surface, fog, and so forth.
- LUCKY BAG**-A locker usually maintained by the master-at-arms used to stow personal gear left adrift and deserter's effects.
- MACNAMARA LACE**-Fancy curtains and trimmings for barges and gigs worked from unlaid canvas threads.
- MAGAZINE**-A compartment aboard ship or ashore fitted for the stowage of ammunition. All magazines are fitted with sprinkler systems for flooding in case of fire.
- MANNED AND READY**-A report made by a guncrew or watch station when all hands are present and ready for action.
- MANNING THE RAIL**-An all-hands evolution where the ship's crew line up along the ship's rail to honor some person or occasion.
- MANROPE**-A safety line, or any line rigged to assist personnel in ascending or descending.
- MARLINE**-Small stuff (line) usually made up now of synthetic line.
- MARLINESPIKE**-A tapered steel tool for separating strands of rope or wire in splicing.
- MASTER-AT-ARMS**-A member of a ship's police force.
- MATERIAL CONDITION**-State of damage-control readiness within a ship. Designated conditions of readiness are X, Y, and Z.
- MEDITERRANEAN MOOR**-The mooring of a ship with its stern to a seawall and bow kept from swinging by anchors placed ahead while maneuvering in; used much by the U.S. Sixth Fleet.
- MESSENGER**-(1) A light line used to carry across a hawser. (2) Person who carries messages.
- MIDWATCH**-The watch beginning at 0000 and ending at 0400.
- MIND YOUR RUDDER**-The caution to the steersman to steer a more precise course or to be alert to some special circumstance.
- MOORING**-(1) The securing of a ship to a pier or wharf or to a mooring buoy. (2) Anchoring with two anchors connected to a single chain by means of a mooring swivel.
- MOORING LINE**-A line used specifically for securing a ship to a pier.
- MORNING WATCH**-The watch from 0400 to 0800.
- MOUSING**-(1) A seizing of line across a hook to prevent a sling from slipping off.
- PARCEL**-The act of wrapping a line or wire with strips of canvas.
- PAY OUT**-The act of slacking off or easing out a line.
- PELICAN HOOK**-A quick-release device made in various sizes. May be opened while under strain by knocking away a locking ring that holds it closed.
- PENDANT**-A length of wire; often fitted with an eye at one or both ends.

- PETTY OFFICER OF THE WATCH-** Enlisted member assigned duty as assistant to the officer of the deck.
- PIER-** A structure for mooring vessels which is built out into the water perpendicular to the shoreline.
- PILOT-** (1) An expert on local harbor and channel conditions who advises the commanding officer when moving a ship in or out of port. (2) One who operates an airplane.
- PILOTHOUSE-** A compartment on the bridge centerline housing the main steering controls. Also called the wheelhouse.
- PITCH-** The vertical rise and fall of a ship's bow and stern.
- PLAN OF THE DAY-** A schedule of unit activities for the day, including work, training, meals, etc.
- PLANK OWNER-** A person who has been on board since the ship was commissioned.
- PORT-** To the left of centerline as you face forward.
- PROPERTY PASS-** Written permission permitting personnel to take property from a ship or station.
- QUARTER-** The after section of a ship on either side.
- QUARTERDECK-** (1) An area of the deck on a Navy ship that is the watch station of the officer of the deck in port. (2) An area on the weather deck designated by the commanding officer for official functions, usually adjacent to the starboard or port gangway.
- QUARTERS-** (1) An assembly of personnel (as morning quarters) for muster or inspection. (2) Government-owned housing assigned to naval personnel. (3) Living spaces aboard ship.
- RADIO CENTRAL-** Main radio space aboard ship.
- RANGE-** (1) The distance an object is from the observer or reference point. (2) An area designated for a particular purpose such as a target or degaussing range.
- RAT GUARD-** A hinged conical metal shield secured around mooring lines, immediately after mooring, to prevent rats from coming aboard the ship.
- RAT-TAILED STOPPER-** A braided tapering stopper used on boat falls and mooring lines.
- RELATIVE BEARING-** The direction of an object relative to the ship's heading, expressed in degrees or in points.
- RIG-** (1) To devise; set up or arrange. (2) The act of setting up any device or equipment containing rigging.
- RIGGING-** (1) The lines, turnbuckles, ropes, and other gear supporting and attached to stacks, masts, and topside structures (called standing rigging). (2) Lines, wires, and tackles that are adjustable or control motion (called running rigging).
- RIGHT-LAID-** Refers to lay of line or wire rope in which the strands spiral in a clockwise direction (as one looks along the line).
- ROLL-** The side-to-side movement of a ship.
- RULES OF THE ROAD-** The regulations set forth to prevent collisions of ships in inland waters and at sea.
- RUNNING LIGHT-** Any light required by law to be shown by a vessel or aircraft underway.
- SAIL LOCKER-** The stowage area for awnings and related deck gear aboard ship.
- SAMSON POST-** A vertical timber on the forward or aft weather deck, used in underway replenishment, towing, and securing.
- SCREW-** (1) The propeller of a ship. (2) Screws also refer to the water in the vicinity of the propellers.
- SCULL-** The act of propelling a small boat by working oars from one side to another.
- SCUTTLE-** (1) A small, quick-closing watertight hole. (2) To sink a vessel by deliberate flooding.
- SCUTTLEBUTT-** (1) A drinking fountain aboard ship. (2) Rumor or gossip.
- SEXTANT-** A navigational instrument used to measure the distance between two ships. Used mainly on the ship's bridge.
- SHAFT ALLEY-** The space(s) in a ship through which the propeller shafts extend from the engine room(s) aft to the screws.
- SHIFT COLORS-** To shift the national ensign and jack from the flagstaff to the gaff on getting underway, or from the gaff to the flagstaff upon mooring or anchoring.
- SHORE-** (1) A portable wooden or steel beam used in damage control. (2) To brace, as to "shore up." Also called shoring. (3) Land at the edge of the sea.
- SHORT STAY-** When the anchor has been hove in just short of breaking water.

- SHOT**-A length of anchor chain, when joined with others, which makes up the anchor cable. A standard shot is 15 fathoms long.
- SHOT LINE**-A light nylon line used in a line-throwing gun.
- SIDE LIGHT**-Any one of the colored lights, red (port) and green (starboard), required by the Rules of the Road to be shown by a vessel underway.
- SILENCE**-The command given by any member of a weapons crew who observes a serious casualty or situation that requires immediate attention.
- SINGLE UP**-The command given before unmooring a ship from a pier or wharf. To take in all double sections of line between the ship and the pier, leaving the vessel moored only by a single line to the bits.
- SLACK**-(1) To ease out a line. (2) The loose part of a line that takes no strain.
- SLUSH**-(1) The act of applying preservative to a line or wire. (2) The preservative substance so applied.
- SMALL STUFF**-A general term for any fiber line less than 1 3/4 inches in circumference.
- SNAKING**-Netting rigged between the housing line or footrope and the waterway bar to prevent objects on deck from going overboard.
- SNATCH BLOCK**-A single-sheaved block with a hinged strap, which can be quickly opened to take the bight of a line, making it unnecessary to reeve the end of the line through the block. A great convenience for handling line on deck.
- SNUB**-To stop the payout of a running line, allowing only enough movement so it will not part.
- SOPA**-Abbreviation for senior officer present afloat.
- SPAN**-(1) A line made fast at both ends with a tackle, line, or fitting made fast to its bight. (2) Wire rope stretched between davit heads to which lifelines are secured.
- SPAN WIRE**-The steel cables between ships during underway replenishment that supports the fuel hose, or by which cargo is transferred.
- SPAR BUOY**-Type of buoy tapered at one end, floating upright.
- SPECIAL SEA AND ANCHOR DETAIL**-Those personnel assigned duties in connection with getting underway, mooring, or anchoring-normally when entering or leaving port.
- SPRING LINE**-Any mooring line that does not lead at right angles with the ship or pier to which moored.
- SQUALL**-A short intense windstorm, often accompanied by rain or snow.
- SQUARE AWAY**-(1) To straighten out, make shipshape, or to get settled in a new job. (2) To inform someone in an abrupt manner.
- STADIMETER**-An instrument for measuring distance to objects of known height by mechanical solution of a right angle. Commonly used to measure distance to other ships in formation.
- STANCHION**-(1) Any vertical metal post or column supporting the overhead. (2) Any similar device supporting handrails, manropes, or lifelines.
- STAND BY**-(1) To wait. (2) To substitute for someone who has the duty. (3) A preparatory expression, e.g., stand by: take in all lines.
- STANDING LIGHTS**-The dim, red lights throughout a ship's interior to enable the crew to move about safely after lights out. They are red because that color least impairs night vision.
- STARBOARD**-Directional term for right, as opposed to port, which means left.
- STATION**-(1) To assign. (2) A post of duty, as a battle station. (3) A position in formation of ships. (4) A naval activity.
- STAY**-A wire supporting a mast fore and aft.
- STEADY**-An order to the helmsman, meaning to steady the ship on whatever heading the ship comes to.
- STERN FAST**-A stern line used to secure a boat.
- STERN HOOK**-A member of a boat's crew who stands aft and makes the boat's stern secure.
- STOW**-To put away or secure articles in a space aboard ship.
- SWAB**-The Navy equivalent of a mop. (Never called a mop.)
- TACKLE**-The arrangement of line and blocks to gain a mechanical advantage.
- TAG LINE**-A line used to steady a load being swung in or out. Also called a steadying line.
- TAKE A TURN**-To pass a line around a cleat or bits. Usually followed by an order to hold it, check it, or ease it.

TAKE IN-A command to take aboard a designated mooring line or lines.

THWARDS-The cross seats in a boat just below the gunwales.

TIDE-Vertical rise and fall of the ocean level caused by the gravitational forces of the moon and sun.

TILLER-The handle that turns the rudder on a boat.

TRAIN IN AND SECURE-Put away all equipment and cease the present exercise.

TRUE BEARING-The direction of an object, relative to true instead of magnetic north.

TRUE HEADING-The horizontal direction in which a ship is heading, relative to true north.

TRICE-To haul up, as in tricing all bunks; meaning to raise all bunks and secure them in that position.

UNLAY-To untwist and separate the strands of a rope.

VEER-(1) To let out or to pay out a chain or line. (2) To slack off.

VERY WELL-A response sometimes given by a senior officer to a junior who has made a report to the

officer. (This term is never used by enlisted personnel.)

VOID-An empty space below decks.

WAKE-The water disturbed at the stern of a moving ship.

WALK BACK-The act of walking back slowly and carefully, usually used in connection with hoisting a boat by hand.

WARDROOM-Where officers eat meals on board ship; serves also as a lounge.

WATCH-A duty period, normally 4 hours long.

WATERWAY-Gutter under lifelines to carry off deck water through the scuppers.

WEATHER DECK-Any deck or portion of a deck exposed to the elements.

WILDCAT-The drum part of an anchor windlass that engages and moves the anchor chain

WINDWARD-Movement toward the wind.

WORD-News, information.

APPENDIX II

REFERENCES USED TO DEVELOP THE TRAMAN

Chapter 1

Communication Instructions General, ACP 121, The Joint Chiefs of Staff, Washington, D.C., 1983.

Standard Organization and Regulations of the U.S. Navy, OPNAVINST 3120.32B, Department of the Navy, Washington, D.C., 1986.

Chapter 2

Dutton's Navigation and Piloting, Fourteenth Edition, Naval Institute Press, Annapolis, Md., 1985.

International Code of Signals, Pub. No. 102, Defense Mapping Agency Hydrographic/Topographic Center, Washington, D.C., 1990.

Lookout Training Handbook, NAVEDTRA 12968, Naval Education and Training Program Management Support Activity, Pensacola, Fla., 1991.

Standard Organization and Regulations of the U.S. Navy, OPNAVINST 3120.32B, Department of the Navy, Washington, D.C., 1986.

Chapter 3

Naval Ships' Technical Manual, S9086-UU-STM-010, Chap. 613, "Wire and Fiber Rope and Rigging," Commander, Naval Sea Systems Command, Washington, DC., 1988.

Chapter 4

Naval Ships' Technical Manual, S9086-TV-STM-000, Chap. 581, "Anchors and Anchoring," Commander, Naval Sea Systems Command, Washington, D.C., 1980.

Naval Ships' Technical Manual, S9086-TX-STM-010/CH-583, Chap. 583, "Boats and Small Craft," Commander, Naval Sea Systems Command, Washington, D.C., 1990.

Naval Ships' Technical Manual, S9086-TM-STM-000/CH-573, Chap. 573, "Booms," Commander, Naval Sea Systems Command, Washington, D.C. 1984.

Naval Ships' Technical Manual, S9085-TW-STM-010, Chap. 582, "Mooring and Towing," Commander, Naval Sea Systems Command, Washington D.C., 1990.

Navy Occupational Safety and Health (NAVOSH), OPNAVINST 5100.19B, Vol. 1, Office of the Chief of Naval Operations, Washington, D.C., 1989.

Replenishment at Sea, NWP 14, Office of the Chief of Naval Operations, Washington, D.C., 1989.

Underway Replenishment Hardware and Equipment Manual, S9570-AD-CAT-010, Commander, Naval Sea Systems Command, Washington, D.C., 1988.

Chapter 5

Dutton's Navigation and Piloting, Fourteenth Edition, Naval Institute Press, Annapolis, Md., 1985.

Naval Ships' Technical Manual, S9086-TX-STM-010/CH-583, Chap. 583, "Boats and Small Craft," Commander, Naval Sea Systems Command, Washington, D.C., 1990.

U.S. Department of Transportation, *Navigation Rules, International-Inland*, COMDTINST M16672.2B, United States Coast Guard, Washington, D.C. 1990.

United States Navy Regulations, Department of the Navy, Washington, D.C., 1990.

Chapter 6

Principles of Naval Ordnance and Gunnery, NAVEDTRA 12970, Naval Education and Training Program Management Support Activity, Pensacola, Fla., 1992.

INDEX

A

- Accommodation ladders, 4-18
- Ammunition, 6-1
 - classification, 6-2
 - color codes, markings and letterings, 6-1
 - identification, 6-1
 - magazines, 6-7
 - projectiles, 6-3
 - propelling charges, 6-6
- Anchors, 4-1
 - anchor windlass, 4-9
 - chain and appendages, 4-3
 - heaving line, 4-12
 - lightweight, 4-3
 - mushroom, 4-3
 - stock, 4-3
 - stockless, 4-1
 - two-fluke balanced-fluke, 4-3

B

- Boat booms, 4-20
- Boat calls, 5-14
- Boat crew duties, 5-6
 - boat engineer, 5-8
 - boat keeper, 5-8
 - boat officer, 5-8
 - bow and stern hooks, 5-8
 - coxswain, 5-6
- Boat davits, 4-12
 - safety devices, 4-16
 - types and configurations, 4-15
- Boat equipment, 5-5
 - upkeep and maintenance, 5-5
- Boat etiquette, 5-11

- Boat hails, 5-13
- Boat nomenclature, 5-1
- Boat operations, 5-8
 - hoisting and lowering, 5-8
 - landing, 5-9
 - ready lifeboat, 5-11
 - securing for sea, 5-11
- Bow and flagstaff insignia, 5-13
- Breakdown and man overboard emergencies, 2-20
- Buoys, 5-26
 - international buoyage regions, 5-26
 - maritime buoyage system, 5-26

C

- Canvas, 3-25
 - awnings, 3-27
 - grommets, 3-28
 - measuring, 3-25
 - sewing, 3-26
- Cargo-handling equipment, 4-21
 - hand signals, 4-25
 - winches, 4-24
- Compasses, 2-1
 - gyrocompass, 2-1
 - magnetic compass, 2-2
 - repeaters and pelorus, 2-4
- Conditions of readiness, 1-2

D

- Deck fittings, 4-17
 - bits, 4-18
 - bollards, 4-18
 - chocks, 4-18
 - cleats, 4-18
 - pad eyes, 4-18

Deck safety, 4-44
 shackles and turnbuckles, 4-46
 winches, cranes, and anchor windlass, 4-46
Displaying national ensign, 5-12
Displaying personal flags and pennants, 5-12

F

Fairleads, kinks, and twists, 3-9

G

Ground tackles, 4-1
 care, 4-8
Gun mounts, 6-15
 tiring equipment, 6-16
 positioning equipment, 6-15
Gun systems, 6-18
 5"/54 MK 42, 6-18
 5"/54 MK 45, 6-19
 76-mm MK 75, 6-21

H

Hot-gun crew, 6-22

I

In-port watches, 1-3
 pier sentries, 1-4
 security watches, 1-4
 side boys, 1-3
 telephone watch, 1-3
Interior communications
 shipboard announcing system, 2-17
 sound-powered phones, 2-15
 telephone system, 2-15
 voice tube, 2-17

K

Knots, 3-10
 bending to a hook, ring, or spar, 3-13
 form a loop or eye, 3-13

L

Leather, 3-29
 care, 3-29
 sewing, 3-29
Lookouts' equipment, 2-19
 binocular, 2-19
 foul-weather gear, 2-20

M

Magnetic compass error, 2-3
 deviation, 2-3
 variation, 2-3
Making up a line, 3-7
Mooring, 4-41
 block and tackle, 4-44
 standing rigging, 4-44

N

Natural fiber line, 3-6
 measuring, 3-6
 strengths, 3-6
Navigational lights, 2-10
 anchor lights, 2-14
 running lights, 2-10
 signal lights, 2-12
 standing lights, 2-14

O

Ordnance-handling safety, 6-14

P

Pyrotechnics, 6-8
 handling and storage, 6-13

Pyrotechnics-Continued

- marine location markers, 6-9
- pyrotechnic pistols, 6-12

R

Replenishment rigs, 4-32

- Burton method, 4-34
- close-in method, 4-33
- emergency breakaway, 4-34
- span-wire method, 4-32
- STREAM method, 4-33
- synthetic highline, 4-34

Replenishment safety precautions, 4-36

Rope, 3-1

- construction of line, 3-1
- use and care of line, 3-2

Rules of the road, 5-18

- distress signals, 5-25
- general definitions, 5-20
- maneuvering and warning signals, 5-21
- restricted visibility, 5-23
- steering and sailing rules, 5-19

S

Seaman aloft, 4-37

- boatswain's chair, 4-37
- riding down standing rigging, 4-38

Securing ends of line, 3-8

Small stuff, 3-2

- size, 3-3
- use of small stuff, 3-3

Splices, 3-14

- eye splice, 3-15
- sailmaker's splice, 3-17
- short splice, 3-17

Steering and speed control equipment, 2-5

- engine order telegraph, 2-7

Steering and speed control equipment-Continued

- engine revolution telegraph, 2-7
- fathometer, 2-10
- rudder angle indicator, 2-6
- steering engines, 2-5
- steering stations, 2-6

Steering by compass, 5-15

- compass error, 5-15
- correcting compass course, 5-17

Synthetic fiber lines, 3-4

T

lime, 1-7

- Greenwich mean time, 1-8
- prime meridian, 1-8

Tools, 3-10

Types of boats, 5-2

- landing craft, 5-2
- motor whaleboat, 5-3
- personnel boats, 5-3
- punts, 5-4

U

Underway replenishment, 4-25

- line-throwing gear, 4-31
- phone/distance line, 4-30
- sound-powered phones, 4-30

Underway watches, 1-4

- Boatswain's Mate of the watch, 1-5
- fog watch, 1-7
- helmsman, 1-5
- junior officer of the deck (JOOD), 1-4
- lee helmsman, 1-6
- lifeboat watch, 1-7
- lookout, 1-7
- officer of the deck (GOD), 1-4
- Quartermaster of the watch, 1-5

V

Vertical replenishment, 4-35

W

Watches, 1-1

 duties of a messenger, 1-2

 duties of a watchstander, 1-1

 messages, 1-2

 type of watches, 1-1

Wire rope, 3-18

 care, 3-19

Wire rope-Continued

 clips, 3-24

 construction, 3-18

 failure, 3-22

 lubrication, 3-22

 seizing, 3-23

 storage, 3-22

 use, 3-19

Working over the side, 4-38

 lead line, 4-40

 reeving gantlines, 4-40

 stage, 4-39

Assignment Questions

Information: The text pages that you are to study are provided at the beginning of the assignment questions.

ASSIGNMENT 1

Textbook Assignment: "Watches" and Watchstanders' Equipment," chapters 1 and 2, pages 1-1 through 2-14.

- 1-1. Which of the following is NOT a requirement for maintaining a 24-hour watch aboard ship?
1. Security of the ship
 2. Safety of personnel
 3. Guarding supplies, weapons, and equipment
 4. Informing other ships of condition of your ship
- 1-2. Which of the following is the morning watch?
1. 0000-0400
 2. 0400-0800
 3. 0800-1200
 4. 1200-1600
- 1-3. Which of the following watches is usually dogged at sea?
1. 0400-0800
 2. 0800-1200
 3. 1200-1600
 4. 1600-2000
- 1-4. The term "watch" may be defined as a period of time, a type of duty, or a location.
1. True
 2. False
- 1-5. For what reason is the dogged watch needed aboard ship?
1. For eating the evening meal only
 2. For rotating watches only
 3. For eating and rotating watch
 4. For the passing of information to the oncoming watchstander
- 1-6. The oncoming watchstander should relieve the off-going messenger before he turns over any information concerning the watch.
1. True
 2. False
- 1-7. You are relieving the forenoon watch. For what reason should you report to your station 30 minutes early?
1. To find out what section has the watch
 2. To allow the off-going watch to eat chow
 3. To allow information to be passed from the off-going person to the oncoming person
 4. To get off watch 30 minutes early
- 1-8. What general degree of readiness requires part of a ship's weapons systems be ready for immediate action at prolonged notice?
1. I
 2. II
 3. III
 4. IV
- 1-9. You are standing messenger watch on the bridge underway. Your ship goes into readiness condition IA. You should be engaged in what operation?
1. ASW operations
 2. Amphibious operations
 3. Peacetime operations
 4. ASU operations for prolonged periods

- 1-10. Which of the following duties is NOT a requirement for the messenger of the watch?
1. Being in the proper uniform
 2. Remaining uncovered in officer country
 3. Obtaining permission from the petty officer of the watch before going to lunch
 4. Delivering messages quickly and directly
- 1-11. You are the messenger of the watch during the noon meal. You have a message for the Chief Signalman. Upon entering the CPO mess you should remain covered.
1. True
 2. False
- 1-12. You are answering an incoming phone call. Which of the following information is NOT required upon picking up the receiver?
1. Your name
 2. Your command
 3. Your position
 4. Your CO's name
- 1-13. As a phone watch messenger, you receive a call for someone who is not present. Which of the following notations should you make?
1. Name of the caller and time the message was received only
 2. The message and time only
 3. Name of the caller, the message, the time the message was received, and your name
 4. Name of the caller, the message, and your name only
- 1-14. The Boatswain's Mate piped four veers on the Bos'n pipe. How many side boys are needed?
1. Six
 2. Two
 3. Eight
 4. Four
- 1-15. In rendering honors with side boys, when does the call OVER THE SIDE begin?
1. As soon as the visitor's boat or vehicle comes within hailing distance
 2. As soon as the visitor's head appears at the quarterdeck level
 3. As soon as the visitor's boat or vehicle pulls alongside
 4. As soon as the visitor steps on the quarterdeck
- 1-16. You are serving as a side boy. At what call of the Boatswain's pipe should you render the hand salute?
1. ATTENTION
 2. ALONGSIDE
 3. WALK BACK
 4. OVER THE SIDE
- 1-17. You are assigned a security watch aboard ship. At least how often should you make reports to the officer of the deck (OOD)?
1. Every 15 min
 2. Every 30 min
 3. Every 45 min
 4. Every hour
- 1-18. While standing an anchor watch, you notice that the line tends forward and there is no slack. What is the probable condition of the anchor?
1. The ship is surging aft
 2. The ship is surging forward
 3. The ship is dragging anchor
 4. The ship is veering around the anchor
- 1-19. To what officer does the OOD report concerning the carrying out of the ship's routine?
1. Commanding officer
 2. Executive officer
 3. Navigator
 4. Junior officer of the deck

- 1-20. What member of the underway bridge watch team is responsible for entering all data required by current instructions in the ship's log?
1. QMOW
 2. OOD
 3. JOOD
 4. BMOW
- 1-21. What individual must qualify you before you can assume the duties of helmsman?
1. OOD
 2. JOOD
 3. Navigator
 4. Executive officer
- 1-22. It is much harder to hold a ship steady on some object ahead than to keep on course by compass.
1. True
 2. False
- 1-23. What individual orders the course the helmsman steers?
1. Officer of the deck
 2. Conning officer
 3. Navigator
 4. Commanding officer
- 1-24. Which of the following is one of the most important principles to remember as a helmsman?
1. The wheel, the rudder, and the ship's head all move in the same direction
 2. The compass card turns under the ship
 3. The wheel and the rudder turn opposite
 4. The lubber line remains stationary
- 1-25. Which of the following errors is usually committed most often by a new helmsman?
1. Failing to correct ship's heading
 2. Failing to repeat every command
 3. Not using enough rudder
 4. Using too much rudder
- 1-26. You are being relieved as the helmsman. What information should you pass on to your relief?
1. The course you are steering
 2. The engineering plant status
 3. The surrounding contacts
 4. The sea condition
- 1-27. Which of the following is the correct terminology for a course change?
1. RIGHT FULL RUDDER
 2. FULL RUDDER RIGHT
 3. RUDDER RIGHT FULL
 4. RUDDER FULL RIGHT
- 1-28. The conning officer orders LEFT FULL RUDDER. How many degrees should you bring the rudder left of center?
1. 10°
 2. 20°
 3. 30°
 4. 40°
- 1-29. What order should the conning officer give to inform you to put the rudder over to the left at the maximum degrees allowed by your ship?
1. LEFT FULL RUDDER
 2. HARD LEFT RUDDER
 3. LEFT HARD RUDDER
 4. RUDDER HARD LEFT
- 1-30. What order should the conning officer give the helmsman to put the rudder on the centerline?
1. MEET HER
 2. EASE YOUR RUDDER
 3. MIDSHIPS
 4. STEADY

- 1-31. You are the helmsman and the conning officer orders you to shift your rudder. What action should you take?
1. Change to the same number of degrees of the opposite rudder angle
 2. Shift from helmsman to lee helmsman
 3. Steady the ship on the course given at the time of the order
 4. Reduce rudder angle
- 1-32. What does the order NOTHING TO THE RIGHT mean?
1. Turn left
 2. Hold the rudder amidships or left of amidship
 3. Keep the ship from swinging to the right of a given course
 4. Keep the ship from swinging to the left of a given course
- 1-33. You are standing watch as the lee helmsman. Where should you be standing your watch?
1. After steering
 2. Behind the helmsman
 3. At the gyro
 4. At the engine order telegraph
- 1-34. To inform the helmsman to stop both engines, what order should the conning officer give?
1. STOP BOTH ENGINES
 2. STOP THE PORT AND STARBOARD ENGINES
 3. ALL ENGINES STOP
 4. STOP ALL ENGINES
- 1-35. You are fog lookout aboard your ship. You hear the fog signal of an approaching ship. To what individual should you report this information?
1. The commanding officer
 2. The officer of the deck
 3. The navigator
 4. The BMOW
- 1-36. You are informed by your leading petty officer that you have been assigned to the ready lifeboat. Upon mustering at the designated area, you are required to remain at that area until you are relieved.
1. True
 2. False
- 1-37. What officer is responsible for training lookouts in the performance of their duties?
1. The CIC officer
 2. The officer of the deck
 3. The commanding officer
 4. The navigator
- 1-38. How often should surface lookouts be relieved?
1. Every half-hour
 2. Every hour
 3. Every 2 hours
 4. Every 4 hours
- 1-39. At what position aboard ship should you find the life buoy watch?
1. The forecastle
 2. The port bridge wing
 3. The starboard bridge wing
 4. The aft designated station
- 1-40. You are assigned as aft lookout. How often should you check sound-powered communications with the bridge?
1. Every 15 min
 2. Every 30 min
 3. Every 45 min
 4. Every 60 min
- 1-41. The Earth consists of 24 zones. Each zone contains a total of how many degrees?
1. 10°
 2. 15°
 3. 20°
 4. 25°

- 1-42. You are in zone zero, longitude east at 1300 local time. What operation should you perform using the zone number to obtain Greenwich Mean Time?
1. Multiply
 2. Add
 3. Divide
 4. Subtract
- 1-43. Which of the following letters is NOT assigned as a zone letter?
1. A
 2. D
 3. J
 4. Y
- 1-44. It is the fourth day of the month. You have the 2000-2400 watch. Midway through the watch your ship crosses the international date line, eastbound. Which of the following times indicates the time you should be relieved?
1. 022345M
 2. 022345Y
 3. 032345M
 4. 032345Y
- 1-45. What is the proper zone designation for Greenwich Mean Time (GMT)?
1. HOTEL
 2. MIKE
 3. XRAY
 4. ZULU
- 1-46. In writing the letter Z, a horizontal bar is placed through the letter Z to prevent it from being mistaken as the number 2.
1. True
 2. False
- 1-47. Your ship is in time zone +5R at local time 1500. What is the Greenwich Mean Time?
1. 1500
 2. 2000
 3. 2200
 4. 2400
- 1-48. What causes a gyrocompass to operate?
1. Attraction exerted by the Earth
 2. Magnetic properties of the ship
 3. True direction of the north pole
 4. Gyro principle of a spinning wheel
- 1-49. Why is the magnetic compass used aboard ship as the standard compass rather than the gyrocompass?
1. A gyrocompass is affected by deviation
 2. A gyrocompass does not point to true north
 3. A magnetic compass is not affected by deviation
 4. A magnetic compass is not affected by failure of the ship's power supply
- 1-50. What element of the magnetic compass keeps the compass bowl level, regardless of the ship movement?
1. The binnacle
 2. The gimbals
 3. The pelorus
 4. The sphere
- 1-51. Your ship is in an area that has an 8° easterly variation. If your ship's true course is 080°, what magnetic course is being steered?
1. 070°
 2. 072°
 3. 080°
 4. 080°
- 1-52. Magnetic compass error is a combination of errors caused by what element(s)?
1. Electrical current in the atmosphere
 2. Gravitational pull
 3. Variation and deviation
 4. Precession

- 1-53. The magnetic compass error called variation is caused by which of the following facts?
1. The Earth is not perfectly round
 2. Compasses cannot be constructed without mechanical defects
 3. Positions of the magnetic and geographic poles are not the same
 4. Metals in ships have magnetic qualities
- 1-54. The magnetic steering compass is usually located topside, while the standard compass is located in the pilothouse.
1. True
 2. False
- 1-55. For what reason are the gyro repeaters placed on the bridgewings?
1. To take position angles on aircraft
 2. To steer by in fair weather
 3. To take bearings
 4. To correct for magnetic compass deviation
- 1-56. What bearing is the direction of an object as indicated by the magnetic compass?
1. Compass
 2. True
 3. Relative
 4. Position
- 1-57. You are the forward lookout and observe a contact on the port beam. What bearing should you report to the bridge?
1. 000°
 2. 090°
 3. 180°
 4. 270°
- 1-58. How many degrees are contained in each point of the compass card?
1. 011 1/4°
 2. 012°
 3. 016°
 4. 020°
- 1-59. What is the reciprocal bearing of your ship if your course is 230°?
1. 050°
 2. 090°
 3. 180°
 4. 280°
- 1-60. What type of steering engine is used on most vessels of recent design?
1. Mechanical
 2. Steam
 3. Electrohydraulic
 4. Electromechanical
- 1-61. What is the function of the steering gear follow-up shaft?
1. To stop the pumping of oil when the rudder reaches the desired angle
 2. To turn the rudder mechanically in an emergency
 3. To supply oil to the running pump in an emergency
 4. To allow the trick wheel to be engaged for local steering
- 1-62. What safety device stops the rudder movement when the rudder is brought against the stops?
1. Single-ram
 2. Double-ram
 3. Steering engine cutoff
 4. Steering engine cutout
- 1-63. What signal alerts the helmsman in after steering that the bridge has ordered a change in rudder angle?
1. A flashing red light
 2. A flashing white light
 3. A whistle
 4. A bell

- 1-64. What instrument communicates speed orders to the engine room?
1. Rudder angle indicator
 2. Engine order telegraph
 3. Engine revolution indicator
 4. Depth sounder
- 1-65. What instrument is used to enable the helmsman to make minor speed changes?
1. Rudder angle indicator
 2. Engine order telegraph
 3. Engine revolution telegraph
 4. Depth sounder
- 1-66. How does the fathometer measure the depth of water?
1. By the water pressure at the bottom
 2. By the amount of wire required to place the lead on the bottom
 3. By the time required for a lead to sink to the bottom
 4. By the time required for sound to travel to the bottom and back

IN ANSWERING QUESTIONS 1-67 THROUGH 1-69, SELECT FROM COLUMN B THE DEGREES THAT INDICATE THE LIGHT IN COLUMN A.

	<u>A. LIGHT</u>	<u>B. DEGREES</u>
1-67.	Stern	1. 112 1/2°
1-68.	Masthead	2. 135°
1-69.	Side lights	3. 225°

- 1-70. The control panel for a ship's running lights is located in what area?
1. The pilothouse
 2. The forecastle
 3. The signal bridge
 4. The after steering

- 1-71. What total length does a ship have to be to require a second masthead light?
1. 25 meters
 2. 35 meters
 3. 40 meters
 4. 50 meters
- 1-72. What lights are installed at the truck and extend 25 feet above the highest point of the superstructure?
1. Steering lights
 2. Speed lights
 3. Blinker lights
 4. Aircraft warning lights
- 1-73. What red lights are located 6 feet vertically apart and are mounted on brackets that extend abaft the mast?
1. Steering
 2. Breakdown and man-overboard
 3. Blinker
 4. Wake
- 1-74. What light is installed on the jackstaff, the spar, or the structure, and must be visible to the helmsman?
1. Steering
 2. Stem
 3. Wake
 4. Breakdown
- 1-75. Speed lights are combination red and white lights. What does the white light signal indicate?
1. Backing
 2. Stopping
 3. Ahead speeds
 4. Astern speeds

ASSIGNMENT 2

Textbook Assignment: "Watchstander's Equipment" (continued) and "Marlinespike Seamanship," chapters 2 and 3, pages 2-11 through 3-30.

IN ANSWERING QUESTIONS 2-1 THROUGH 2-4,
SELECT FROM COLUMN B THE SPEED REQUIRED
FOR THE PULSATING LIGHT IN COLUMN A.

	<u>A. SPEED</u>	<u>B. PULSATION</u>
2-1.	One-third speed ahead	1. Four white flashes in 6 seconds
2-2.	Full speed ahead	2. Steady white light
2-3.	Standard speed ahead	3. One white flash in 6 seconds
2-4.	Stop	4. Steady red light

2-5. Standing lights are dim blue lights installed throughout a ship's interior.

1. True
2. False

2-6. What is the most reliable system of interior communications?

1. Messenger
2. Radio
3. Voice
4. Flashing light

2-7. What first-letter designation is assigned to sound-powered circuits?

1. J
2. S
3. T
4. X

2-8. What is the proper designation for the commanding officer's battle circuit?

1. JX
2. JW
3. JL
4. JA

IN ANSWERING QUESTIONS 2-9 THROUGH 2-12,
SELECT THE SOUND-POWERED CIRCUIT LISTED IN
COLUMN B THAT IS CONTROLLED BY THE OFFICER
LISTED IN COLUMN A.

	<u>A. OFFICER</u>	<u>B. CIRCUIT</u>
2-9.	Weapons officer	1. JZ
2-10.	Navigation officer	2. 1JV
2-11.	DCA	3. JC
2-12.	Conning officer	4. JW

2-13. The voice tube is the primary means of interior communication on most patrol boats.

1. True
2. False

2-14. What communication circuit aboard ship is used to pass general information to all hands?

1. 1MC
2. 2MC
3. 3MC
4. 4MC

2-15. What communication circuit is the general announcing system for the hangar deck area?

1. 1MC
2. 2MC
3. 3MC
4. 21MC

2-16. When you are using the 24MC to communicate with the signal bridge, what signal indicates that the receiving station is ready to receive?

1. A steady buzzing sound
2. A pulsating buzzing sound
3. A steady red light
4. A blinking red light

- 2-17. What MC circuit is the combat information announcing system?
1. 20MC
 2. 21MC
 3. 22MC
 4. 24MC
- 2-18. Which of the following equipment are NOT normally used by lookouts?
1. Sunglasses
 2. Alidades
 3. Peloruses
 4. Binnacles
- 2-19. What is the proper way to focus a pair of binocular?
1. Adjust one eyepiece at a time, with the opposite lens covered, but with both eyes open
 2. Adjust both eyepieces at the same time
 3. Adjust one eyepiece at a time, with the opposite eye closed
 4. Adjust one eyepiece at a time, with both lenses uncovered and both eyes open
- 2-20. What focus number should you use to change the binocular setting from day to night use?
1. -1
 2. +1
 3. -4
 4. +4
- 2-21. Of the following circles, which one(s) reflect(s) a properly adjusted pair of binoculars for your inter-pupillary distance (IPD)?
1. A single circle
 2. Two circles not overlapped
 3. Three circles
 4. Overlapping circles
- 2-22. What will happen to your vision if you have the wrong IPD setting at night?
1. Objects will appear smaller
 2. Objects will appear larger
 3. Object glare will increase
 4. Light for your eyes will be cut out
- 2-23. Which of the following is NOT a procedure that should be used during the breakdown of a Navy ship at sea?
1. Hoisting two black balls, one above the other
 2. Hoisting two black balls and one diamond
 3. Hoisting the flag FIVE
 4. Sounding six or more blasts on the ship's whistles
- 2-24. What light signal should your ship display at night to indicate a breakdown?
1. Two red lights in a horizontal line
 2. Two red lights in a vertical line
 3. Two white lights in a horizontal line
 4. Two white lights in a vertical line
- 2-25. During peacetime, what night signal indicates a man overboard?
1. Two horizontal blinking red lights
 2. Two horizontal steady red lights
 3. Two vertical blinking red lights
 4. Two vertical steady red lights
- 2-26. What signal should you use to direct a lifeboat to return to the ship?
1. One red star
 2. Two red stars
 3. One green star
 4. Two green stars

IN ANSWERING QUESTIONS 2-27 THROUGH 2-30, SELECT FROM COLUMN B THE HOIST YOU SHOULD EXECUTE WHEN GIVEN THE ORDER LISTED IN COLUMN A.

	<u>A. ORDER</u>	<u>B. HOIST</u>
2-27.	STEER RIGHT	1. EIGHT
2-28.	STEER STRAIGHT TOWARD SHIP	2. QUEBEC 3. EIGHT STBD
2-29.	STEER STRAIGHT AWAY FROM SHIP	4. EIGHT SCREEN
2-30.	RETURN TO SHIP	

2-31. You are the aft lookout during the mid watch when you observe an individual fall overboard. After the lifeboat has been lowered to search for the individual, you observe a red pyrotechnic fired from the lifeboat. What information is the lifeboat signaling?

1. The lifeboat is returning to the ship
2. The lifeboat cannot find the man
3. The lifeboat needs assistance
4. The lifeboat has recovered the man

3-32. In three-strand line, fibers and strands are twisted in the same direction.

1. True
2. False

3-33. What type of braided line retains about 50 percent of its strength in the core?

1. Double-braided
2. Plaited
3. Solid-braided
4. Hollow-braided

2-34. What type of braided line should you use to construct signal halyards aboard ship?

1. Plaited
2. Solid-braided
3. Single-braided
4. Double-braided

2-35. Approximately what percent does natural fiber line deteriorate in 2 years from weathering alone?

1. 10
2. 20
3. 30
4. 40

2-36. Natural fiber line over 5 years old should only be used for operations such as lashing, matting, and fenders.

1. True
2. False

2-37. What is line that is less than 1 1/2 inches in circumference called?

1. Twine
2. Small stuff
3. Hawser
4. Marline

2-38. Which of the following factors determines the size of small stuff?

1. Diameter
2. Circumference
3. The number of threads it contains
4. The number of strands it contains

2-39. What is the most common type of small stuff used aboard ships?

1. Houseline
2. Roundline
3. Sail twine
4. Marline

- 2-40. Tattle-tale cords can be used to determine the strength of aramid (Kevlar) fiber line.
1. True
 2. False
- 2-41. What publication contains the safety precaution for handling synthetic fiber line?
1. *Naval Ships' Technical Manual*, Chapter 612
 2. *Naval Ships' Technical Manual*, Chapter 613
 3. *Naval Ships' Technical Manual*, Chapter 614
 4. *Naval Ships' Technical Manual*, Chapter 615
- 2-42. What line is recommended by NAVSEA for use aboard ships for mooring lines and tending lines?
1. Aramid fiber (Kevlar)
 2. Natural fiber
 3. Polyethylene
 4. Polypropylene
- 2-43. When synthetic line is placed under tension, line handlers should be placed how many degrees from the direction of the tension force?
1. 30°
 2. 45°
 3. 60°
 4. 90°
- 2-44. Which of the following knots is known to offer reasonable security in synthetic lines?
1. Bowline
 2. Square
 3. Reef
 4. Double carrick
- 2-45. The maximum length to which a 300-foot double-braided hawser can be stretched without parting is approximately how many feet?
1. 325
 2. 354
 3. 372
 4. 400
- 2-46. Which of the following is NOT a visual warning that synthetic line tension is exceeding its safe working limit and is in danger of parting?
1. The line begins to smoke because of the heat generated by stretching
 2. The line diameter becomes larger as stretching continues
 3. The line diameter becomes smaller as stretching continues
 4. The tattle-tale cord lays taut against the line
- 2-47. A recommended way to make up a line is to lay it out in long, flat bights. What procedure is this called?
1. Coiling
 2. Faking
 3. Flemishing
 4. Laying
- 2-48. What is the purpose for whipping a loose line?
1. To prevent unlaying
 2. To prevent chafing
 3. To prevent deterioration
 4. To prevent kinking
- 2-49. For what purpose is a wooden fid used?
1. To splice wire
 2. To splice line
 3. To splice spring lay
 4. To tighten shackles
- 2-50. What tool should you use to splice wire?
1. A fid
 2. A mallet
 3. An awl
 4. A marlinespike
- 2-51. What is the best knot to use for making a temporary eye in a mooring line?
1. Square
 2. Rose
 3. Bowline
 4. Sheepshank

- 2-52. Which of the following knots offers the best security when bending two lines together?
1. Bowline
 2. Square
 3. Becket bend
 4. Carrick
- 2-53. What is the best knot to use for bending together two lines of different sizes?
1. Square
 2. Becket bend
 3. Carrick
 4. Bowline
- 2-54. In an emergency, which bowline knot is the best for raising an unconscious crewman from a motor whale boat to the main deck?
1. French
 2. Running
 3. Bend
 4. Rolling
- 2-55. What type of hitch should be used to pass a stopper on a mooring line?
1. Half
 2. Clove
 3. Rolling
 4. Marline
- 2-56. What is the best hitch to use to bend a line to a round object?
1. Half
 2. Clove
 3. Rolling
 4. Marline
- 2-57. What type of splice should you use when a slight enlargement of the diameter of the line is of no importance?
1. Eye
 2. Short
 3. Long
 4. Sail
- 2-58. When splicing line, the number of tucks for natural and synthetic line should be the same.
1. True
 2. False
- 2-59. Galvanized wire rope ordinarily should NOT be used for which of the following purposes?
1. Hoisting
 2. Life lines
 3. Standing rigging
 4. Running rigging
- 2-60. Which of the following sizes of wire rope is the strongest of all wire rope?
1. 6 x 37
 2. 6 x 30
 3. 6 x 19
 4. 6 x 7
- 2-61. If a wire rope becomes kinked, you should try to pull the kink out by putting strain on the wire rope.
1. True
 2. False
- 2-62. Wire rope should NEVER be stowed where it can be exposed to which of the following elements?
1. High temperatures
 2. Low temperatures
 3. Greases
 4. Acid
- 2-63. A total of how many wire rope clips should you use to make a temporary eye splice in a 1-inch 6 x 7 rope?
1. One
 2. Two
 3. Five
 4. six

- 2-64. Wire rope clips should be spaced apart at a distance equal to how many times the diameter of the wire?
1. One
 2. Two
 3. Six
 4. Four
- 2-65. What tool should be used to increase tension on a wire rope 1 5/8 inches or more in diameter?
1. Fid
 2. Marlinespike
 3. Serving bar or iron
 4. Wrench
- 2-66. When working with wire rope, you should wear a pair of heavy gloves to protect your hands against which of the following hazards?
1. Kinking
 2. Jamming
 3. Fishhooks
 4. Slipping
- 2-67. What does the number designation of canvas indicate?
1. Width
 2. Thread count
 3. Thickness
 4. Weight per square yard
- 2-68. Canvas is issued by which of the following measurements?
1. Square feet
 2. Linear feet
 3. Square yards
 4. Linear yards
- 2-69. What is the recommended solution for cleaning dirty canvas?
1. Mild soap and water
 2. Strong soap and water
 3. Warm water only
 4. Mild soap only
- 2-70. Where is white, untreated canvas normally used aboard ship?
1. Above decks
 2. Below decks
 3. Aft
 4. Mid ship
- 2-71. What type of stitch should you use to mend tears in light and medium canvas?
1. Flat
 2. Round
 3. Baseball
 4. Herringbone
- 2-72. What type of synthetic cover is used to protect the ship's crew from the sun and weather?
1. Awnings
 2. Beeswax
 3. Bench hook
 4. White, untreated
- 2-73. Which of the following types of leather is NOT likely to be used aboard ship?
1. Rigging
 2. Belting
 3. Artificial
 4. Lacing

ASSIGNMENT 3

Textbook Assignment: "Deck Seamanship," chapter 4, pages 4-1 through 4-46.

- 3-1. What is the equipment used in anchoring and mooring called?
1. Rigging
 2. Connecting gear
 3. Ground tackle
 4. Turnbuckles
- 3-2. What part of the anchor digs in as it is dragged across the ocean bottom?
1. Stock
 2. Shank
 3. Wedge
 4. Fluke
- 3-3. What type of anchor is most commonly used aboard naval ships?
1. Stockless
 2. Wedge block
 3. Mushroom
 4. Stock
- 3-4. What naval stockless anchor has the greatest holding power?
1. Commercial
 2. Standard
 3. Mark 2
 4. Mark 4
- 3-5. What type of anchor is normally used in groups of three or more, surrounding a central mooring point?
1. Wedge block
 2. Danforth
 3. Stock
 4. Mushroom
- 3-6. Navy anchor chains of the flash-welded type is the standard for new ship constructions.
1. True
 2. False
- 3-7. How long is a standard shot of anchor chain?
1. 15 feet
 2. 15 fathoms
 3. 15 yards
 4. 15 meters
- 3-8. What devices are used to join standard shots of anchor chain together?
1. Bending shackles
 2. Connecting shackles
 3. Center shackles
 4. Detachable links
- 3-9. What device is used to attach the anchor to the chain?
1. Chain swivel
 2. Bending shackle
 3. Detachable link
 4. Outboard swivel shot
- 3-10. Which of the following is NOT a use of the chain stopper?
1. To hold the anchor taut in the hawsepipe
 2. To ride to an anchor
 3. To hold the anchor when the anchor is disconnected
 4. To secure a shackle permanently to the pad eye
- 3-11. What devices are used to attach the anchor chain to mooring buoys?
1. Mooring shackles
 2. Mooring swivels
 3. Chain cable jacks
 4. Clear hawse pendants

- 3-12. An anchor chain on deck shows one blue detachable link and six links on either side, with six turns of wire in the end white links. A total of how many fathoms of chain are out?
1. 45
 2. 60
 3. 75
 4. 90
- 3-13. What is the color of the detachable link at 45 fathoms?
1. Blue
 2. Green
 3. Red
 4. White
- 3-14. What is the color of the next-to-last shot of an anchor chain?
1. Blue
 2. Red
 3. White
 4. Yellow
- 3-15. As a minimum, how often should 1 1/2-inch anchor chains be laid out on deck and thoroughly examined?
1. Annually
 2. Monthly
 3. Quarterly
 4. Semiannually
- 3-16. What type windlass has its power source located below deck?
1. Electric drive
 2. Electrohydraulic drive
 3. Vertical shaft
 4. Horizontal shaft
- 3-17. What device(s) permit(s) free rotation of the wildcat when you are paying out the chain?
1. Whelps
 2. Locking head
 3. Drum
 4. Pockets
- 3-18. What term is used to describe the anchor buoy when it is floating on the surface above the anchor?
1. Dipping
 2. Listening
 3. Looking
 4. Watching
- 3-19. When weighing anchor, when is the anchor aweigh?
1. When it is free of the bottom
 2. When it is in sight
 3. When the chain is up and down
 4. When it is heaved in just short of breaking out
- 3-20. What command should be used to inform the seaman to release the brake so the chain is heaved in enough to take strain off the stopper?
1. HEAVE AROUND AND UP
 2. HEAVE AROUND TO SHORT STAY
 3. HEAVE AROUND
 4. READY TO HEAVE IN
- 3-21. Approximately how much of the heaving line is coiled and held in the casting hand?
1. 1/3
 2. 1/2
 3. 2/3
 4. 3/4
- 3-22. What device is used with davits having wire rope falls?
1. Drum
 2. Track
 3. Bull
 4. GYPSY
- 3-23. What type of mechanical boat davit handles the rescue rigid inflatable boat?
1. The crescent davit
 2. The pivot sheath davit
 3. The slewing arm davit
 4. The gravity link davit

- 3-24. What davit is mainly used aboard aircraft carriers and amphibious helicopter landing ships?
1. Pivoted
 2. Pivoted link
 3. Pivoted sheath screw
 4. Overhead suspended
- 3-25. When using a gravity boat davit, what winch devices control the boat's descending speed and prevent the davit arms from slamming into the outboard stop?
1. Handcranks
 2. Arm configurations
 3. Davits
 4. Manual brakes
- 3-26. What boat davit safety device is used to indicate when the electric motor must be deenergized during hoisting to prevent overstressing or failure of davit components?
1. Double brake feature
 2. Safe hoisting position stripes
 3. Emergency disconnect switch
 4. Fluid brake
- 3-27. The purpose of the fluid brake is to regulate the speed of a descending boat.
1. True
 2. False
- 3-28. What deck fitting should you use to make fast a line that has been led through a chock?
1. Cleat
 2. Bitt
 3. Chock
 4. Bollard
- 3-29. What deck fitting consists of a double-ended pair of projecting horns used for belaying a wire?
1. Cleat
 2. Bitt
 3. Chock
 4. Pad eye
- 3-30. There are how many types of chock?
1. One
 2. Two
 3. Three
 4. Four
- 3-31. When a naval vessel has two accommodation ladders, what personnel use the forward ladder?
1. Working parties
 2. Liberty parties and yard workers
 3. Messmen and hospital corpsmen
 4. Officers and ceremonial participants
- 3-32. What type of ladder is rigged out and lowered to provide for boarding or leaving an anchored ship?
1. Gangway
 2. Platform
 3. H-frame
 4. Accommodation
- 3-33. For ease of handling, most accommodation ladders in the Navy today are made of aluminum.
1. True
 2. False
- 3-34. On ships not having outriggers, what davit can be used to support the ladder over the side?
1. An H-frame
 2. A single-sheave block
 3. A J-bar
 4. A pad eye
- 3-35. What device is used for mooring small boats clear of a ship's side?
1. Accommodation ladder
 2. Boat boom
 3. Shroud
 4. Jacob's ladder
- 3-36. What devices control the fore and aft motion of the boat boom?
1. Pad eyes
 2. Lifelines
 3. Toggles
 4. Guys

- 3-37. A boat boom is secured to the side of a ship by what device(s)?
1. A gooseneck and a pin
 2. A roddle and a U-bolt
 3. A U-bolt and a clamp
 4. A pad eye
- 3-38. What part of the boat boom rigging is designed to permit the boat crews to come aboard ship?
1. Topping lift
 2. Guess-warp
 3. Jacob's ladder
 4. After guys
- 3-39. What equipment should you heave around on to spot the yard-and-stay booms in their working area?
1. Topping lifts
 2. Guys
 3. Whips
 4. Plumbs
- 3-40. What minimum number of steadying lines should be attached to heavy or unwieldy loads?
1. Five
 2. Two
 3. Three
 4. Four
- 3-41. Replenishment at sea is a broad term applied to all methods of transferring material and personnel at sea.
1. True
 2. False
- 3-42. What craft is needed to carry out a vertical replenishment (VERTREP)?
1. Submarine
 2. Fixed-wing aircraft
 3. Helicopter
 4. Jet aircraft
- 3-43. Which of the following ships has the primary duty of supplying ammunition to the fleet?
1. AE
 2. AO
 3. AFS
 4. AOE
- 3-44. What are the most common refueling rigs used in the Navy?
1. Probe and heavy weather
 2. Manila highline and Burton housefall
 3. Surf and Stream
 4. Span-wire and close-in
- 3-45. What flaghoist signal should the receiving ship hoist to indicate it is disengaging at final station?
1. ROMEO closed up
 2. ROMEO at the dip
 3. PREP closed up
 4. PREP at the dip
- 3-46. What color lights do replenishment rig signalmen use at night to pass orders between ships?
1. Blue, green, and red
 2. Amber, green, and red
 3. Amber, blue, and green
 4. Amber, blue, and red
- 3-47. What is the principal method of communication between ships replenishing at sea?
1. Sound-powered phones
 2. Semaphore
 3. Megaphone
 4. Short-wave radio
- 3-48. What color is the daytime marker used to indicate that the distance between two ships is 140 feet?
1. Blue
 2. Green
 3. Red
 4. Yellow

3-49. How many blasts of a whistle should the receiving ship sound to indicate it is ready to receive the shot line?

1. One
2. Two
3. Three
4. Four

3-50. What is the color of the station marker used to indicate fuel oil is being transferred at this station?

1. Blue
2. Green
3. Orange
4. Red

3-51. Aircraft carriers fire the shot line to delivering ships because of the danger of hitting aircraft on the carrier's deck.

1. True
2. False

3-52. What rig is a high-speed transfer method developed for transferring cargo and missiles between ships at sea?

1. Burton
2. Housefall
3. Highline
4. STREAM

3-53. What equipment on the delivery ship travels vertically on a kingpost and lifts the load clear of obstructions before transfer?

1. Ram tensioner
2. Sliding pad eye
3. Sliding block
4. STREAM STAR

3-54. What type of highline is used to exchange personnel during replenishment at sea?

1. Burton
2. Housefall
3. Close-in
4. Synthetic

3-55. What danger signal should be sounded to initiate an emergency breakaway?

1. Five short blasts
2. Five long blasts
3. Four short blasts
3. Four long blasts

3-56. The only difference between day and night VERTREP is a reduction in the speed of operations due to decreases visibility.

1. True
2. False

IN ANSWERING QUESTIONS 3-57 THROUGH 3-60, SELECT THE HELMET COLOR IN COLUMN B THAT IS REQUIRED TO BE WORN DURING REPLENISHMENT BY THE PERSONNEL LISTED IN COLUMN A.

	<u>A. PERSONNEL</u>	<u>B. HELMET COLOR</u>
3-57.	Officers	1. Yellow
3-58.	Repair personnel	2. White
3-59.	Rig captain	3. Purple
3-60.	Winch operator	4. Brown

3-61. What bend is used to tie the gantline to the boatswains chair?

1. Becket
2. Double becket
3. Short splice
4. Rope yarn

3-62. When you are aloft in the boatswain's chair, what command should you give to inform the deck crew to let go of the gantline?

1. AVAST HEAVING
2. UP BEHIND
3. LET GO
4. GANTLINE

- 3-63. What device should you bend the tail of the gantline to when riding down standing rigging?
1. A pad eye
 2. A shackle
 3. A bitt
 4. A cleat
- 3-64. What officer must you receive permission from before going aloft?
1. Commanding officer
 2. Operations officer
 3. Communications officer
 4. Officer of the deck
- 3-65. When working over the side during welding, all safety rope lines should be replaced with wire rope.
1. True
 2. False
- 3-66. What device should be used to secure tools to personnel working over the side?
1. Lanyard
 2. Double becket
 3. Wire rope
 4. Snap hook
- 3-67. When properly rigged, what part(s) of the stage should support all the weight?
1. Horns
 2. Plank
 3. Gantlines
 4. Stage hitch
- 3-68. What is the approximate weight of a lead line?
1. 2 to 3 pounds
 2. 4 to 6 pounds
 3. 5 to 6 pounds
 4. 7 to 14 pounds
- 3-69. How deep is the water when the leadsman reports A QUARTER LESS THREE?
1. 2 3/4 fathoms
 2. 13 3/4 fathoms
 3. 16 3/4 fathoms
 4. 18 fathoms
- 3-70. What mooring line runs through the bullnose?
1. Stern
 2. Forward quarter
 3. After quarter
 4. Bow
- 3-71. What mooring lines are used to keep the ship from moving away from the pier?
1. Spring
 2. Breast
 3. Bow
 4. Stern
- 3-72. What should a line handler do when told to AVAST HEAVING?
1. Pay out the line
 2. Man his line
 3. Stop taking in
 4. Put line under tension
- 3-73. What officer must give you permission to work outside the lifelines when your ship is underway?
1. Commanding officer
 2. Communications officer
 3. Officer of the deck
 4. Operations officer
- 3-74. For what type of rigging is weather protection the only important consideration?
1. Boat davits
 2. Standing
 3. Running
 4. Single-sheaved

ASSIGNMENT 4

Textbook Assignment: "Boat Seamanship" and "Ammunition and Gunnery," chapters 5 and 6, pages 5-1 through 6-23.

- 4-1. What is the backbone of a boat's skeleton called?
1. The bilge
 2. The ribs
 3. The keel
 4. The cutwater
- 4-2. What is the name of the most forward part of a boat?
1. The cutwater
 2. The frame
 3. The beading
 4. The stem
- 4-3. Which boat is used as the lifeboat or as the utility boat?
1. Barge
 2. Gig
 3. Motor whaleboat
 4. Personnel boat
- 4-4. What type of boat is generally used for side cleaning duties?
1. Personnel
 2. Punt
 3. Utility
 4. Motor whaleboat
- 4-5. What is the equipment furnished with each boat called?
1. Accessories
 2. Standard parts
 3. Portable parts
 4. Gear assemblies
- 4-6. Where should you look to find the cargo and passenger capacities of the boat?
1. Boat label
 2. Boat log
 3. Coxswain's handbook
 4. Boat's alternate plan
- 4-7. To what officer is the coxswain responsible for the boat's cleanliness and readiness?
1. Executive officer
 2. Operation officer
 3. Engineering officer
 4. Division officer and the Officer of the deck
- 4-8. What individual usually issues instructions that set the uniform policy for boat crews?
1. JOOD
 2. OOD
 3. CDO
 4. SOPA
- 4-9. You are the bow hook on a small boat. Where should you be stationed when the boat is underway?
1. Aft lookout
 2. Forward lookout
 3. Mid ship
 4. By the coxswain
- 4-10. When a boat comes alongside a ship underway to be hoisted in, what line is attached to the boat first?
1. The bow line
 2. The frapping line
 3. The stern line
 4. The sea painter
- 4-11. When a boat is being lowered by crane, what device is used to cast the slings off the hook?
1. A boat hook
 2. A safety runner
 3. A sea painter
 4. A Raymond releasing hook

- 4-12. When a boat is hoisted with davits, what line should be kept in hand by each person aboard the boat?
1. Frapping
 2. Lanyard
 3. Manrope
 4. Strongback
- 4-13. What is the ideal landing approach for a single-screw boat?
1. Port-side-to, bow into current
 2. Port-side-to, stern into current
 3. Starboard-side-to, bow into current
 4. Starboard-side-to, stern into current
- 4-14. When there is sufficient maneuvering room, what is the best way to get a boat away from a starboard-side-to landing?
1. Go ahead until bow is clear
 2. Go ahead until stern is clear
 3. Back until the bow is clear
 4. Back until the stern is clear
- 4-15. What item does a small boat usually require to heave to in rough seas?
1. A drogue
 2. A grapnel
 3. A snap hook
 4. A broaching line
- 4-16. In a small boat carrying an officer for whom a salute is being fired, who should rise and salute?
1. The coxswain
 2. The person honored
 3. Everyone on board
 4. Everyone outside the canopy
- 4-17. You are a Seaman about to board a small boat with several officers. When should you enter the boat and where should you sit?
1. First; toward the stern
 2. First; toward the bow
 3. Last; toward the stern
 4. Last; toward the bow
- 4-18. When should the ensign be displayed aboard a small boat operating in a foreign port?
1. 0800 until sunset
 2. During daylight hours
 3. First boat run each day
 4. Whenever the boat is underway
- 4-19. The commanding officer of your ship is a commander. What flagstaff insignia should be displayed from his gig?
1. A flat truck
 2. A halberd
 3. A ball
 4. A star
- 4-20. You are the coxswain of a boat approaching your ship during daylight. One of your passengers is a captain. What signal should you make if you are hailed by the OOD?
1. Shout CAPTAIN, ARRIVING
 2. Hold up your arms with eight fingers extended
 3. Hold up your arms with six fingers extended
 4. Hold up your arms with four fingers extended
- 4-21. What boat hail should you call out to indicate that the Secretary of the Navy is embarked aboard your boat?
1. NAVY
 2. SECRETARY
 3. UNITED STATES
 4. FLAG OFFICER
- 4-22. You are the coxswain of the admiral's barge. Which of the following flaghoists would require you to return to the ship?
1. Qp0
 2. Qp1
 3. Qp2
 4. Qp3

- 4-23. What part of a ship should a coxswain use as the point of departure from a ship?
1. The ship's bow
 2. The anchor buoy
 3. The sea painter
 4. The accommodation ladder
- 4-24. When using a magnetic compass, what distance should the coxswain be from a ship before taking a magnetic compass reading?
1. 20 yd
 2. 50 yd
 3. 80 yd
 4. 100 yd
- 4-25. What term defines the amount of compass offset from true north and the direction of the Earth's magnetic fields?
1. Variation
 2. Deviation
 3. Compass error
 4. Correcting compass course
- 4-26. Assume true course, taken from a chart, is 030°; variation from the same chart is 3°W; and deviation from the same chart table is 2°W. What is the compass course?
1. 030°
 2. 032°
 3. 033°
 4. 035°
- 4-27. When two ships meet head on, each ship must change course to starboard to pass in what direction?
1. Port-to-port
 2. Port-to-starboard
 3. Starboard-to-port
 4. Starboard-to-starboard
- 4-28. What term describes a power-driven vessel that is in a crossing situation close enough to involve the risk of collision?
1. Constrained vessel
 2. Give-way vessel
 3. Stand-on vessel
 4. Crossing vessel
- 4-29. Your vessel has received the whistle signal of two prolonged blasts followed by one short blast. How should you acknowledge receipt of this signal?
1. One short blast
 2. One prolonged blast and one short blast
 3. One prolonged blast, one short blast, and one prolonged blast
 4. One prolonged blast, one short blast, one prolonged blast, and one short blast
- 4-30. What underway situation occurs when the mast of two vessels, when viewed from each other, are in line?
1. Crossing
 2. Meeting
 3. Overtaking
 4. Give-way
- 4-31. Under International Rules, a warning signal of one short blast by a ship's whistle has what meaning?
1. I AM ALTERING MY COURSE TO PORT
 2. I AM ALTERING MY COURSE TO STARBOARD
 3. I AM OPERATING ASTERN PROPULSION
 4. I AM DEAD IN THE WATER
- 4-32. What international whistle signal means I INTEND TO OVERTAKE YOU ON YOUR STARBOARD SIDE?
1. One short blast
 2. One prolonged blast
 3. One prolonged blast followed by one short blast
 4. Two prolonged blasts followed by one short blast

- 4-33. Signals given under International Rules of the Road are signals of intention only.
1. True
 2. False
- 4-34. A power-driven vessel is in international waters. Fog has set in, and you hear the fog sound signal of one prolonged blast at 2-minute intervals. What does this signal indicate?
1. I AM UNDERWAY WITH NO WAY ON
 2. I AM NOT UNDERWAY BUT MAKING WAY
 3. I AM UNDERWAY AND MAKING WAY
 4. I AM ANCHORED
- 4-35. A submarine fires a yellow flare. What does this signal indicate?
1. I REQUIRE ASSISTANCE
 2. I AM RISING TO PERISCOPE DEPTH
 3. I AM DIVING
 4. I AM OPERATING ASTERN PROPULSION
- 4-36. A vessel of less than 12 meters in length is NOT required to sound fog signals.
1. True
 2. False
- 4-37. The fog signals of inland and international waters are the same except Inland Rules do NOT provide for which of the following vessels?
1. Aground
 2. Anchored
 3. Constrained by draft
 4. Underway
- 4-38. Which of the following is a distress signal?
1. Two hoisted black balls
 2. A dye marker
 3. A FIVE flag flying
 4. A blast on the ship's whistle
- 4-39. What characteristic of a buoy is the chief indication of its purpose?
1. Size
 2. Shape
 3. Color
 4. Location
- 4-40. Which of the following IALA markings call attention to an area or specific feature?
1. Cardinal marks
 2. Lateral marks
 3. Safe water marks
 4. Special marks
- 4-41. Fairway and channel buoys are numbered odd to starboard and even to port approaching from seaward.
1. True
 2. False
- 4-42. What type of mark indicates the port and starboard side of the channel?
1. Lateral
 2. Cardinal
 3. Isolated danger
 4. Safe water
- 4-43. What device is used in conjunction with the cardinal mark to indicate the best navigable water?
1. A compass
 2. A chart
 3. A stadimeter
 4. A pelorus
- 4-44. What colors are used to identify cardinal marks?
1. Yellow and blue
 2. Yellow and green
 3. Black and yellow
 4. Black and white
- 4-45. What color identifies a special mark?
1. Black
 2. Green
 3. Red
 4. Yellow

- 4-46. Which of the following countries is covered under Region A of the IALA Maritime Buoyage System?
1. Japan
 2. Korea
 3. Europe
 4. Philippines
- 4-47. You observe a cardinal mark quick flashing every 10 seconds. What quadrant is indicated by this signal?
1. North
 2. East
 3. South
 4. West
- 4-48. You observe a white flashing light showing a group of two flashes. What mark does this signal indicate?
1. Safe water
 2. Special
 3. Isolated danger
 4. Cardinal
- 4-49. Intermediate caliber guns are greater than 8 inches in circumference.
1. True
 2. False
- 4-50. What color band identifies the ammunition used for training or firing practice?
1. Black
 2. Brown
 3. Light blue
 4. Light red
- 4-51. What is the length of the gun bore that fires a 5"/54 projectile?
1. 138 ft
 2. 190 ft
 3. 250 ft
 4. 270 ft
- 4-52. What is the classification of ammunition that has the cartridge case crimped around the base of the projectile?
1. Cased
 2. Fixed
 3. Semifixed
 4. Separated
- 4-53. What part of a projectile provides for maximum range and accuracy?
1. Ogive
 2. Bourrelet
 3. Rotating band
 4. Body
- 4-54. What type of projectile is designed for use against aircraft?
1. HIGH CAPACITY
 2. ANTI-AIRCRAFT
 3. COMMON
 4. PUFF
- 4-55. What type of projectile is designed for use against unarmored surface targets, shore installations, or personnel?
1. CHEMICAL
 2. PUFF
 3. HIGH CAPACITY
 4. ILLUMINATING
- 4-56. In fixed ammunition, the propelling charge and projectile are assembled together in a case and handled as one unit.
1. True
 2. False
- 4-57. What type of charge should be used when a gun is fired to render honors?
1. Bag
 2. Reduced
 3. Clearing
 4. Saluting

- 4-58. What type of fuze is energized after the projectile is fired and functions when the projectile nears the target?
1. Percussion
 2. Combination
 3. Proximity
 4. Time
- 4-59. What space aboard ship provides permanent stowage for parts of the ammunition allowance?
1. Primary magazines
 2. Secondary magazines
 3. Ready-service storage
 4. Ready-service magazines
- 4-60. A modern magazine sprinkler uses approximately how many gallons of water per square foot to wet down all exposed bulkheads?
1. 1
 2. 2
 3. 3
 4. 4
- 4-61. What is the primary marine location marker found aboard surface vessels?
1. Mk 58
 2. Mk 6
 3. Mk 5
 4. Mk 2
- 4-62. What is the approximate burning time of the Mk 58 marine location marker?
1. 10 to 20 min
 2. 20 to 30 min
 3. 30 to 40 min
 4. 40 to 60 min
- 4-63. During nighttime operations, what type of wad identifies the green Mk 2 marine illumination cartridge?
1. Smooth
 2. Small conical
 3. Corrugated
 4. Rough
- 4-64. To fire the Mk 5 pyrotechnic pistol, you should aim it at what desired angle?
1. 30°
 2. 45°
 3. 60°
 4. 90°
- 4-65. What NAVSEA publication contains information on the handling and storage of pyrotechnics?
1. SW050-AB-MMA-010
 2. S9086-US-STM-010
 3. S9086-TY-STM-000
 4. S9086-TW-STM-010
- 4-66. What action should be taken when a fuzeed projectile is dropped from a height of 5 feet?
1. Expend it at the first opportunity
 2. Set it aside to be returned to the ammunition shore facility
 3. Tag it and return it to the appropriate bin
 4. Throw it over the side
- 4-67. When inexperienced personnel are working with and handling ammunition, which of the following rules applies?
1. Personnel may not undertake such work until they have committed to memory and understand all applicable safety precautions
 2. Personnel must be under direct and continual supervision of skilled and experienced personnel
 3. Personnel may work alone only after receiving instructions in prescribed safety precautions, rules, and regulations
 4. Personnel may handle and inspect ammunition but are prohibited from adjusting live rounds

- 4-68. What part of the gun position equipment supports all of the elevating parts of the gun?
1. The base ring
 2. The slide
 3. The trunnion bearings
 4. The stand
- 4-69. What gun equipment includes all the components necessary to allow the gun to fire safely?
1. Positioning
 2. Firing
 3. Slide
 4. Gun carriage and trunnion bearing
- 4-70. What firing devices interrupt firing when the gun is pointed at the ship's permanent structure?
1. Firing circuits
 2. Firing cutouts
 3. Firing cutoffs
 4. Firing shutoffs
- 4-71. What device attaches the housing to the slide to prevent it from moving if system pressure is lost?
1. Safety link
 2. Recoil system
 3. Breechblock
 4. Housing link
- 4-72. The 5"/54 Mk 42 gun mount is capable of firing approximately how many rounds per minute?
1. 23
 2. 30
 3. 34
 4. 50
- 4-73. The only manned positions on the 5"/54 Mk 45 gun during normal operation are the mount captain and the loader room.
1. True
 2. False
- 4-74. What standard gunnery command means ammunition handlers in magazine crews fill hoist?
1. LOAD
 2. SILENCE
 3. COMMENCE FIRING
 4. RESUME FIRING
- 4-75. What standard gunnery command means to freeze in position while senior personnel remedy an unsafe condition?
1. CEASE FIRE
 2. SILENCE
 3. CHECK FIRE
 4. CARRY ON